



Price List 2024

FaustinosFurniture.com

323-724-8055

TABLE OF CONTENTS

Click text to jump page

<u>About</u>	3
<u>Contact</u>	4
<u>Order</u>	5
<u>Abbrev/Codes</u>	6
<u>Case Goods Features</u>	9
<u>Freight</u>	10
<u>Warranty</u>	11
<u>Terms</u>	12
<u>Policies</u>	13
<u>Forms</u>	15
<hr/>	
<u>Materials</u>	16
<u>Accessories</u>	23
<hr/>	
CLEARANCE → <u>Seating</u>	30
<u>Case Goods</u>	138
<u>Receptions</u>	258
<u>Tables</u>	279

Furniture Manufacturer in the USA since 1990 with products you can trust. [Back to main Tables of Contents](#)

We manufacture furniture to our network of authorized dealers who in turn provide excellent products and services to end-users of workplace settings. These spaces can include private and collaborative offices, conference and community rooms, lounge areas, and many more.

Southern California has been our home since our establishment. We began in Pico Rivera as a small manufacturer, and in 2004, moved to our current location in the City of Commerce — about 8 miles from east of Downtown Los Angeles — that gave us a larger facility to manufacture in.

Faustino's Furniture Manufacturing has a great history of providing service to customers that can be relied on. Completing projects in diverse furniture settings, from traditional to modern, has given our staff combined manufacturing and management experience in creating cost-effective products. We've been in business since 1990, and we understand what it takes to provide furniture for every application that suits each of your furnishing needs.

Our core product lines are Seating, Case Goods, Reception Units, and Tables with a focus on wood craftsmanship. We offer standard finishes to a wide range of materials that include laminate, veneer, hardwood, plywood, fabrics, vinyls, and leathers. Additionally, we can accommodate our customers own material (COM).

Reasons the shop with us:

- 33+ years in business
- 8 miles from Downtown Los Angeles
- Design assistance
- Lead times
- Customs





Furniture made for:

- Professional or Home Office
- Hospitality
- Conference
- Lobby
- Medical

Faustino's Furniture Manufacturing would like to make clear to its clients that errors in the Price List can occur. For this reason, Faustino's retains the right to modify pricing and text contained in this Price List to its clients at any time for reasons which may include but not limited to: typographical errors; product placement; changes in cost of goods; etc. We work extremely hard to make certain this does not happen, but if it may to occur, we apologize for the inconvenience it may cause. Please contact a Representative from Faustinos to verify pricing on items to ensure it is accurate before offering final pricing to your clientele.

CONTACT

[Back to main Tables of Contents](#)

	PURCHASE ORDERS ORDER STATUS PRODUCT QUESTIONS GENERAL QUESTIONS	CustomerService <i>@faustinoschair.com</i>
	QUOTES NEW DEALERS NEW PROJECTS	Sales <i>@faustinoschair.com</i>
	FAX	(323) 724-8056
	PHONE	(323) 724-8055

HOW TO ORDER

[Back to main Tables of Contents](#)

Email POs to **customerservice@faustinoschair.com**

ACKNOWLEDGEMENT ORDER DESCRIPTION

Our acknowledgements, packing slips, and invoices, will have the description written out as in this example:

PONY 2448-3HGLS1-G1(R) OAK

WHAT THAT MEANS AND HOW TO WRITE YOUR DESCRIPTIONS ON YOUR PO

When you place an order write as much description of the product as possible. A helpful way to re-assure the dimensions and type of product you are ordering is to include the quick model and size code seen on the left side of a price sheet. Also, include the codes seen from the materials and accessories sheets in this price list. See example below:

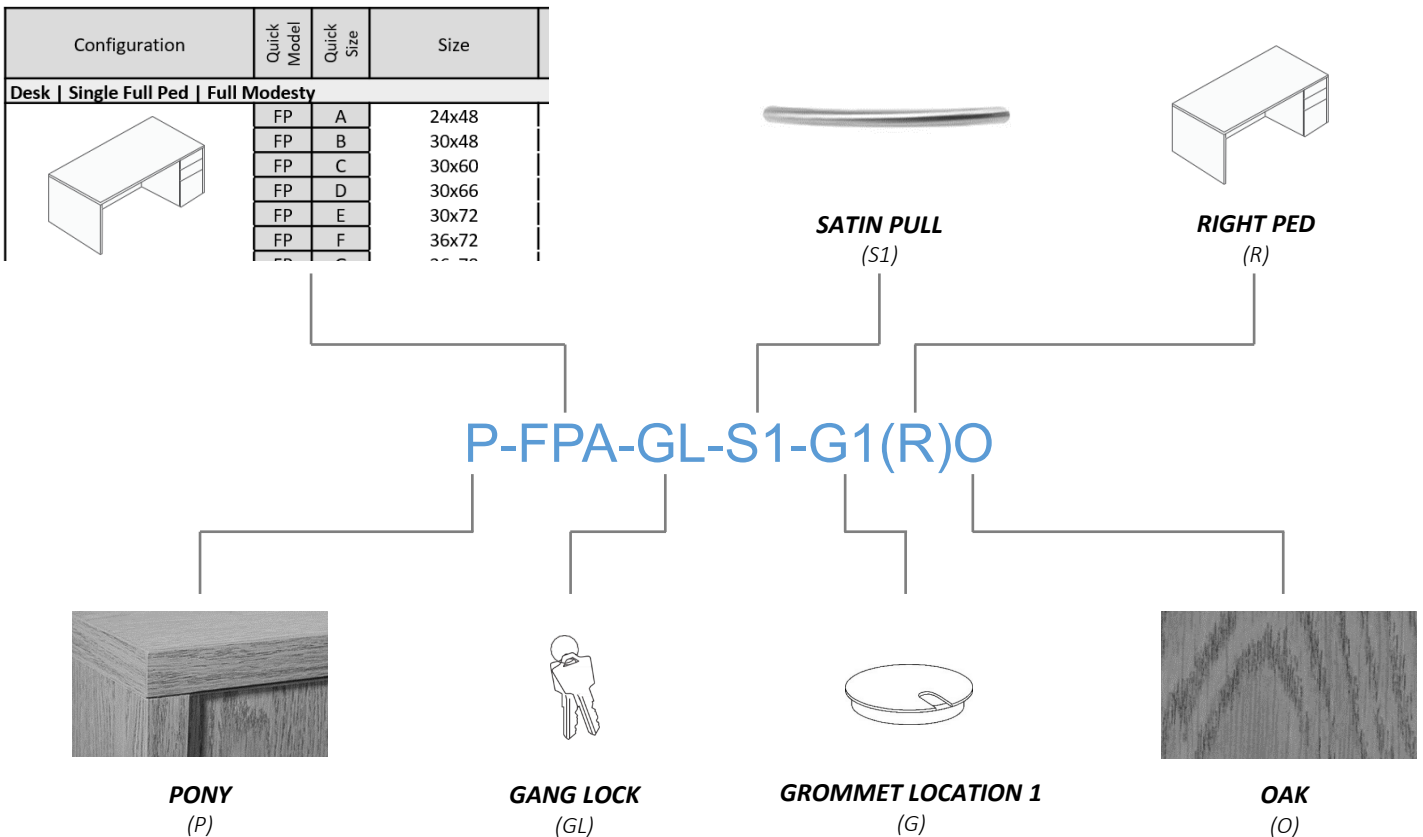

ABBREVIATIONS & CODES

Abbreviations of Key Words and Options

[Back to main Tables of Contents](#)

2D	Box/File
3D	Box/Box/Box
4D	Box/Box/Box/Box
3H	Box/Box/File
2H	File/File
2LS	Legal File/File
LF	Lateral File
PLF	Personal Lateral File
PP	Personal Printer
PPD	Personal Printer w/Door
CP	CPU Holder
HD	Hinged Doors Cabinet
SD	Sliding Doors Cabinet
CD	Center Drawer
FT	Fan Top
K22	22" Keyboard
K28	28" Keyboard
5VP	Metal 5-Prong Wood-Clad & Column Veneer Wrap
4P	Metal 4-Prong Black Base
SP	Silver-Post
BP	Black Post
WD	Wardrobe Option #1
WDL	Wardrobe Option #2
WDR	Wardrobe Option #3
LM	Locking Mechanism

KB	Kick Base
VP	Veneer-Wrapped Post
FM	Full Modesty Panel
GTB	Grommet Black
GTS	Grommet Silver
GL	Ganglock
PL	Pedestal Lock
FL	Face Lock
BCS	Bookcase Section
BS	Bookcase Shelf
RG	Receptionist Gallery
DS	Diction Slide
FCB	Full Cylinder Base
HCB	Half Cylinder Base
RC	Radial Corner
SB	Stretcher Bar
LI	In Stock Laminate Inlay
HPL	High-Pressure Laminate
FLR/B	For Left Return or Bridge
FRR/B	For Right Return or Bridge
(L)	Left
(R)	Right
(SLP)	Single Left Ped
(SRP)	Single Right Ped

ABBREVIATIONS & CODES

Finish Codes

[Back to main Tables of Contents](#)

Wood Veneer Finishes

Amber.....	AV
Blackwash.....	BW
Cherry on Cherry.....	CC
Cocoa.....	CV
Cognac.....	XV
Espresso.....	EV
Greywash.....	GW
Honey Cherry.....	HC
Koala.....	KV
Light Cherry.....	LC
Light Oak.....	LO
Mahogany.....	MV
Medium Oak.....	MO
Medium Mahogany.....	MM
Natural Cherry.....	NC
Natural Maple.....	NM
Natural Oak.....	NO
Natural Walnut.....	NW
Pecan.....	PV
Rustic.....	RV
Sienna.....	SV
Sunburst.....	SUV
Walnut.....	WV
Whitewash.....	WW

Laminate Finishes

Black.....	B
Charcoal.....	A
Cognac.....	X
Espresso.....	K
Graphite.....	R
Grey.....	D
Mahogany.....	M
Maple.....	E
Lakewood.....	Q
Oak.....	O
Seaboard.....	S
White.....	Z
Wild Cherry.....	H

Alder Wood Finishes *(for select seating)*

A-Black.....	AB
A-Cognac.....	AX
A-Espresso.....	AE
A-Honey.....	AH
A-Light Cherry.....	ALC
A-Mahogany.....	AM
A-Oak.....	AO
A-Sienna.....	AS
A-Seaboard.....	ASE
A-Walnut.....	AW
A-White.....	AZ

ABBREVIATIONS & CODES

Edge Detail Codes

[Back to main Tables of Contents](#)

Wood Veneer Edge Details

Aristocrat.....	(A)
Row.....	(R)
Row 2.....	(R2)
Row-Fluted.....	(RF)
Row-Saga.....	(RS)
Row-Beveled.....	(RB)
Row-Reverse Beveled.....	(RRB)
Victory.....	(VV)
Fluted.....	(FV)
Saga.....	(SV)
Square.....	(ASQ)
Beveled.....	(BV)
Matrix.....	(MV)
Concord with Saga edge.....	(CV)
Concord with Aristocrat edge.....	(CVA)
Concord with Beveled edge.....	(CVB)
Concord with 1-1/4" Fluted edge.....	(CVF)
Concord with 2" Row edge.....	(CVR)
Concord with 2" Row-Fluted edge.....	(CVRF)
Concord with 2" Row-Saga edge.....	(CVRS)

Laminate Edge Details

Pony.....	(P)
Flow.....	(W)
Echo.....	(E)
Victory-L.....	(VL)
Fluted.....	(FL)
Saga.....	(SL)
Square.....	(ESQ)
Beveled.....	(BL)
Matrix.....	(ML)
Concord with Saga edge.....	(CLS)
Concord with Echo edge.....	(CLE)
Concord with Beveled edge.....	(CLB)
Concord with 1-1/4" Fluted edge.....	(CLF)
Concord with 2" Row edge.....	(CLR)
Concord with 2" Row-Fluted edge.....	(CLRF)
Concord with 2" Row-Saga edge.....	(CLRS)

CASE GOODS FEATURES & OPTIONS

[Back to main Tables of Contents](#)

Type	LAMINATE	LAMINATE W/WOOD EDGE				WOOD VENEER			
Series	<i>Pony</i>	<i>Flow</i>	<i>Echo</i>	<i>Fluted-L</i>	<i>Concord-L</i>	<i>Aristocrat</i>	<i>Row</i>	<i>Fluted-V</i>	<i>Concord-V</i>
Edges	Pony	Flow	Echo Beveled Square Matrix	Fluted-L Saga-L	Concord-L* Victory-L	Aristocrat Beveled Square Matrix	Row Row 2 Row-Beveled Row-Reverse-Beveled Row-Fluted Row-Saga	Fluted-V Saga-V	Concord-V* Victory-V
Top Surface	Thermafuse Laminate					Veneer			
Top Edge	PVC Edge	Solid Wood: 1-1/8"				Solid Wood: 1-1/4"	Solid Wood: 2"	Solid Wood: 1-1/4"	
End Panel Edge	PVC Edge					Veneer			
Modesty Panel	TF Laminate					Veneer			
Pedestals	Hanging				Floor* Hanging	Hanging			Floor* Hanging
Pedestal Side	TF Laminate					Veneer			
Drawer-Front	TF Laminate					Veneer			
Drawer-Interior	Birch Veneer								
Dictation Slide	Optional								
Center Drawer	Optional								
Keyboard	Optional								
Drawer Slides	BIFMA Certified								
Box Drawer Slide	100 lbs., Ball Bearing, Full Extension								
File Drawer Slide	100 lbs., Ball Bearing, Full Extension								
Lateral File	150 lbs., Ball Bearing, Full Extension								
Vertical File	150 lbs., Ball Bearing, Full Extension								
Pedestal Lock	One Lock Standard on Main Desk only								
Face Lock	Standard on Lateral & Vertical Files								
Drawer Pulls	Optional				Standard on Concord	Optional			Standard on Concord
Pulls on Lat/Vert Files	Standard					Optional			Standard on Concord
Finishes	Black (B) Charcoal (A) Cognac (X) Espresso (K) Graphite (R) Grey (D) Lakewood (Q) Mahogany (M) Maple (E) Oak (O) Seaboard (S) Spectrum Grey (P) White (Z) Wild Cherry (H)					Amber (AB) Blackwash (BW) Cherry on Cherry (CC) Cocoa (CV) Cognac (XV) Espresso (EV) Honey Cherry (HC) Greywash (GW) Koala (KV) Light Cherry (LC) Light Oak (LO) Mahogany (MV) Med. Mahogany (MM) Med. Oak (MO) Nat. Cherry (NC) Nat. Oak (NO) Natural Maple (NM) Natural Walnut (NW) Pecan (PV) Rustic (RV) Sienna (SV) Sunburst (SUV) Walnut (WV) Whitewash (WV)			

FREIGHT

[Back to main Tables of Contents](#)

FOB/Freight

Our facility is located 8 miles east of Downtown Los Angeles. All orders placed are FOB WILL CALL or FREIGHT COLLECT. The carrier of choice must be specified on the order and freight charges are per agreement between parties responsible for payment. All weights are BLANKET-WRAP and sizes are approximate. Will Call hours are from 8am-3pm.

Carton and palletizing are available upon request with additional charge.

Note:

Please use the approximate lead times below as a guide when you plan your purchase, but always confirm between us before placing your order.

Seating

Seating in grade "A" will be ready to ship in 1-2 weeks.

Seating in grade "B", "C", "D", "E", and Leather will be ready to ship in 2-3 weeks.

Seating in high-volume QTY, COM and in special design are TBD.

Case Goods/Receptions/Tables

All case goods are made-to-order and will be ready to ship anywhere from 1-6 weeks.

Please see details below.

Laminate case goods: 1-2 weeks

Laminate receptions: 2-4 weeks

Laminate conf. tables: 2-3 weeks

Veneer case goods: 4-5 weeks

Veneer receptions: 4-6 weeks

Veneer conf. tables: 4-5 weeks

Case goods in high-volume QTY and special design/material are TBD.

WARRANTY

[Back to main Tables of Contents](#)

Timeline

Faustino's Furniture Manufacturing (Faustino's) warrants its cataloged products from this website and its price list to the original purchaser from the date of original invoice for: a period of 10 years on structural integrity and workmanship. A period of 2 years on hardware, application of finish, and upholstery.

Craftsmanship

Because environmental conditions, cleaning procedures, and other conditions of use are beyond our control, this warranty does not extend to color fastness and durability of finish color or upholstery.

Receival

A copy of Faustino's original invoice must accompany any request for warranty or parts after Faustino's inspection of subject item; it is Faustino's option whether charges will apply. Due to the fact of natural variations in wood product, this warranty does not extend to grain, texture, or color of laminates or wood.

Dealers Only

This warranty is made by Faustino's only to authorized dealers acquiring our products directly from Faustino's. Faustino's obligation and purchaser claim pursuant to this warranty are limited to repair or replacement at Faustino's option.

Usage

Faustino's warranty is only valid if the products are given normal and proper use for which it was intended and designed for. Faustino's assumes no responsibility for repairs to products sustaining damage from misuse, abuse, handling, alterations, or negligence.

Warranty Parts

All repairs or replacement parts are F.O.B.; Faustino's must make any abatement to this in writing.

Conclusion

There are no other warranties except as expressly set forth above, either expressed or implied, including any warranty or merchantability, fitness, or any particular purpose. Faustino's shall not be liable for incidental or consequential damage arising from product defects, non-delivery, or other breach by Faustino's.

TERMS & CONDITION OF SALE

[Back to main Tables of Contents](#)

All prices are F.O.B. factory with standard wood finishes. This price list supersedes any previous one. Faustino's reserves the right to accept or refuse any order. If invoices are not paid according to Faustino's Terms of Sale, invoices will be charged with the higher interest permitted by law. Faustino's will hold in-house orders without notice for past-due accounts until accounts are brought current. First time NSF check: Faustino's will invoice \$50. Second NSF check: Faustino's will invoice \$100 and will change account to 50% in advance with P.O. and CASHIER'S CHECK before product ships. Faustino's will invoice to customer if products are not will-call within 7 days from notification date of orders ready for will call.

POLICIES

[Back to main Tables of Contents](#)

Title

The product manufactured by Faustino's does not pass to the purchaser and shall remain the property of Faustino's until subject purchase is paid for in full in legal tender. The customer agrees to perform all actions necessary to protect Faustino's title to said product until paid. All accounts past due will be prosecuted to the full extent of the law, which will include all attorney fees incurred.

How to Order

All orders can be placed by phone if the customer so decides, but must be confirmed in writing by email, or fax. Our office will acknowledge receipt of order in writing (email) within (3) working days. If a special design, alteration or modification is needed, we request you provide a quick (and simple) sketch of the item(s) in the order. Your order placement must show the proper "series" including the correct arrangement per item. Configurations are derived from, as sitting position (as if you were using the item). A copy of this acknowledgement acts as a shop order. The customer must revise this confirmation and advise in writing (email) immediately in the event of any discrepancy between item ordered and acknowledgement, otherwise acknowledgment prevails.

Damaged Goods

It is the customer's responsibility to examine the incoming goods. If there is any damage or discrepancies, it must be noted on the carriers signed receipt; claims must be immediately filed by receiver with carrier. Notification must be sent to factory within 48 hours of receipt. Faustino's is not responsible for losses or damage to the product out of our possession, which may occur in transit, handling, or storage.

Invoice Payment Deductions

Invoice deductions cannot be honored unless previously authorized IN WRITING by Faustino's authorized personnel. You may request credit if Faustino's manufactured defective and/or shipped wrong furniture. For reasons other than manufactured defective and/or shipped wrong furniture, Faustino's will not accept credit requests. Deductions taken without previously authorized will create confusion and will cause us to hold orders until accounts are brought current. After we receive your credit request and agree, we will do everything possible to send you a credit memo by fax within one week provided that the furniture has been returned to Faustino's warehouse and/or we have all paperwork to validate your request for credit. This will include comments from our sales representatives regarding conditions of the furniture and pictures of any factory defects if applicable, etc.

POLICIES

[Back to main Tables of Contents](#)

Receipt of Goods

Prices published are subject to change without notice. Please confirm with your rep before purchase to confirm price on an order. Possession of price list does not constitute an offer to sell. Orders must be picked up within 3 days of notice. Carriers must schedule in advance with Faustino's for date and time of pick-up.

COM Material

All Customer Own Materials sent to Faustino's must be properly labeled with customer name, purchase order number, fabric identification and supplier. Order acknowledgments cannot have scheduled completion date until all required materials are in factory. Faustino's will "wait" for fabric to arrive, it is the customer's responsibility to track their own materials. Failure to label fabric will cause delays on order completion. Fabric requirement requests must be accompanied by sample cutting of fabric, stating direction applied, and direction coming off of roll. Fabric received without proper application instructions will be applied at Faustino's best discretion and is not negotiable.

Faustino's Special Finishes

All Special Finish orders, must be accompanied with finish sample. Samples sent to Faustino's must be Properly labeled with customer name and purchase order number. Order acknowledgments cannot have Scheduled completion date until all required samples are in factory. Faustino's will "wait" for samples to arrive, it is the customers responsibility to track their own samples. Failure to label samples will cause delays on order completion. As with all natural wood products, exact matches are not guaranteed. Some models may not be available in all wood species; substitutions will be made at Faustino's discretion.

Faustino's Guarantee

Keep commitment on lead-time completion date. Ship orders complete or notify in advance of change. Factory direct sales to dealers only.

Pictures, Line Drawings, Prices and Specifications

The pictures and line drawings in this price list shows basic item configuration in support for the website color picture. Please report to us any discrepancies in price and/or specifications in this price list and we will provide clarification and revisions as soon as possible.

Repair Charges

Authorization must be obtained from Faustino's Customer Service Department prior to incurring repair charges if Faustino's is expected to pay all or part of these charges.

Returns

Do not return furniture without written (email) consent and shipping instructions from Faustino's. Merchandise returned without authorization will not be accepted.

Freight

All orders placed will be sent FREIGHT COLLECT, carrier must be specified on order, and freight charges are per agreement between parties responsible for payment.

FORMS - COM

[Back to main Tables of Contents](#)

Customer's Own Material (COM) Information Sheet

Please copy this page, complete the form, and mail it with the COM purchase order.

Dealer Information

Dealer Name

Address

Phone

Dealer Contact Name

Fabric Information

Mill/Supplier

Model/Fabric Number

Color

Pattern Description (if any)

Chair/Model #

Total Number of Chairs

Yardage per Unit





Total Yardage Needed

NOTE: Yardage requirements specified in this price list are based on a standard 54" wide fabric that is non-directional in nature. If your fabrics is directional or has a repeating pattern, you must get a quote from Faustino's before you place your order.

If your fabric has a stripe or repeating pattern, please attach a sample of the fabric below to show how to apply the fabric to the chair. Use on sheet per COM fabrics.

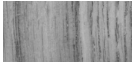
Click text to jump page

[*Back to main Tables of Contents*](#)

<i>pg. 17</i>	<u>LAMINATE</u>	
<i>pg. 18</i>	<u>WOOD VENEER/CHAIR FINISHES</u>	
<i>pg. 19</i>	<u>ALDER</u> <i>(For select seating)</i>	
<i>pg. 20</i>	<u>FABRICS/LEATHERS/VINYLS</u>	
<i>pg. 21</i>	<u>DATA/POWER MODULES</u>	
<i>pg. 22</i>	<u>PULLS</u>	

MATERIALS – LAMINATE

[Back to main Tables of Contents](#)



Black
(B)



Charcoal
(A)

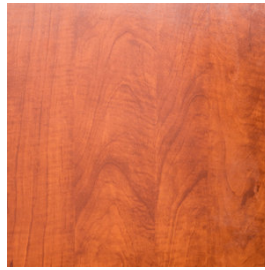

Cognac
(X)



Espresso
(K)

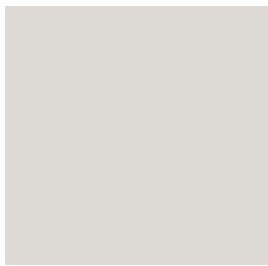

Grey
(D)



Lakewood
(Q)

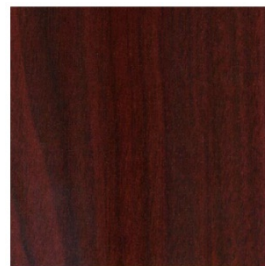

Mahogany
(M)



Maple
(E)



Oak
(O)

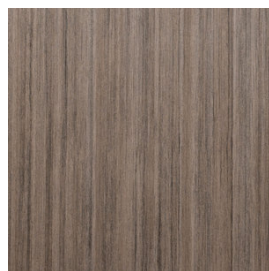

Seaboard
(S)

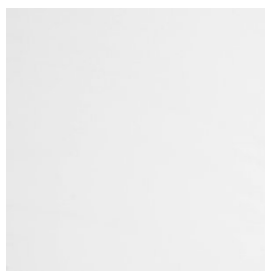

White
(Z)

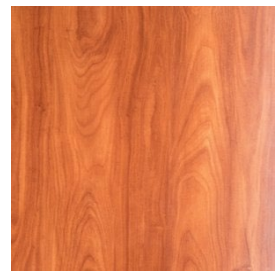

Wild Cherry
(H)

These colors represent casegoods options. May be available upon seating by request.

These samples are to represent basic color and grain only.

MATERIALS – WOOD VENEER/CHAIR FINISHES

[Back to main Tables of Contents](#)

Oak



Natural Oak
(NO)

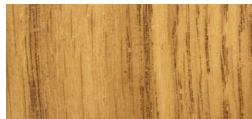

Medium Oak
(MO)



Light Oak
(LO)

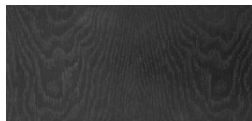

Blackwash
(BW)

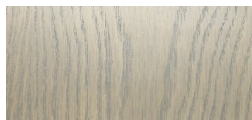

Greywash
(GW)



Whitewash
(WW)

Walnut



Natural Walnut
(NW)

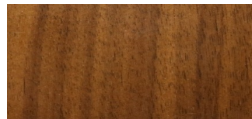

Walnut
(WV)

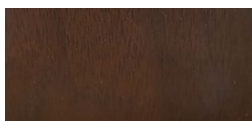

Espresso
(EV)

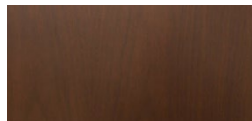

Sienna
(SV)

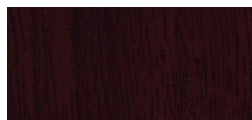

Mahogany
(MV)

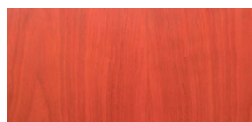

Medium Mahogany
(MM)

Cherry



Natural Cherry
(NC)



Honey Cherry
(HC)

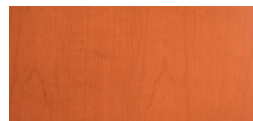

Cherry on Cherry
(CC)

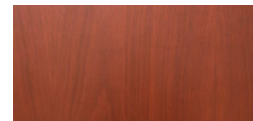

Light Cherry
(LC)

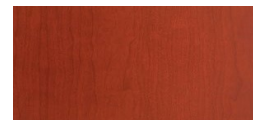

Cognac
(XV)

Maple



Natural Maple
(NM)

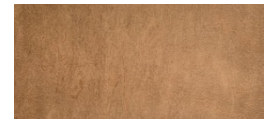

Rustic
(RV)

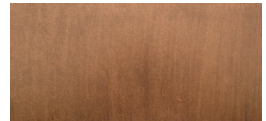

Cocoa
(CV)

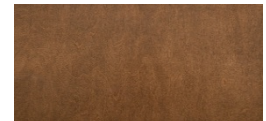

Pecan
(PV)

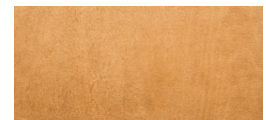

Koala
(KV)



Amber
(AV)

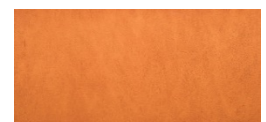

Sunburst
(SUV)

These colors both represent casegoods and seating options.

As wood is a natural product, color and grain will vary per unit and with time. These samples are to represent basic color and grain only.

MATERIALS – ALDER WOOD FINISHES

These finishes are available for select seating.

[Back to main Tables of Contents](#)



A-Seaboard
(ASE)

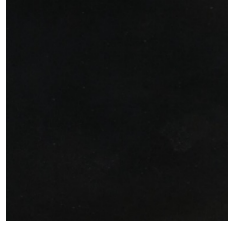

A-Black
(AB)

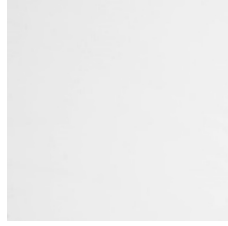

A-White
(AZ)

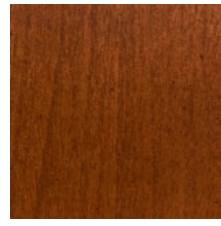

A-Honey
(AH)

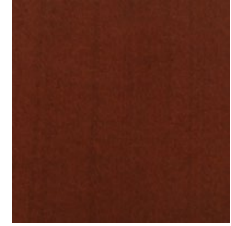

A-Light Cherry
(ALC)

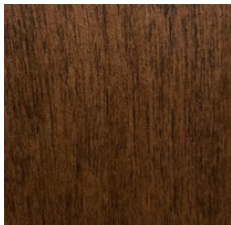

A-Walnut
(AW)

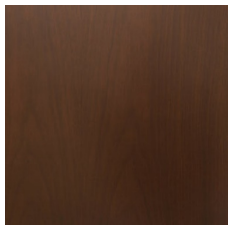

A-Sienna
(AS)

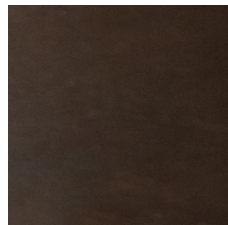

A-Espresso
(AE)

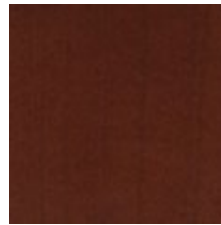

A-Cognac
(AX)

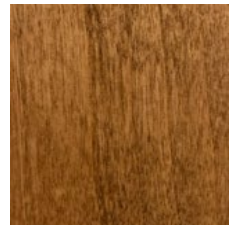

A-Oak
(AO)

These finishes are available for select seating. Individual seating price sheet will show if alder finish is available.

As wood is a natural product, color and grain will vary per unit and with time. These samples are to represent basic color and grain only.

MATERIALS – FABRICS/LEATHERS/VINYLS

[Back to main Tables of Contents](#)

Note:

Please visit our website pages for selections:

<https://www.faustinosfurniture.com/fabrics>

<https://www.faustinosfurniture.com/all-leathers>

<https://www.faustinosfurniture.com/leather-combo>

<https://www.faustinosfurniture.com/vinyls>

MATERIALS – DATA/POWER MODULES

[Back to main Tables of Contents](#)

DAPO1 Power Module

Price
\$278 List

Specifications

Electrical Rating: AC 120V/ 60Hz, 10A/ 15A
 USB Output (when applicable): DC 5V 2.1A/
 4.2A Max
 Cord Length: 10 feet

Note:

Indicate power port location with P.O.
 Cost includes cutout



3-1/2"



3-3/8"

3"

DAPO2 Power Module

Price
\$667 List

Specifications

2x AC Plug (6ft cord)
 2x USB Charging Ports
 1x 2.0 HDMI Port
 1x 3.0 USB Pass Through
 1x Data (Cat6)
 1x Phone Jack (RJ11)
 110 Volt, 10 Amp, 1100 Watts Rated Load
 Flush-Mount 180 Degree Rotation
 UL Listed



11-3/4"



4-3/8"

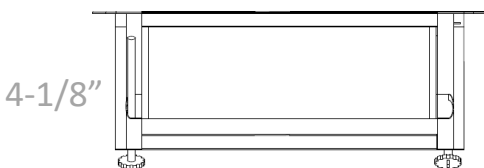

4-1/8"

10-3/8"

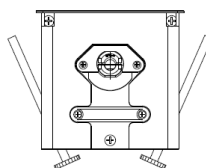

4"



MATERIALS – PULLS

[Back to main Tables of Contents](#)

Standard

Price
\$20



Satin Pull
(S1)



Black Pull
(B1)



Antique Pull
(A1)



Majestic Pull
(M1)



Waterfall Pull
(W1)



Presidential Pull
(P1)



Satin Knob
(KS)



Black Knob
(KB)



Antique Knob
(KA)



Nickle Knob
(KN)



Presidential Knob
(KP)

Premium

Price
\$37



Bar Pull
(B2)



Nickle Pull
(N1)



Nickle Pull
(N2)



Satin Pull
(S2)







Roll Silver
(S3)



Black Pull
(B3)

Click text to jump page

[Back to main Tables of Contents](#)

<i>pg. 24</i>	<u>LOCKING/BOOKCASE/ DRAWER</u>	
<i>pg. 25</i>	<u>GROMMETS</u>	
<i>pg. 26</i>	<u>WHITEBOARDS/ TACKBOARDS</u>	
<i>pg. 27</i>	<u>CHAIR MECHANISMS</u>	
<i>pg. 28</i>	<u>ADDITIONAL</u>	

ACCESSORIES – LOCKING/BOOKCASE/DRAWER

[Back to main Tables of Contents](#)

Face lock: Locks single drawer or door	(FL) \$43
Gang Face Lock: Locks two hinged doors	(GFL) \$67
Pedestal Lock: Placed on side of pedestal; Locks 2D, 3D, 2H, 3H (Specify Left or Right from sitting position)	(PL) \$109
Gang Lock: Placed on top front drawer; Locks 2D, 3D, 2H, 3H 2-Drawer Vertical or Lateral File	(GL) \$109
Interlock A: Placed on top front drawer; Locks 3-Drawer Vertical or Lateral File. Will open only one drawer at a time and keeps other drawers close.	(ILA) \$194
Interlock B: Placed on top front drawer; Locks 4-Drawer Vertical or Lateral File. Will open only one drawer at a time and keeps other drawers closed.	(ILB) \$279
Optional: Locks keyed # different than standard number	\$19 per Lock
Locking Mechanism	(LM) \$279

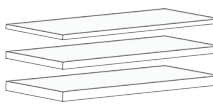
Configuration	Quick Model	Quick Size	Laminate	Veneer
Bookcase Shelf				
	BS1	3/4"	43	116
	BS2	1-1/8"	85	-
	BS3	1-1/4"	-	170

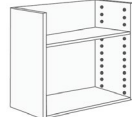
Configuration	Quick Model	Quick Size	Laminate	Veneer
Bookcase Section				
	BCS		328	643

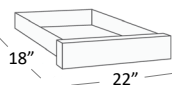
Configuration	Quick Model	Quick Size	Laminate	Veneer
Center Drawer				
	CD		158	210

ACCESSORIES – GROMMETS

[Back to main Tables of Contents](#)

Configuration	Quick Model	Quick Size	Black	Silver
Grommet – Black or Silver				
	GT	B	63	-
	GT	S	-	69



Grommet Location Codes

When adding grommets, write the corresponding grommet location code after the Quick Size code, and before the Finish code.
 Example: The code "(P)SAG1-O" indicates that the grommet, "G" would be placed at location "1" according to the chart below.

(P) S A G 1 - O

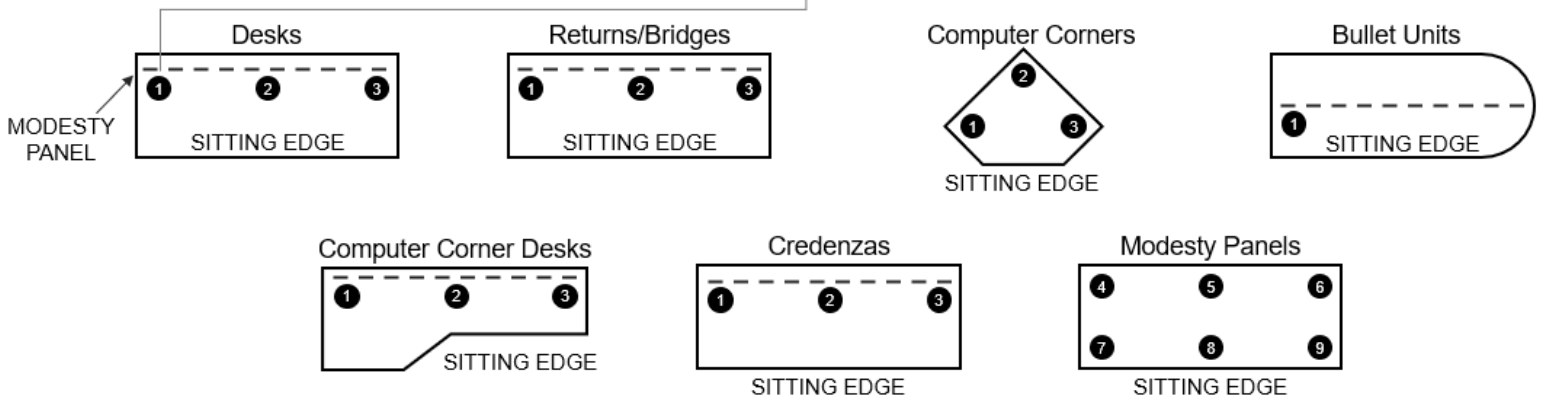

ACCESSORIES – WHITE BOARDS/TACK BOARDS

[Back to main Tables of Contents](#)

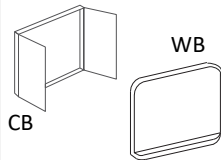
Configuration	Quick Model	Quick Size	Size	Pony	Echo	Fluted-L	Victory-L	Carton	B-Weight	Cube
Conference & White Board - Laminate										
	CB	A	48x48	1,718	1,929	2,144	2,245	204	135	8
	WB	A	24x48	-	728	-	-	139	34	2
	WB	B	48x48	-	1,091	-	-	139	68	3

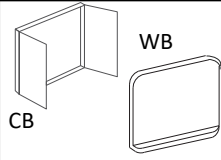
Configuration	Quick Model	Quick Size	Size	Aristocrat	Row	Fluted-V	Victory-V	Carton	B-Weight	Cube
Conference & White Board - Veneer										
	CB	A	48x48	2,188	2,732	2,580	2,850	204	135	8
	WB	A	24x48	728	-	-	-	139	34	2
	WB	B	48x48	1,091	-	-	-	139	68	3

Configuration	Quick Model	Quick Size	Size	No Fabric	Grade "A"	Grade "B" /COM	Grade "C"	Grade "D"	Grade "E"	Carton
Tack Board										
	TB	A	24x36	189	280	302	354	402	504	60
	TB	B	24x48	254	378	428	477	530	631	68
	TB	C	24x60	316	428	477	530	580	681	79
	TB	D	24x66	378	477	530	580	631	731	87
	TB	E	24x72	439	530	580	631	681	781	97
	TB	F	24x78	504	580	631	681	731	833	108



NOTE
Tackboards can be installed by Faustino's on hutches by request at no charge.

BUTTON-CAPS
Optional \$3 list each upholstered button-cap to cover screws.

Proper screws to install tackboard must provided by installers

ACCESSORIES – CHAIR MECHANISMS

[Back to main Tables of Contents](#)

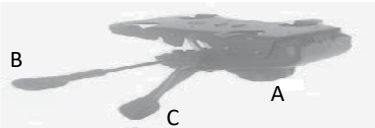
#11	 <p>A top-down view of a chair mechanism. A central vertical post is labeled 'A', and a horizontal adjustment lever is labeled 'B'.</p>	<p>A. Tilt Tension Adjustment B. Pneumatic Height Adjustment</p>	\$141
#12	 <p>A top-down view of a chair mechanism. A central vertical post is labeled 'A', and a horizontal adjustment lever is labeled 'B'.</p>	<p>A. Tilt Tension Adjustment B. Pneumatic Height and Tilt Lock Adjustment</p>	\$236
#13	 <p>A top-down view of a chair mechanism. A central vertical post is labeled 'A', and a horizontal adjustment lever is labeled 'B'.</p>	<p>A. Tilt Tension Adjustment B. Pneumatic Height Adjustment (Non-Locking)</p>	\$194
#14	 <p>A top-down view of a chair mechanism. A central vertical post is labeled 'A', a horizontal adjustment lever is labeled 'B', and a small rectangular lock is labeled 'C'.</p>	<p>A. Tilt Tension Adjustment B. Pneumatic Height Adjustment C. Position Tilt Lock</p>	\$382

ACCESSORIES - ADDITIONAL

[Back to main Tables of Contents](#)

PNEUMATIC LIFTS

3" Pneumatic Lift	\$72
5" Pneumatic Lift	\$104
10" Pneumatic Lift	\$158

EXTRA CHAIR WIDTH or DEPTH

2" Extra Width on Sled Base or Leg Side Chair	\$170
2" Extra Depth on Sled Base or Leg Side Chair	\$170
2" Extra Width on **Medium or High Back Swivel Chair	\$213
2" Extra Depth on **Medium or High Back Swivel Chair	\$213
2" Extra Height	\$170
** It is highly recommended to add a 27" metal base and a #14 heavy duty mechanism.	

HARDWARE

Standard Caster	\$7
Soft Caster	\$12
Glide	\$19
Brass Caster	\$9
Gang Connector Kit Hardware (connects 2 chairs)	\$91







FABRICS

Grade "A" Fabric or Vinyl	\$66/yd
Grade "B" Fabric or Vinyl	\$100/yd
Grade "C" Fabric or Vinyl	\$129/yd
Grade "D" Fabric or Vinyl	\$195/yd
Grade "E" Fabric or Vinyl	\$410/yd

SEATING

Click text to jump page

[Back to main Tables of Contents](#)

<i>pg. 31</i>	<u>IN-STOCK</u> CLEARANCE	
<i>pg. 35</i>	<u>EXECUTIVE</u>	
<i>pg. 44</i>	<u>GUEST</u>	
<i>pg. 99</i>	<u>LOUNGE</u>	
<i>pg. 117</i>	<u>RECEPTION</u>	
<i>pg. 130</i>	<u>TRADITIONAL</u>	

[Back to main Tables of Contents](#)

Click image to jump page

CLEARANCE

1. Until quantities last.
2. First come first serve basis.
3. Please call factory for availability.

QTY	DISCOUNT
1-10	20% OFF
11-20+	30% OFF

 4LB	 4CB	 11EX
pg. 32	pg. 33	pg. 34

TABLE OF CONTENTS



4LB

Model#	4LB	Model#	4LB
Overall Depth (in)	24	COM (yards)	1.00
Overall Width	22	Carton (\$)	37
Seat Width	19	B-Weight (lbs)	22
Seat Depth	17	Cube (in ³)	11
Seat Height	17		
Back Height	31		
Arm Height	25		

Note: Width and depth are inside dimensions

Series	Model #	Type	A	B / COM	C	D	E	Leather Combo	All Leather
In Stock	Light Multi-purpose Stackable Chair								
	4LB	Stackable Black Arms Leg Chair	330	370	410	445	500		570

CLEARANCE

1. Until quantities last.
2. First come first serve basis.
3. Please call factory for availability.

QTY

1-10

11-20+

DISCOUNT

20% OFF

30% OFF

TABLE OF CONTENTS



Model#	4CB	Model#	4CB
Overall Depth (in)	24	COM (yards)	1.00
Overall Width	22	Carton (\$)	37
Seat Width	19	B-Weight (lbs)	22
Seat Depth	17	Cube (in ³)	11
Seat Height	19		
Back Height	33		
Arm Height	25		

Note: Width and depth are inside dimensions

Series	Model #	Type	A	B / COM	C	D	E	Leather Combo	All Leather
In Stock	Light Multi-purpose Stackable Chair w/Casters								
	4CB	Stackable Black/Silver Arms Leg Chair w/Casters	355	400	435	475	525		600

CLEARANCE

1. Until quantities last.
2. First come first serve basis.
3. Please call factory for availability.

QTY
1-10
11-20+

DISCOUNT
20% OFF
30% OFF

TABLE OF CONTENTS



11EX

Model#	11EX	Model#	11EX
Overall Depth (in)	25	COM (yards)	1.00
Overall Width	26	Carton (\$)	39
Seat Width	20	B-Weight (lbs)	49
Seat Depth	19	Cube (in ³)	9
Seat Height	19		
Back Height	46-49		
Arm Height	25		

Note: Width and depth are inside dimensions

Series	Model #	Type	Black Vinyl	A	B / COM	C	D	E	Leather Combo	All Leather
In Stock		Polished Chrome Base								
	11EX	Ex - High Back Chair	665	-	-	-	-	-	-	-

CLEARANCE

1. Until quantities last.
2. First come first serve basis.
3. Please call factory for availability.

QTY
1-10
11-20+

DISCOUNT
20% OFF
30% OFF



TABLE OF CONTENTS

EXECUTIVE SEATING

[Back to main Tables of Contents](#)

Click image to jump page

 #2400	 #3700	 #5700
<i>pg. 36</i>	<i>pg. 37</i>	<i>pg. 38</i>

 #7900	 #9020
<i>pg. 39</i>	<i>pg. 40</i>

 #9300	 #9600	 #9700
<i>pg. 41</i>	<i>pg. 42</i>	<i>pg. 43</i>

TABLE OF CONTENTS



2405

Model#		Model#	
2404	2405	2404	2405
Overall Depth (in)		COM (yards)	
29	33	1.75	2.25
Overall Width		Carton (\$)	
22	22	56	56
Seat Width		B-Weight (lbs)	
20	20	36	42
Seat Depth		Cube (in ³)	
19	19	13	13
Seat Height			
19	19		
Back Height			
35	42		
Arm Height			
25	25		

Note: Width and depth are inside dimensions



Series	Model #	Type	A	B / COM	C	D	E	Leather Combo	All Leather
Executive 2400	Diamond Stitching on Back Mech #11 5" Pneumatic Lift								
	2404	Jr Ex - Low Back Chair	895	950	1,005	1,115	1,240	1,240	1,380
	2405	Ex - High Back Chair	945	990	1,050	1,200	1,360	1,360	1,640

TABLE OF CONTENTS



3705

Model#		Model#	
3704	3705	3704	3705
Overall Depth (in)		COM (yards)	
28	28	2.00	2.50
Overall Width		Carton (\$)	
24	24	56	56
Seat Width		B-Weight (lbs)	
20	20	40	45
Seat Depth		Cube (in ³)	
19	19	16	13
Seat Height			
19	19		
Back Height			
40	44		
Arm Height			
27	27		

Note: Width and depth are inside dimensions



Series	Model #	Type	A	B / COM	C	D	E	Leather Combo	All Leather
Executive 3700	Cross Stitching on Back & Seat High Resilient Foam Mech #12 3" Pneumatic Lift								
	3704	Jr Ex - Low Back Chair	1,195	1,225	1,260	1,475	1,570	1,590	1,700
	3705	Ex - High Back Chair	1,315	1,360	1,405	1,570	1,805	1,805	1,980

TABLE OF CONTENTS



5704

Model#		Model#	
5703	5704	5703	5704
Overall Depth (in)		COM (yards)	
30	33	2.00	2.50
Overall Width		Carton (\$)	
24	24	56	56
Seat Width		B-Weight (lbs)	
20	20	38	43
Seat Depth		Cube (in ³)	
20	20	13	18
Seat Height			
20	20		
Back Height			
34	43		
Arm Height			
25	25		

Note: Width and depth are inside dimensions



Series	Model #	Type	A	B / COM	C	D	E	Leather Combo	All Leather
Executive 5700	Stitching on Back Bentwood Arms Mech #11 5" Pneumatic Lift								
	5703	Jr Ex - Low Back Chair	800	850	870	1,010	1,120	1,120	1,260
	5704	Ex - High Back Chair	945	1,025	1,060	1,165	1,330	1,330	1,600

TABLE OF CONTENTS



7905

Model#		Model#	
7904	7905	7904	7905
Overall Depth (in)		COM (yards)	
30	33	3.50	4.00
Overall Width		Carton (\$)	
24	24	56	56
Seat Width		B-Weight (lbs)	
20	20	39	44
Seat Depth		Cube (in ³)	
20	20	15	18
Seat Height			
19	19		
Back Height			
38	44		
Arm Height			
26	26		

Note: Width and depth are inside dimensions



Series	Model #	Type	A	B / COM	C	D	E	Leather Combo	All Leather
Executive 7900	Arm Wrap with Tufted Seat & Back Mech #11 5" Pneumatic Lift								
	7904	Jr Ex - Low Back Chair	1,225	1,355	1,405	1,660	1,895	1,895	2,490
	7905	Ex - High Back Chair	1,430	1,570	1,630	1,910	2,175	2,175	2,760



TABLE OF CONTENTS



9025

Model#		Model#	
9024	9025	9024	9025
Overall Depth (in)		COM (yards)	
29	29	1.75	2.25
Overall Width		Carton (\$)	
23	23	56	56
Seat Width		B-Weight (lbs)	
20	20	36	42
Seat Depth		Cube (in ³)	
19	19	13	13
Seat Height			
20	20		
Back Height			
38	44		
Arm Height			
25	25		

Note: Width and depth are inside dimensions

Series	Model #	Type	A	B / COM	C	D	E	Leather Combo	All Leather
Executive 9020	V-Stitching Curved Arms								
	9024	Jr Ex - Low Back Chair	840	905	950	1,090	1,215	1,215	1,465
	9025	Ex - High Back Chair	880	960	1,010	1,140	1,255	1,255	1,510

*Note: Pricing shows alder wood in, A-Sienna, A-Espresso, A-Mahogany, and A-Light Cherry
Add \$140 list for Walnut, Cherry, Oak, or Maple Wood
Add \$121 list for Dura Surface*

TABLE OF CONTENTS



9305

Model#		Model#	
9304	9305	9304	9305
Overall Depth (in)		COM (yards)	
30	30	2.50	3.00
Overall Width		Carton (\$)	
24	24	56	56
Seat Width		B-Weight (lbs)	
20	20	23	39
Seat Depth		Cube (in ³)	
20	20	16	19
Seat Height			
20	20		
Back Height			
40	46		
Arm Height			
26	26		

Note: Width and depth are inside dimensions



Series	Model #	Type	A	B / COM	C	D	E	Leather Combo	All Leather
Executive 9300 Lumbar Back Support and Lumbar Cushions High Resilient Foam Mech #12 3" Pneumatic Lift									
	9304	Jr Ex - Low Back Chair	1,450	1,510	1,570	1,735	1,895	1,860	2,115
	9305	Ex - High Back Chair	1,600	1,670	1,750	1,885	2,080	2,070	2,455

TABLE OF CONTENTS



9605

Model#		Model#	
9604	9605	9604	9605
Overall Depth (in)		COM (yards)	
29	29	2.00	2.50
Overall Width		Carton (\$)	
23	23	56	56
Seat Width		B-Weight (lbs)	
20	20	40	45
Seat Depth		Cube (in ³)	
19	19	15	18
Seat Height			
20	20		
Back Height			
38	44		
Arm Height			
25	25		

Note: Width and depth are inside dimensions



Series	Model #	Type	A	B / COM	C	D	E	Leather Combo	All Leather
Executive 9600	High Resilient Foam Mech #12 3" Pneumatic Lift								
	9604	Jr Ex - Low Back Chair	1,270	1,335	1,405	1,570	1,750	1,750	2,025
	9605	Ex - High Back Chair	1,360	1,435	1,510	1,665	1,875	1,875	2,295

TABLE OF CONTENTS



9705

Model#		Model#	
9704	9705	9704	9705
Overall Depth (in)		COM (yards)	
30	30	2.50	3.00
Overall Width		Carton (\$)	
24	24	56	56
Seat Width		B-Weight (lbs)	
20	20	40	44
Seat Depth		Cube (in ³)	
20	20	16	19
Seat Height			
20	20		
Back Height			
40	46		
Arm Height			
25	25		

Note: Width and depth are inside dimensions



Series	Model #	Type	A	B / COM	C	D	E	Leather Combo	All Leather
Executive 9700	Classic Stylings & Curved Arms High Resilient Foam Mech #12 3" Pneumatic Lift								
	9704	Jr Ex - Low Back Chair	1,385	1,445	1,505	1,660	1,825	1,740	1,995
	9705	Ex - High Back Chair	1,535	1,605	1,680	1,805	2,010	1,945	2,335

TABLE OF CONTENTS

GUEST SEATING

[Back to main Tables of Contents](#)

Click image to jump page

 #1	 #1AA	 #2	 #700
pg. 48	pg. 49	pg. 50	pg. 51
 #710	 #715	 #720	 #725
pg. 52	pg. 53	pg. 54	pg. 55
 #730	 #735	 #740	 #745
pg. 56	pg. 57	pg. 58	pg. 59
 #750	 #755	 #1000	 #1100
pg. 60	pg. 61	pg. 62	pg. 63

Guest Seating continued on next page...

TABLE OF CONTENTS

GUEST SEATING

[Back to main Tables of Contents](#)

Click image to jump page

 #1150	 #1160/70	 #1200	 #1500
pg. 64	pg. 65	pg. 66	pg. 67
 #1600	 #1900	 #2000	 #2400
pg. 68	pg. 69	pg. 70	pg. 71
 #3500	 #3700	 #5000	 #5500
pg. 72	pg. 73	pg. 74	pg. 75
 #5700	 #6500	 #7500	 #7900
pg. 76	pg. 77	pg. 78	pg. 79

Guest Seating continued on next page...

TABLE OF CONTENTS

GUEST SEATING

[Back to main Tables of Contents](#)

Click image to jump page

 #8000-1	 #8000-2	 #8000-3	 #8000-4
pg. 80	pg. 81	pg. 82	pg. 83
 #8600	 #8610	 #8700	 #8800
pg. 84	pg. 85	pg. 86	pg. 87
 #9000	 #9011/15	 #9020	 #9030
pg. 88	pg. 89	pg. 90	pg. 91
 #9300	 #9500	 #9520	 #9600
pg. 92	pg. 93	pg. 94	pg. 95

Guest Seating continued on next page...

[Back to main Tables of Contents](#)

Click image to jump page



 #9700	 #FCF1	 #FCF11
pg. 96	pg. 97	pg. 98

TABLE OF CONTENTS



1LWSDS

Model#	1LWS/1LWSDS	Model#	1LWS/1LWSDS
Overall Depth (in)	26	COM (yards)	1.75
Overall Width	23	Carton (\$)	40
Seat Width	20	B-Weight (lbs)	23
Seat Depth	19	Cube (in ³)	12
Seat Height	19		
Back Height	32		
Arm Height	26		

Note: Width and depth are inside dimensions



Series	Model #	Type	A	B / COM	C	D	E	Leather Combo	All Leather
Guest 1	WS – Wall Saver DS – Dura-Surface								
	1LWS	Leg Chair	690	740	795	855	955	955	1,085
	1LWSDS	Leg Chair	805	855	910	970	1,070	1,070	1,200

TABLE OF CONTENTS



1AAL

Model#	1AAL/1AALDS	Model#	1AAL/1AALDS
Overall Depth (in)	26	COM (yards)	2.00
Overall Width	24	Carton (\$)	40
Seat Width	20	B-Weight (lbs)	26
Seat Depth	19	Cube (in ³)	12
Seat Height	20		
Back Height	35		
Arm Height	26.5		

Note: Width and depth are inside dimensions



Series	Model #	Type	A	B / COM	C	D	E	Leather Combo	All Leather
Guest 1AA	AA – A Frame DS – Dura-Surface								
	1AAL	Leg Chair	735	780	840	910	990	990	1,120
	1AALDS	Leg Chair	850	900	955	1,025	1,110	1,110	1,235

TABLE OF CONTENTS



2LWS

Model#	2LWS/2LWSDS	Model#	2LWS/2LWSDS
Overall Depth (in)	26	COM (yards)	2.00
Overall Width	24	Carton (\$)	40
Seat Width	20	B-Weight (lbs)	23
Seat Depth	19	Cube (in ³)	13
Seat Height	19		
Back Height	33		
Arm Height	26		

Note: Width and depth are inside dimensions



Series	Model #	Type	A	B / COM	C	D	E	Leather Combo	All Leather
Guest 2	Curved Legs Curved-Knuckle Arms WS – Wall Saver DS – Dura-Surface								
	2LWS	Leg Chair	920	965	1,025	1,085	1,185	1,185	1,320
	2LWSDS	Leg Chair	1,035	1,080	1,140	1,200	1,300	1,300	1,435

TABLE OF CONTENTS



701

Model#					
701	702	703	704	706	707
Overall Depth (in)					
23	23	26	26	23	23
Overall Width					
18	18	22	22	18	18
Seat Width					
16	16	20	20	16	16
Seat Depth					
16	16	20	20	16	16
Seat Height					
19	19	19	19	29	19
Back Height					
32	32	32	32	43	32
Arm Height					

Model#					
701	702	703	704	706	707
COM (yards)					
1.00	1.00	1.50	1.50	1.00	1.00
Carton (\$)					
40	40	40	40	67	40
B-Weight (lbs)					
19	19	22	22	28	19
Cube (in ³)					
11	11	11	11	10	11

Note: Width and depth are inside dimensions







Series	Model #	Type	A	B / COM	C	D	E	Leather Combo	All Leather
Guest 700	Armless 3/4th Back								
	701	Armless (small)	350	380	405	445	530	530	665
	702	Armless w/Casters (small)	380	410	435	480	555	555	700
	703	Armless (large)	420	455	480	530	610	610	750
	704	Armless w/Casters (large)	445	485	510	560	640	625	765
	706	Stool	490	515	540	585	665	665	800
	707	2 Position Armless (small)	445	475	500	545	630	630	695

TABLE OF CONTENTS



710

Model#			
710-L	710-2G	710-3G	710-4G
Overall Depth (in)			
27	27	27	27
Overall Width			
22	43	64	85
Back Height			
32	32	32	32

Model#			
710-L	710-2G	710-3G	710-4G
COM (yards)			
2.00	4.00	6.00	8.00
Carton (\$)			
40	86	130	174
B-Weight (lbs)			
21	38	57	76
Cube (in ³)			
11	21	31	41

Note: Width and depth are inside dimensions





Series	Model #	Type	A	B / COM	C	D	E	Leather Combo	All Leather
Guest 710	Armless 3/4th Back Straight Back Legs								
	710-L	Leg Chair	355	400	415	490	565	565	710
	710-2G	2-Seater	720	790	830	980	1,140	1,140	1,420
	710-3G	3-Seater	1,085	1,190	1,235	1,470	1,710	1,710	2,125
	710-4G	4-Seater	1,445	1,575	1,650	1,965	2,285	2,285	2,840

TABLE OF CONTENTS



715

Model#				
715-L	715-2G	715-3G	715-4G	715-B
Overall Depth (in)				
27	27	27	27	27
Overall Width				
22	43	64	85	32
Back Height				
32	32	32	32	32

Model#				
715-L	715-2G	715-3G	715-4G	715-B
COM (yards)				
2.00	4.00	6.00	8.00	3.00
Carton (\$)				
40	86	130	174	146
B-Weight (lbs)				
21	38	57	76	30
Cube (in ³)				
11	21	31	41	16

Note: Width and depth are inside dimensions





Series	Model #	Type	A	B / COM	C	D	E	Leather Combo	All Leather
Guest 715	Standard 3/4th Back								
	715-L	Leg Chair	380	420	435	520	595	595	735
	715-2G	2-Seater	765	840	870	1,030	1,190	1,190	1,465
	715-3G	3-Seater	1,145	1,255	1,315	1,550	1,780	1,780	2,200
	715-4G	4-Seater	1,530	1,675	1,750	2,065	2,380	2,380	2,935
	715-B	Bariatric Chair	885	960	990	1,150	1,315	1,315	1,585

TABLE OF CONTENTS







Model#				
720-L	720-2G	720-3G	720-4G	720-B
Overall Depth (in)				
27	27	27	27	27
Overall Width				
23	44	65	86	33
Back Height				
32	32	32	32	32

Model#				
720-L	720-2G	720-3G	720-4G	720-B
COM (yards)				
2.00	4.00	6.00	8.00	3.00
Carton (\$)				
40	86	130	174	146
B-Weight (lbs)				
21	38	57	76	30
Cube (in ³)				
11	21	31	41	16

Note: Width and depth are inside dimensions

720

Series	Model #	Type	A	B / COM	C	D	E	Leather Combo	All Leather
Guest 720		Slanted Arms 3/4th Back							
	720-L	Leg Chair	425	460	500	595	720	720	850
	720-2G	2-Seater	850	920	990	1,190	1,435	1,435	1,695
	720-3G	3-Seater	1,275	1,385	1,495	1,780	2,140	2,140	2,545
	720-4G	4-Seater	1,695	1,845	1,990	2,380	2,860	2,860	3,395
	720-B	Bariatric Chair	990	1,070	1,140	1,335	1,575	1,575	1,845

Note: Pricing shows in alder wood

Add \$56 list per arm for Walnut, Cherry, Oak, or Maple Wood

TABLE OF CONTENTS







725

Model#				
725-L	725-2G	725-3G	725-4G	725-B
Overall Depth (in)				
27	27	27	27	27
Overall Width				
23	44	65	86	33
Back Height				
32	32	32	32	32

Model#				
725-L	725-2G	725-3G	725-4G	725-B
COM (yards)				
2.00	4.00	6.00	8.00	3.00
Carton (\$)				
40	86	130	174	146
B-Weight (lbs)				
21	38	57	76	30
Cube (in ³)				
11	21	31	41	16

Note: Width and depth are inside dimensions

Series	Model #	Type	A	B / COM	C	D	E	Leather Combo	All Leather
Guest 725	Slanted Arms Full-Back								
	725-L	Leg Chair	460	500	535	630	750	750	885
	725-2G	2-Seater	920	990	1,070	1,260	1,505	1,505	1,770
	725-3G	3-Seater	1,385	1,495	1,600	1,890	2,250	2,250	2,655
	725-4G	4-Seater	1,845	1,990	2,130	2,525	3,010	3,010	3,540
	725-B	Bariatric Chair	1,040	1,115	1,190	1,385	1,630	1,630	1,890

Note: Pricing shows in alder wood

Add \$56 list per arm for Walnut, Cherry, Oak, or Maple Wood

TABLE OF CONTENTS



730

Model#				
730-L	730-2G	730-3G	730-4G	730-B
Overall Depth (in)				
27	27	27	27	27
Overall Width				
24	46	68	90	34
Back Height				
32	32	32	32	32

Model#				
730-L	730-2G	730-3G	730-4G	730-B
COM (yards)				
2.00	4.00	6.00	8.00	3.00
Carton (\$)				
40	86	130	174	146
B-Weight (lbs)				
21	38	57	76	30
Cube (in ³)				
11	21	31	41	17

Note: Width and depth are inside dimensions





Series	Model #	Type	A	B / COM	C	D	E	Leather Combo	All Leather
Guest 730	Straight-Back Legs Slanted-Front Legs 3/4th Back								
	730-L	Leg Chair	405	435	460	555	690	690	830
	730-2G	2-Seater	800	870	920	1,190	1,385	1,385	1,650
	730-3G	3-Seater	1,200	1,315	1,385	1,675	2,075	2,075	2,475
	730-4G	4-Seater	1,600	1,750	1,845	2,230	2,720	2,720	3,295
	730-B	Bariatric Chair	920	990	1,040	1,235	1,505	1,505	1,770

TABLE OF CONTENTS



735

Model#				
735-L	735-2G	735-3G	735-4G	735-B
Overall Depth (in)				
27	27	27	27	27
Overall Width				
24	46	68	90	34
Back Height				
32	32	32	32	32

Model#				
735-L	735-2G	735-3G	735-4G	735-B
COM (yards)				
2.00	4.00	6.00	8.00	3.00
Carton (\$)				
40	86	130	174	146
B-Weight (lbs)				
21	38	57	76	30
Cube (in ³)				
11	21	31	41	17

Note: Width and depth are inside dimensions





Series	Model #	Type	A	B / COM	C	D	E	Leather Combo	All Leather
Guest 735	Straight-Back Legs Slanted-Front Legs Full-Back								
	735-L	Leg Chair	435	475	500	595	730	730	860
	735-2G	2-Seater	870	950	990	1,190	1,455	1,455	1,710
	735-3G	3-Seater	1,315	1,420	1,495	1,780	2,185	2,185	2,585
	735-4G	4-Seater	1,750	1,890	1,990	2,380	2,910	2,910	3,445
	735-B	Bariatric Chair	990	1,070	1,115	1,315	1,575	1,575	1,845

TABLE OF CONTENTS





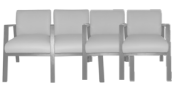

Model#				
740-L	740-2G	740-3G	740-4G	740-B
Overall Depth (in)				
27	27	27	27	27
Overall Width				
24	46	68	90	34
Back Height				
32	32	32	32	32

Model#				
740-L	740-2G	740-3G	740-4G	740-B
COM (yards)				
2.00	4.00	6.00	8.00	3.00
Carton (\$)				
40	86	130	174	146
B-Weight (lbs)				
21	38	57	76	30
Cube (in ³)				
11	21	31	41	17

Note: Width and depth are inside dimensions

740

Series	Model #	Type	A	B / COM	C	D	E	Leather Combo	All Leather
Guest 740	Standard Curved-Arms 3/4th Back								
	740-L	Leg Chair	445	485	525	620	740	740	870
	740-2G	2-Seater	900	970	1,040	1,235	1,475	1,475	1,750
	740-3G	3-Seater	1,345	1,455	1,565	1,860	2,220	2,220	2,620
	740-4G	4-Seater	1,795	1,945	2,085	2,475	2,960	2,960	3,495
	740-B	Bariatric Chair	1,020	1,090	1,190	1,355	1,600	1,600	1,870

Note: Pricing shows in alder wood

Add \$56 list per arm for Walnut, Cherry, Oak, or Maple Wood

TABLE OF CONTENTS







Model#				
745-L	745-2G	745-3G	745-4G	745-B
Overall Depth (in)				
27	27	27	27	27
Overall Width				
24	46	68	90	34
Back Height				
32	32	32	32	32

Model#				
745-L	745-2G	745-3G	745-4G	745-B
COM (yards)				
2.00	4.00	6.00	8.00	3.00
Carton (\$)				
40	86	130	174	146
B-Weight (lbs)				
21	38	57	76	30
Cube (in ³)				
11	21	31	41	17

Note: Width and depth are inside dimensions

745

Series	Model #	Type	A	B / COM	C	D	E	Leather Combo	All Leather
Guest 745	Standard Curved-Arms Full-Back								
	745-L	Leg Chair	485	525	555	655	775	775	910
	745-2G	2-Seater	970	1,040	1,115	1,315	1,555	1,555	1,820
	745-3G	3-Seater	1,455	1,565	1,675	1,965	2,325	2,325	2,730
	745-4G	4-Seater	1,945	2,085	2,165	2,620	3,105	3,105	3,640
	740-B	Bariatric Chair	1,090	1,165	1,235	1,435	1,675	1,675	1,945

Note: Pricing shows in alder wood

Add \$56 list per arm for Walnut, Cherry, Oak, or Maple Wood

TABLE OF CONTENTS







Model#				
750-L	750-2G	750-3G	750-4G	750-B
Overall Depth (in)				
27	27	27	27	27
Overall Width				
24	46	68	90	34
Back Height				
32	32	32	32	32

Model#				
750-L	750-2G	750-3G	750-4G	750-B
COM (yards)				
2.00	4.00	6.00	8.00	3.00
Carton (\$)				
40	86	130	174	146
B-Weight (lbs)				
21	38	57	76	30
Cube (in ³)				
11	21	31	41	17

Note: Width and depth are inside dimensions

750

Series	Model #	Type	A	B / COM	C	D	E	Leather Combo	All Leather
Guest 750		V-Stitching Curved-Arms 3/4th Back							
	750-L	Leg Chair	475	510	545	645	765	765	900
	750-2G	2-Seater	950	1,020	1,090	1,285	1,530	1,530	1,795
	750-3G	3-Seater	1,420	1,530	1,640	1,930	2,295	2,295	2,690
	750-3G	4-Seater	1,890	2,040	2,185	2,565	3,055	3,055	3,590
	750-B	Bariatric Chair	1,070	1,140	1,215	1,405	1,650	1,650	1,915

Note: Pricing shows in alder wood

Add \$56 list per arm for Walnut, Cherry, Oak, or Maple Wood

TABLE OF CONTENTS







755

Model#				
755-L	755-2G	755-3G	755-4G	755-B
Overall Depth (in)				
27	27	27	27	27
Overall Width				
24	46	68	90	34
Back Height				
32	32	32	32	32

Model#				
755-L	755-2G	755-3G	755-4G	755-B
COM (yards)				
2.00	4.00	6.00	8.00	3.00
Carton (\$)				
40	86	130	174	146
B-Weight (lbs)				
21	38	57	76	30
Cube (in ³)				
11	21	31	41	17

Note: Width and depth are inside dimensions

Series	Model #	Type	A	B / COM	C	D	E	Leather Combo	All Leather
Guest 755 V-Stitching Curved-Arms Full-Back									
	755-L	Leg Chair	510	545	585	675	800	800	930
	755-2G	2-Seater	1,020	1,090	1,165	1,355	1,600	1,600	1,870
	755-3G	3-Seater	1,530	1,640	1,750	2,040	2,405	2,405	2,800
	755-4G	4-Seater	2,040	2,185	2,325	2,720	3,205	3,205	3,740
	755-B	Bariatric Chair	1,140	1,215	1,285	1,475	1,720	1,720	1,990

Note: Pricing shows in alder wood

Add \$56 list per arm for Walnut, Cherry, Oak, or Maple Wood

TABLE OF CONTENTS



1001

Model#	1001, 1002, 1003	Model#	1001, 1002, 1003
Overall Depth (in)	26	COM (yards)	1.50
Overall Width	22	Carton (\$)	40
Seat Width	20	B-Weight (lbs)	21
Seat Depth	19	Cube (in ³)	11
Seat Height	19		
Back Height	32		
Arm Height	26		

Note: Width and depth are inside dimensions



Series	Model #	Type	A	B / COM	C	D	E	Leather Combo	All Leather
Guest 1000	Standard 3/4th Back								
	1001	Leg Chair	400	430	445	525	610	610	745
	1002	Leg Caster Chair	425	460	480	550	635	635	770
	1003	Sled Base Chair	400	430	445	525	610	610	745

TABLE OF CONTENTS



1101

Model#	1101, 1102, 1103	Model#	1101, 1102, 1103
Overall Depth (in)	26	COM (yards)	1.50
Overall Width	22	Carton (\$)	40
Seat Width	20	B-Weight (lbs)	21
Seat Depth	19	Cube (in ³)	11
Seat Height	19		
Back Height	32		
Arm Height	26		

Note: Width and depth are inside dimensions



Series	Model #	Type	A	B / COM	C	D	E	Leather Combo	All Leather
Guest 1100	Radius Wood Edge Arms								
	1101	Leg Chair	420	455	475	545	630	630	600
	1102	Leg Caster Chair	445	480	500	580	660	660	800
	1103	Sled Base Chair	420	455	475	545	630	630	770

TABLE OF CONTENTS



1153

Model#	1151, 1152, 1153	Model#	1151, 1152, 1153
Overall Depth (in)	26	COM (yards)	1.50
Overall Width	22	Carton (\$)	40
Seat Width	20	B-Weight (lbs)	21
Seat Depth	19	Cube (in ³)	11
Seat Height	19		
Back Height	32		
Arm Height	26		

Note: Width and depth are inside dimensions



Series	Model #	Type	A	B / COM	C	D	E	Leather Combo	All Leather
Guest 1150	All Radius Arms-Legs Triple Stitching								
	1151	Leg Chair – 3/4 Back	640	690	710	855	1,005	1,005	1,135
	1152	Leg Caster Chair – 3/4 Back	665	685	740	885	1,025	1,025	1,170
	1153	Sled Base Chair – Full Back	665	720	750	885	1,025	1,025	1,170

TABLE OF CONTENTS



1161

Model#	1161/1171	Model#	1161/1171
Overall Depth (in)	25	COM (yards)	2.00
Overall Width	23	Carton (\$)	40
Seat Width	20	B-Weight (lbs)	23
Seat Depth	19	Cube (in ³)	12
Seat Height	19		
Back Height	32		
Arm Height	26		

Note: Width and depth are inside dimensions





Series	Model #	Type	A	B / COM	C	D	E	Leather Combo	All Leather
Guest 1160/1170	Standard Curved Arms								
	1161	Leg Chair – ¾ Back	585	630	690	765	850	850	980
	1162	Leg Caster Chair – ¾ Back	620	665	730	800	885	885	1,020
	1171	Leg Chair – Full Back	610	655	720	790	870	870	1,010
	1172	Leg Caster Chair – Full Back	645	690	750	830	910	910	1,040

TABLE OF CONTENTS



1201

Model#	Model#		
1201, 1202, 1203	1201	1202	1203
Overall Depth (in)	COM (yards)		
26	2.50	2.50	3.00
Overall Width	Carton (\$)		
24	40	40	40
Seat Width	B-Weight (lbs)		
20	26	26	38
Seat Depth	Cube (in ³)		
19	13	13	13
Seat Height			
19			
Back Height			
35			
Arm Height			
26			

Note: Width and depth are inside dimensions



Series	Model #	Type	A	B / COM	C	D	E	Leather Combo	All Leather
Guest 1200	All Radius Arms-Legs Upholstered Arm Inserts Concealed Fasteners								
	1201	Leg Chair – 3/4 Back	735	790	805	950	1,090	1,090	1,365
	1202	Leg Caster Chair – 3/4 Back	765	815	840	980	1,125	1,125	1,405
	1203	Sled Base Chair – Full Back	810	865	880	1,005	1,175	1,175	1,590

TABLE OF CONTENTS



1501

Model#	1501, 1502, 1503	Model#	1501, 1502, 1503
Overall Depth (in)	26	COM (yards)	1.25
Overall Width	22	Carton (\$)	40
Seat Width	20	B-Weight (lbs)	21
Seat Depth	20	Cube (in ³)	11
Seat Height	19		
Back Height	32		
Arm Height	25		

Note: Width and depth are inside dimensions



Series	Model #	Type	A	B / COM	C	D	E	Leather Combo	All Leather
Guest 1500	Radius Edge Top-Slanted Back Legs								
	1501	Leg Chair	480	520	530	615	690	690	830
	1502	Leg Caster Chair	510	540	555	630	710	710	855
	1503	Sled Base Chair	510	540	555	630	710	710	855

TABLE OF CONTENTS



1601

Model#	1601	Model#	1601
Overall Depth (in)	26	COM (yards)	1.50
Overall Width	22	Carton (\$)	40
Seat Width	20	B-Weight (lbs)	21
Seat Depth	19	Cube (in ³)	11
Seat Height	19		
Back Height	32		
Arm Height	26		

Note: Width and depth are inside dimensions

Series	Model #	Type	A	B / COM	C	D	E	Leather Combo	All Leather
Guest 1600	Finger Joint Arms								
	1601	Sled Base Chair	540	590	615	735	850	850	990

**Add \$122 list for Dura Surface*

TABLE OF CONTENTS



1901

Model#	Model#
1901	1901
Overall Depth (in)	COM (yards)
27	1.50
Overall Width	Carton (\$)
24	40
Seat Width	B-Weight (lbs)
20	20
Seat Depth	Cube (in ³)
20	13
Seat Height	
19	
Back Height	
33	
Arm Height	
26	

Note: Width and depth are inside dimensions

Series	Model #	Type	A	B / COM	C	D	E	Leather Combo	All Leather
Guest 1900	Slanted Arms-Back Full-Back								
	1901	Leg Chair	460	515	555	625	765	805	945

**Add \$122 list for Dura Surface*

TABLE OF CONTENTS



2003

Model#	2001, 2002, 2003	Model#	2001, 2002, 2003
Overall Depth (in)	26	COM (yards)	1.25
Overall Width	24.5	Carton (\$)	40
Seat Width	20	B-Weight (lbs)	22
Seat Depth	19	Cube (in ³)	12
Seat Height	19		
Back Height	32		
Arm Height	25		

Note: Width and depth are inside dimensions



Series	Model #	Type	A	B / COM	C	D	E	Leather Combo	All Leather
Guest 2000	Flat Arms								
	2001	Leg Chair	455	505	520	590	665	665	805
	2002	Leg Caster Chair	485	530	540	620	690	690	830
	2003	Sled Base Chair	485	530	540	620	690	690	830

TABLE OF CONTENTS



2401

Model#	Model#
2401, 2402	2401, 2402
Overall Depth (in)	COM (yards)
26	1.75
Overall Width	Carton (\$)
22	40
Seat Width	B-Weight (lbs)
20	22
Seat Depth	Cube (in ³)
19	11
Seat Height	
19	
Back Height	
34	
Arm Height	
25	

Note: Width and depth are inside dimensions



Series	Model #	Type	A	B / COM	C	D	E	Leather Combo	All Leather
Guest 2400	Diamond Stitching Back Arm Wraps								
	2401	Leg Chair	705	765	800	930	1,050	1,050	1,185
	2402	Leg Caster Chair	740	800	835	955	1,085	1,085	1,225

TABLE OF CONTENTS



3501

Model#	3501, 3502, 3503	Model#	3501, 3502, 3503
Overall Depth (in)	26	COM (yards)	1.75
Overall Width	22	Carton (\$)	40
Seat Width	20	B-Weight (lbs)	24
Seat Depth	20	Cube (in ³)	11
Seat Height	25		
Back Height	32		
Arm Height	25		

Note: Width and depth are inside dimensions



Series	Model #	Type	A	B / COM	C	D	E	Leather Combo	All Leather
Guest 3500	Radius Arms-Legs Upholstered Arm Inserts								
	3501	Leg Chair	570	630	650	725	830	830	965
	3502	Leg Caster Chair	610	655	690	750	855	855	990
	3503	Sled Base Chair	610	655	690	750	855	855	990

TABLE OF CONTENTS



3701

Model#	3701, 3702	Model#	3701, 3702
Overall Depth (in)	27	COM (yards)	2.25
Overall Width	24	Carton (\$)	40
Seat Width	20	B-Weight (lbs)	20
Seat Depth	19	Cube (in ³)	14
Seat Height	19		
Back Height	36		
Arm Height	26		

Note: Width and depth are inside dimensions



Series	Model #	Type	A	B / COM	C	D	E	Leather Combo	All Leather
Guest 3700			Beveled Edge Arms-Legs Cross-Stitching High Resilient Foam Arm Pads						
	3701	Leg Chair	760	815	850	915	1,110	1,110	1,325
	3702	Leg Caster Chair	795	850	880	950	1,140	1,095	1,355

TABLE OF CONTENTS



5001

Model#	5001, 5002, 5003	Model#	5001, 5002, 5003
Overall Depth (in)	26	COM (yards)	1.50
Overall Width	22	Carton (\$)	40
Seat Width	20	B-Weight (lbs)	22
Seat Depth	19	Cube (in ³)	11
Seat Height	19		
Back Height	32		
Arm Height	26		

Note: Width and depth are inside dimensions



Series	Model #	Type	A	B / COM	C	D	E	Leather Combo	All Leather
Guest 5000	Radius Arms-Legs Slanted Arms Full Back								
	5001	Leg Chair	545	620	650	705	820	820	960
	5002	Leg Caster Chair	580	650	675	735	855	855	990
	5003	Sled Base Chair	580	650	675	735	855	855	990

TABLE OF CONTENTS



5501

Model#	5501, 5502	Model#	5501, 5502
Overall Depth (in)	26	COM (yards)	2.00
Overall Width	24	Carton (\$)	40
Seat Width	20	B-Weight (lbs)	22
Seat Depth	19	Cube (in ³)	11
Seat Height	19		
Back Height	32		
Arm Height	26		

Note: Width and depth are inside dimensions



Series	Model #	Type	A	B / COM	C	D	E	Leather Combo	All Leather
Guest 5500	Bentwood Arms								
	5501	Sled Base Chair	555	635	665	750	855	855	990
	5502	Sled Base Caster Chair	585	665	695	775	885	885	1,025

TABLE OF CONTENTS



5701

Model#	5701, 5702	Model#	5701, 5702
Overall Depth (in)	28	COM (yards)	2.00
Overall Width	24	Carton (\$)	40
Seat Width	20	B-Weight (lbs)	26
Seat Depth	19	Cube (in ³)	13
Seat Height	19		
Back Height	34		
Arm Height	26		

Note: Width and depth are inside dimensions



Series	Model #	Type	A	B / COM	C	D	E	Leather Combo	All Leather
Guest 5700	Bentwood Arms Vertical-Stitching Back								
	5701	Sled Base Chair	570	640	670	760	865	865	1,005
	5702	Sled Base Caster Chair	610	670	760	790	900	900	1,035

TABLE OF CONTENTS



6501

Model#	6501, 6502	Model#	6501, 6502
Overall Depth (in)	26	COM (yards)	2.00
Overall Width	24	Carton (\$)	40
Seat Width	20	B-Weight (lbs)	21
Seat Depth	19	Cube (in ³)	11
Seat Height	19		
Back Height	32		
Arm Height	26		

Note: Width and depth are inside dimensions



Series	Model #	Type	A	B / COM	C	D	E	Leather Combo	All Leather
Guest 6500		Bentwood Arms Vertical-Stitching Back-Seat							
	6501	Sled Base Chair	585	655	685	770	870	870	1,015
	6502	Sled Base Caster Chair	620	685	710	800	910	910	1,055

TABLE OF CONTENTS



7501

Model#	7501	Model#	7501
Overall Depth (in)	28	COM (yards)	2.00
Overall Width	23.5	Carton (\$)	40
Seat Width	20	B-Weight (lbs)	22
Seat Depth	19	Cube (in ³)	11
Seat Height	19		
Back Height	32		
Arm Height	26		

Note: Width and depth are inside dimensions

Series	Model #	Type	A	B / COM	C	D	E	Leather Combo	All Leather
Guest 7500	Lumbar Back High Resilient Foam								
	7501	Sled Base Chair	645	705	755	860	1,000	1,000	1,275

TABLE OF CONTENTS



7902

Model#	7901, 7902, 7903	Model#	7901, 7902, 7903
Overall Depth (in)	28	COM (yards)	3.00
Overall Width	23	Carton (\$)	44
Seat Width	20	B-Weight (lbs)	23
Seat Depth	20	Cube (in ³)	12
Seat Height	19		
Back Height	35		
Arm Height	26		

Note: Width and depth are inside dimensions



Series	Model #	Type	A	B / COM	C	D	E	Leather Combo	All Leather
Guest 7900	Arm Wraps Tufted Seat-Back								
	7901	Leg Chair	750	850	895	1,125	1,340	1,340	1,795
	7902	Leg Caster Chair	780	885	930	1,150	1,365	1,365	1,825
	7903	Sled Base Chair	780	885	930	1,150	1,365	1,365	1,825

TABLE OF CONTENTS



8010

Model#	Model#			
8010, 8020, 8030, 8040	8010	8020	8030	8040
Overall Depth (in)	COM (yards)			
24	1.50	2.00	1.50	2.00
Overall Width	Carton (\$)			
23	40	40	40	40
Seat Width	B-Weight (lbs)			
19	20	20	20	20
Seat Depth	Cube (in ³)			
19	11	11	11	11
Seat Height				
19				
Back Height				
35				
Arm Height				
25				

Note: Width and depth are inside dimensions





Series	Model #	Type	A	B / COM	C	D	E	Leather Combo	All Leather
Guest 8000-1									
	8010	Leg Chair	910	945	970	1,040	1,105	1,105	1,235
	8020	Leg Chair/Arm Insert	985	1,020	1,055	1,120	1,180	1,180	1,445
	8030	Leg Chair	970	1,010	1,040	1,105	1,175	1,175	1,305
	8040	Leg Chair/Arm Insert	1,055	1,085	1,120	1,180	1,250	1,250	1,515

TABLE OF CONTENTS



8050

Model#	Model#				
All Models	8050	8051	8060	8070	8080
Overall Depth (in)	COM (yards)				
24	1.50	2.00	2.00	1.50	2.00
Overall Width	Carton (\$)				
23	40	40	40	40	40
Seat Width	B-Weight (lbs)				
19	20	20	20	20	20
Seat Depth	Cube (in ³)				
19	11	11	11	11	11
Seat Height					
19					
Back Height					
35					
Arm Height					
25					

Note: Width and depth are inside dimensions





Series	Model #	Type	A	B / COM	C	D	E	Leather Combo	All Leather
Guest 8000-2									
	8050	Leg Chair	910	945	970	1,040	1,105	1,105	1,235
	8051	Leg Chair	910	945	970	1,040	1,105	1,105	1,235
	8060	Leg Chair/Arm Insert	985	1,020	1,055	1,120	1,180	1,180	1,445
	8070	Leg Chair	970	1,010	1,040	1,105	1,175	1,175	1,305
	8080	Leg Chair/Arm Insert	1,055	1,085	1,120	1,180	1,250	1,250	1,515

TABLE OF CONTENTS



8201

Model#	8001, 8101, 8201	Model#	8001, 8101, 8201
Overall Depth (in)	27	COM (yards)	2.00
Overall Width	23	Carton (\$)	40
Seat Width	20	B-Weight (lbs)	24
Seat Depth	19	Cube (in ³)	13
Seat Height	19		
Back Height	35		
Arm Height	26		

Note: Width and depth are inside dimensions



Series	Model #	Type	A	B / COM	C	D	E	Leather Combo	All Leather
Guest 8000-3									
	8001	Leg Chair	910	955	980	1,090	1,225	1,245	1,385
	8101	Leg Chair	975	1,025	1,055	1,165	1,290	1,315	1,450
	8201	Leg Chair	1,025	1,075	1,095	1,215	1,340	1,360	1,505

TABLE OF CONTENTS



8231

Model#			Model#		
8231	8301	8401	8231	8301	8401
Overall Depth (in)			COM (yards)		
24	27	27	2.50	2.50	3.00
Overall Width			Carton (\$)		
23	23	23	40	40	40
Seat Width			B-Weight (lbs)		
19	20	20	26	26	38
Seat Depth			Cube (in ³)		
19	19	19	13	13	13
Seat Height					
19	19	19			
Back Height					
35	35	35			
Arm Height					
25	26	26			

Note: Width and depth are inside dimensions



Series	Model #	Type	A	B / COM	C	D	E	Leather Combo	All Leather
Guest 8000-4									
	8231	Leg Chair	1,085	1,125	1,170	1,200	1,235	1,235	1,300
	8301	Leg Chair	975	1,025	1,055	1,165	1,290	1,315	1,450
	8401	Leg Chair	1,025	1,075	1,095	1,215	1,340	1,360	1,505

TABLE OF CONTENTS



8601

Model#	8601	Model#	8601
Overall Depth (in)	27	COM (yards)	2.00
Overall Width	23	Carton (\$)	40
Seat Width	20	B-Weight (lbs)	23
Seat Depth	19	Cube (in ³)	11
Seat Height	19		
Back Height	36		
Arm Height	26		

Note: Width and depth are inside dimensions



Series	Model #	Type	A	B / COM	C	D	E	Leather Combo	All Leather
Guest 8600	Curved Arms High Resilient Foam 3/4th Back								
	8601	Leg Chair – ¾ Back	920	970	1,030	1,105	1,190	1,190	1,335
	8602	Leg Caster Chair – ¾ Back	960	1,010	1,070	1,140	1,225	1,225	1,370

TABLE OF CONTENTS



8611

Model#	8611	Model#	8611
Overall Depth (in)	27	COM (yards)	2.00
Overall Width	23	Carton (\$)	40
Seat Width	20	B-Weight (lbs)	23
Seat Depth	19	Cube (in ³)	11
Seat Height	19		
Back Height	36		
Arm Height	26		

Note: Width and depth are inside dimensions



Series	Model #	Type	A	B / COM	C	D	E	Leather Combo	All Leather
Guest 8610	Curved Arms High Resilient Foam Full-Back								
	8611	Leg Chair – Full Back	920	970	1,030	1,105	1,190	1,190	1,335
	8612	Leg Caster Chair – Full Back	960	1,010	1,070	1,140	1,225	1,225	1,370





TABLE OF CONTENTS



8721

Model#	8701, 8711, 8721, 8731	Model#	8701, 8711, 8721, 8731
Overall Depth (in)	24	COM (yards)	1.50
Overall Width	23	Carton (\$)	40
Seat Width	20	B-Weight (lbs)	20
Seat Depth	20	Cube (in ³)	11
Seat Height	19		
Back Height	34		
Arm Height	27		

Note: Width and depth are inside dimensions

Series	Model #	Type	A	B / COM	C	D	E	Leather Combo	All Leather
Guest 8700	Curved Arms								
	8701	Leg Chair	885	910	955	1,025	1,235	1,200	1,330
	8711	Leg Chair	810	830	875	950	1,150	1,125	1,250
	8721	Leg Chair	810	830	875	950	1,150	1,125	1,250
	8731	Leg Chair	885	910	955	1,025	1,235	1,200	1,330

*Add \$122 list for Dura Surface

TABLE OF CONTENTS



8801

Model#	8801	8810
Overall Depth (in)	1.00	1.50
Overall Width	Carton (\$)	
	45	45
Seat Width	B-Weight (lbs)	
	21	21
Seat Depth	Cube (in ³)	
	11	11
Seat Height		
Back Height		
Arm Height		

Note: Width and depth are inside dimensions



Series	Model #	Type	A	B / COM	C	D	E	Leather Combo	All Leather
Guest 8800	Horizontal Wood Slat or Upholstered Back								
	8801	Leg Chair Wood Slat	945	980	1,010	1,070	1,140	1,140	1,225
	8810	Leg Chair Open Half Back	945	980	1,010	1,070	1,140	1,140	1,225



TABLE OF CONTENTS



9001

Model#	Model#	
9001, 9010	9001	9010
Overall Depth (in)	COM (yards)	
26	1.25	2.00
Overall Width	Carton (\$)	
22	40	40
Seat Width	B-Weight (lbs)	
20	23	23
Seat Depth	Cube (in ³)	
19	13	13
Seat Height		
19		
Back Height		
32		
Arm Height		
26		

Note: Width and depth are inside dimensions

Series	Model #	Type	A	B / COM	C	D	E	Leather Combo	All Leather
Guest 9000									
	9001	Leg Chair	580	640	730	850	975	975	1,065
	9010	Leg Chair	665	730	810	940	1,065	1,065	1,145

*Note: Pricing shows alder wood in, A-Sienna, A-Espresso, A-Mahogany, and A-Light Cherry
Add \$122 list for Walnut, Cherry, Oak, or Maple Wood*

TABLE OF CONTENTS



9011

Model#	9011, 9015	Model#	9011,9015
Overall Depth (in)	26	COM (yards)	1.00
Overall Width	24	Carton (\$)	40
Seat Width	20	B-Weight (lbs)	23
Seat Depth	20	Cube (in ³)	13
Seat Height	19		
Back Height	35		
Arm Height	26		

Note: Width and depth are inside dimensions



Series	Model #	Type	A	B / COM	C	D	E	Leather Combo	All Leather
Guest 9011/9015 Vertical or Horizontal Slat Back High Resilient Foam									
	9011	Vertical Slats Leg Chair	955	990	1,055	1,115	1,235	1,235	1,235
	9015	Horizontal Slats Leg Chair	955	990	1,055	1,115	1,235	1,235	1,235



TABLE OF CONTENTS



9021

Model#	9021, 9022	Model#	9021, 9022
Overall Depth (in)	27	COM (yards)	1.75
Overall Width	23	Carton (\$)	40
Seat Width	20	B-Weight (lbs)	22
Seat Depth	19	Cube (in ³)	11
Seat Height	19		
Back Height	32		
Arm Height	27		

Note: Width and depth are inside dimensions

Series	Model #	Type	A	B / COM	C	D	E	Leather Combo	All Leather
Guest 9020	V-Stitching Curved Arms								
	9021	Leg Chair	560	610	630	740	850	850	1,010
	9021-LKDB	Leg (RTA)	620	660	685	795	905	905	1,065
	9022	Leg Caster	590	640	655	770	880	880	1,040
	9022-CKDB	Leg Caster (RTA)	645	695	720	830	940	940	1,095

*Note: Pricing shows alder wood in, A-Sienna, A-Espresso, A-Mahogany, and A-Light Cherry
Add \$122 list for Walnut, Cherry, Oak, or Maple Wood
Add \$122 list for Dura Surface



TABLE OF CONTENTS



9031

Model#	9031, 9032	Model#	9031, 9032
Overall Depth (in)	25	COM (yards)	1.75
Overall Width	23	Carton (\$)	40
Seat Width	20	B-Weight (lbs)	22
Seat Depth	19	Cube (in ³)	12
Seat Height	19		
Back Height	32		
Arm Height	26		

Note: Width and depth are inside dimensions

Series	Model #	Type	A	B / COM	C	D	E	Leather Combo	All Leather
Guest 9030	Arch Arms Straight legs								
	9031	Leg Chair	560	610	630	740	850	850	1,010
	9032	Leg Caster Chair	590	640	655	770	880	880	1,040

**Add \$122 list for Dura Surface*

TABLE OF CONTENTS



9301

Model#	9301, 9302	Model#	9301, 9302
Overall Depth (in)	30	COM (yards)	2.25
Overall Width	24	Carton (\$)	40
Seat Width	20	B-Weight (lbs)	23
Seat Depth	20	Cube (in ³)	15
Seat Height	19		
Back Height	36		
Arm Height	26		

Note: Width and depth are inside dimensions



Series	Model #	Type	A	B / COM	C	D	E	Leather Combo	All Leather
Guest 9300	Lumbar Support Traditional Arms High Resilient Foam								
	9301	Leg Chair	925	975	1,010	1,075	1,275	1,260	1,525
	9302	Leg Caster Chair	960	1,010	1,040	1,110	1,300	1,295	1,555

TABLE OF CONTENTS



9502

Model#	9501, 9502	Model#	9501, 9502
Overall Depth (in)	24	COM (yards)	2.00
Overall Width	22.5	Carton (\$)	40
Seat Width	20	B-Weight (lbs)	23
Seat Depth	19	Cube (in ³)	11
Seat Height	19		
Back Height	33		
Arm Height	26		

Note: Width and depth are inside dimensions



Series	Model #	Type	A	B / COM	C	D	E	Leather Combo	All Leather
Guest 9500	Curved Arms Upholstered Arm Inserts								
	9501	Leg Chair	750	810	845	960	1,105	1,105	1,370
	9502	Leg Caster Chair	775	845	865	990	1,125	1,125	1,400

TABLE OF CONTENTS



9521

Model#	9521, 9522	Model#	9521, 9522
Overall Depth (in)	26	COM (yards)	1.75
Overall Width	22.5	Carton (\$)	36
Seat Width	20	B-Weight (lbs)	23
Seat Depth	19	Cube (in ³)	11
Seat Height	19		
Back Height	33		
Arm Height	26		

Note: Width and depth are inside dimensions



Series	Model #	Type	A	B / COM	C	D	E	Leather Combo	All Leather
Guest 9520	Traditional Radius Edge Arms-Legs								
	9521	Leg Chair	750	810	845	960	1,105	1,105	1,240
	9522	Leg Caster Chair	775	845	865	990	1,125	1,125	1,260

TABLE OF CONTENTS



9601

Model#	9603	Model#	9603
Overall Depth (in)	28	COM (yards)	2.00
Overall Width	24	Carton (\$)	36
Seat Width	20	B-Weight (lbs)	25
Seat Depth	19	Cube (in ³)	13
Seat Height	19		
Back Height	34		
Arm Height	26		

Note: Width and depth are inside dimensions

Series	Model #	Type	A	B / COM	C	D	E	Leather Combo	All Leather
Guest 9600	Traditional Curved Arms Arm Pads High Resilient Foam								
	9601	Sled Base Chair	775	830	850	925	1,090	1,090	1,370

TABLE OF CONTENTS



9703

Model#	9703	Model#	9703
Overall Depth (in)	30	COM (yards)	2.25
Overall Width	24	Carton (\$)	40
Seat Width	20	B-Weight (lbs)	30
Seat Depth	20	Cube (in ³)	15
Seat Height	19		
Back Height	36		
Arm Height	26.5		

Note: Width and depth are inside dimensions

Series	Model #	Type	A	B / COM	C	D	E	Leather Combo	All Leather
Guest 9700	Traditional Curved Arms Arm Pads High Resilient Foam								
	9703	Sled Base Chair	855	910	945	1,010	1,200	1,160	1,420



TABLE OF CONTENTS



FCF1

Model#	Model#
FCF1, FCF2, FCF3	FCF1, FCF2, FCF3
Overall Depth (in)	COM (yards)
25	2.00
Overall Width	Carton (\$)
22.5	40
Seat Width	B-Weight (lbs)
20	22
Seat Depth	Cube (in ³)
19	11
Seat Height	
19	
Back Height	
34	
Arm Height	
26	

Note: Width and depth are inside dimensions

Series	Model #	Type	A	B / COM	C	D	E	Leather Combo	All Leather
Guest FCF1	High Resilient Foam								
	FCF1	Leg Chair	670	725	745	860	985	1,030	1,170
	FCF2	Leg Caster Chair	700	750	770	880	1,010	1,055	1,195
	FCF3	Sled Base Chair	700	750	770	880	1,010	1,055	1,195

**Add \$122 list for Dura Surface*



TABLE OF CONTENTS



FCF11

Model#	Model#
FCF11, FCF12, FCF13	FCF11, FCF12, FCF13
Overall Depth (in)	COM (yards)
25	2.00
Overall Width	Carton (\$)
25	40
Seat Width	B-Weight (lbs)
20	22
Seat Depth	Cube (in ³)
19	11
Seat Height	
19	
Back Height	
34	
Arm Height	
26	

Note: Width and depth are inside dimensions

Series	Model #	Type	A	B / COM	C	D	E	Leather Combo	All Leather
Guest FCF11	High Resilient Foam								
	FCF11	Leg Chair	695	745	770	880	1,010	1,055	1,195
	FCF12	Leg Caster Chair	725	770	800	905	1,035	1,075	1,220
	FCF13	Sled Base Chair	725	770	800	905	1,035	1,075	1,220

**Add \$122 list for Dura Surface*

TABLE OF CONTENTS

LOUNGE SEATING

[Back to main Tables of Contents](#)

Click image to jump page

 #400	 #550	 #600	
<i>pg. 100</i>	<i>pg. 101</i>	<i>pg. 102</i>	
 #650	 #770	 #850	
<i>pg. 103</i>	<i>pg. 104</i>	<i>pg. 105</i>	
 #890	 #930	 #950	 #990
<i>pg. 106</i>	<i>pg. 107</i>	<i>pg. 108</i>	<i>pg. 109</i>

TABLE OF CONTENTS



401

Model#			Model#		
401	402	403	401	402	403
Overall Depth (in)			COM (yards)		
31	31	31	7.00	10.00	13.00
Overall Width			Carton (\$)		
31	52	73	112	159	202
Seat Width			B-Weight (lbs)		
22	44	66	70	100	130
Seat Depth			Cube (in ³)		
20	20	20	19	33	47
Seat Height					
18	18	18			
Back Height					
32	32	32			
Arm Height					
25	25	25			

Note: Width and depth are inside dimensions



Series	Model #	Type	A	B / COM	C	D	E	Leather Combo	All Leather
Lounge 400 Fixed Seat Cushions Brushed Satin Legs									
	401	Single Seat Chair	1,750	1,865	2,010	2,280	2,650	2,695	3,475
	402	Double Love Seat	2,235	2,355	2,565	2,965	3,475	3,595	5,145
	403	3-Seater Full Sofa	2,770	2,900	3,125	3,500	3,815	4,120	6,015



TABLE OF CONTENTS



551

Model#			Model#		
551	552	553	551	552	553
Overall Depth (in)			COM (yards)		
28	28	28	5.00	7.00	9.00
Overall Width			Carton (\$)		
29	53	77	112	159	202
Seat Width			B-Weight (lbs)		
24	48	72	51	60	72
Seat Depth			Cube (in ³)		
20	20	20	15	27	39
Seat Height					
19	19	19			
Back Height					
31	31	31			
Arm Height					
26	26	26			

Note: Width and depth are inside dimensions

Series	Model #	Type	A	B / COM	C	D	E	Leather Combo	All Leather
Lounge 550	Exposed Arms Removable Seat & Back Cushions								
	551	Single Seat Chair	1,000	1,185	1,255	1,670	1,955	1,955	2,505
	552	Double Love Seat	1,450	1,745	1,860	2,505	2,925	2,925	3,760
	553	3-Seater Full Sofa	2,090	2,530	2,715	3,630	4,165	4,165	5,275

**Add \$122 list for Dura Surface*

TABLE OF CONTENTS



601

Model#			Model#		
601	602	603	601	602	603
Overall Depth (in)			COM (yards)		
29	29	29	5.00	7.00	9.00
Overall Width			Carton (\$)		
32	56	80	112	159	202
Seat Width			B-Weight (lbs)		
24	48	72	51	60	72
Seat Depth			Cube (in ³)		
20	20	20	16	28	40
Seat Height					
19	19	19			
Back Height					
31	31	31			
Arm Height					
26	26	26			

Note: Width and depth are inside dimensions



Series	Model #	Type	A	B / COM	C	D	E	Leather Combo	All Leather
Lounge 600	Removable Seat & Back Cushions								
	601	Single Seat Chair	1,000	1,185	1,255	1,670	1,950	1,950	2,505
	602	Double Love Seat	1,450	1,745	1,860	2,505	2,925	2,925	3,760
	603	3-Seater Full Sofa	2,090	2,530	2,715	3,630	4,165	4,165	5,275

TABLE OF CONTENTS



651

Model#			Model#		
651	652	653	651	652	653
Overall Depth (in)			COM (yards)		
29	29	29	5.00	7.00	9.00
Overall Width			Carton (\$)		
32	56	80	112	159	202
Seat Width			B-Weight (lbs)		
24	48	72	51	60	72
Seat Depth			Cube (in ³)		
20	20	20	16	28	40
Seat Height					
19	19	19			
Back Height					
31	31	31			
Arm Height					
26	26	26			

Note: Width and depth are inside dimensions



Series	Model #	Type	A	B / COM	C	D	E	Leather Combo	All Leather
Lounge 650	Removable Seat & Back Cushions								
	651	Single Seat Chair	1,000	1,185	1,255	1,670	1,950	1,950	2,505
	652	Double Love Seat	1,450	1,745	1,860	2,505	2,925	2,925	3,760
	653	3-Seater Full Sofa	2,090	2,530	2,715	3,630	4,165	4,165	5,275

TABLE OF CONTENTS



771

Model#					Model#				
771	772	773	772-3A	773-4A	771	772	773	772-3A	773-4A
Overall Depth (in)					COM (yards)				
33	33	33	33	33	7.00	10.00	13.00	11.50	16.00
Overall Width					Carton (\$)				
30	52	74	56	84	112	159	202	179	225
Seat Width					B-Weight (lbs)				
22	44	66	22/ea.	22/ea.	86	122	158	145	204
Seat Depth					Cube (in ³)				
20	20	20	20	20	19	33	47	36	53
Seat Height									
18	18	18	18	18					
Back Height									
33	33	33	33	33					
Arm Height									
25	25	25	25	25					

Note: Width and depth are inside dimensions





Series	Model #	Type	A	B / COM	C	D	E	Leather Combo	All Leather
Lounge 770	Fixed Seat & Back Cushions High Resilient Foam								
	771	Single Seat Chair	1,750	1,865	2,010	2,280	2,650	2,695	3,670
	772	Double Love Seat	2,240	2,355	2,560	2,965	3,475	3,595	4,845
	773	3-Seater Full Sofa	2,770	2,900	3,125	3,500	3,815	4,115	5,650
	772-3A	2-Seater w/Mid Arm	2,735	2,850	3,060	3,455	3,970	4,090	5,340
	773-4A	3-Seater w/Mid Arm	3,760	3,885	4,110	4,490	4,735	5,110	6,635



TABLE OF CONTENTS



851

Model#			Model#		
851	852	853	851	852	853
Overall Depth (in)			COM (yards)		
28	28	28	4.00	6.00	8.00
Overall Width			Carton (\$)		
30	52	74	112	159	202
Seat Width			B-Weight (lbs)		
22	44	66	60	80	113
Seat Depth			Cube (in ³)		
20	20	20	15	26	37
Seat Height					
19	19	19			
Back Height					
31	31	31			
Arm Height					
26	26	26			

Note: Width and depth are inside dimensions

Series	Model #	Type	A	B / COM	C	D	E	Leather Combo	All Leather
Lounge 850	4" Wide Arms Fixed Seat and Back Cushions								
	851	Single Seat Chair	1,305	1,480	1,555	1,945	2,180	2,180	2,450
	852	Double Love Seat	1,745	2,050	2,140	2,775	3,135	3,135	3,555
	853	3-Seater Full Sofa	2,400	2,835	2,995	3,895	4,410	4,410	4,965

*Add \$122 list for Dura Surface

TABLE OF CONTENTS



891

Model#			Model#		
891	892	893	891	892	893
Overall Depth (in)			COM (yards)		
31	31	31	4.00	7.00	10.00
Overall Width			Carton (\$)		
30	54	78	112	159	202
Seat Width			B-Weight (lbs)		
24	48	72	55	85	115
Seat Depth			Cube (in ³)		
21	21	21	18	33	48
Seat Height					
19	19	19			
Back Height					
34	34	34			
Arm Height					
20	20	20			

Note: Width and depth are inside dimensions



Series	Model #	Type	A	B / COM	C	D	E	Leather Combo	All Leather
Lounge 890	Tapered Legs								
	891	Single Seat Chair	1,455	1,630	1,780	2,040	2,340	2,340	2,910
	892	Double Love Seat	1,965	2,130	2,295	2,545	2,850	2,850	3,420
	893	3-Seater Full Sofa	2,475	2,645	2,800	3,055	3,355	3,355	3,930

TABLE OF CONTENTS



931

Model#			Model#		
931	932	933	931	932	933
Overall Depth (in)			COM (yards)		
31	31	31	5.00	7.00	9.00
Overall Width			Carton (\$)		
31	52	74	112	159	202
Seat Width			B-Weight (lbs)		
22	44	66	55	86	112
Seat Depth			Cube (in ³)		
20	20	20	19	31	43
Seat Height					
18	18	18			
Back Height					
33	33	33			
Arm Height					
26	26	26			

Note: Width and depth are inside dimensions



Series	Model #	Type	A	B / COM	C	D	E	Leather Combo	All Leather
Lounge 930	Tapered Wood Legs Fixed Seat & Back Cushions								
	931	Single Seat Chair	1,685	1,785	1,955	2,220	2,695	2,695	3,475
	932	Double Love Seat	2,165	2,285	2,510	2,880	3,460	3,460	5,060
	933	3-Seater Full Sofa	2,705	2,825	3,050	3,425	4,045	4,045	5,935

TABLE OF CONTENTS



951

Model#			Model#		
951	952	953	951	952	953
Overall Depth (in)			COM (yards)		
30	30	30	5.00	7.00	9.00
Overall Width			Carton (\$)		
33	54	75	112	159	202
Seat Width			B-Weight (lbs)		
21	42	63	60	82	103
Seat Depth			Cube (in ³)		
20	20	20	19	31	43
Seat Height					
19	19	19			
Back Height					
33	33	33			
Arm Height					
26	26	26			

Note: Width and depth are inside dimensions



Series	Model #	Type	A	B / COM	C	D	E	Leather Combo	All Leather
Lounge 950	Curved Arms and Back Fixed Back and Removable Seat Cushions High Resilient Foam								
	951	Single Seat Chair	1,545	1,645	1,805	2,080	2,450	2,550	3,390
	952	Double Love Seat	2,015	2,140	2,365	2,745	3,240	3,375	4,490
	953	3-Seater Full Sofa	2,550	2,670	2,900	3,280	3,595	3,895	5,285

TABLE OF CONTENTS



Model#				Model#			
991-NA	991-LA	991-RA	991-A	991-NA	991-RA	991-LA	991-A
Overall Depth (in)				COM (yards)			
30	30	30	30	3.00	4.50	4.50	6.00
Overall Width				Carton (\$)			
24	28	28	32	109	109	109	109
Seat Width				B-Weight (lbs)			
24	24	24	24	42	52	52	62
Seat Depth				Cube (in ³)			
21	21	21	21	14	16	16	18
Seat Height							
18	18	18	18				
Back Height							
32	32	32	32				
Arm Height							
-	26	26	26				

SWIVEL TABLET
¾" thick laminate 14" round,
oval, or kidney in any FCF
standard finish

Add \$265 list

*Note: Width and
depth are inside
dimensions*

LAGUNA 991-A





Series	Model #	Type	A	B / COM	C	D	E	Leather Combo	All Leather
Lounge 990	Laguna One Seater Modular High Resilient Foam								
	991-NA	No Arms	1,145	1,250	1,380	1,615	1,870	1,785	2,385
	991-RA	Right Arm	1,405	1,545	1,700	1,965	2,245	2,130	2,850
	991-LA	Left Arm	1,405	1,545	1,700	1,965	2,245	2,130	2,850
	991-A	Arms	1,670	1,840	2,020	2,315	2,630	2,490	3,320

TABLE OF CONTENTS

Model#		
991-30	991-60	991-90
Overall Depth (in)		
30	30	30
Overall Width		
20FCTC	20FCTC	20FCTC
36BCTC	48BCTC	58BCTC
Seat Width		
20F	20F	20F
32B	44B	46B
Seat Depth		
21	21	21
Seat Height		
18	18	18
Back Height		
32	32	32
Arm Height		
-	-	-

Model#		
991-30	991-60	991-90
COM (yards)		
3.50	4.00	5.00
Carton (\$)		
129	155	181
B-Weight (lbs)		
44	60	64
Cube (in ³)		
20	25	27

Note: Width and depth are inside dimensions

GANG CONNECTOR

Connects 2 units
Add \$56 list

POWER/DATA

3 ½" Black Round port installed
Add \$278 list

TAPERED WOOD LEGS

Add \$85 list

CA-133

991-30: add \$480 list
991-60: add \$594 list
991-90: add \$710 list





Series	Model #	Type	A	B / COM	C	D	E	Leather Combo	All Leather
Lounge 990	Laguna Curved Modular								
	991-30	30 Degree	1,455	1,695	1,830	2,065	2,450	2,325	2,955
	991-60	60 Degree	2,025	2,210	2,450	2,815	3,165	3,020	4,165
	991-90	90 Degree	2,200	2,390	2,645	3,015	3,385	3,235	4,410

TABLE OF CONTENTS



Model#				Model#			
LI24	LI28	LC24	LC28	LI24	LI28	LC24	LC28
Overall Depth (in)				COM (yards)			
24	28	24	28	.75	1.00	1.00	1.25
Overall Width				Carton (\$)			
24	24	48	48	92	92	107	107
Overall Height				B-Weight (lbs)			
16	16	16	16	42	50	66	74
				Cube (in ³)			
				6	7	11	13

Note: Width and depth are inside dimensions

Series	Model #	Type	A	B / COM	C	D	E	All Leather	All HPL
Lounge 990	Inner and Coffee Table – Upholstered base; TFM Top w/Wood Beveled Edge								
	LI24	Inner	655	685	730	795	830	900	900
	LI28	Inner	730	740	795	865	880	970	970
	LC24	Coffee	915	955	1,010	1,105	1,185	1,295	1,275
	LC28	Coffee	985	1,025	1,080	1,175	1,255	1,365	1,345

POWER/DATA
3" Black Round Port
Add \$278 list

CA-133
Inner: add \$140 list
Coffee: add \$194 list

TABLE OF CONTENTS

Model#	
LC3024	LC3028
Overall Depth (in)	
24	28
Overall Width	
20FCTC	20FCTC
32BCTC	34BCTC
Overall Height	
16	16

Model#	
LC3024	LC3028
Carton (\$)	
107	107
B-Weight (lbs)	
40	50
Cube (in ³)	
8	9

Model#	
LC6024	LC6028
Overall Depth (in)	
24	28
Overall Width	
20FCTC	20FCTC
44BCTC	46BCTC
Overall Height	
16	16



Model#	
LC6024	LC6028
Carton (\$)	
107	120
B-Weight (lbs)	
58	65
Cube (in ³)	
10	11



*Available in all-upholstered.
Same price as below.

Model#	
LC9024	LC9028
Overall Depth (in)	
24	28
Overall Width	
20FCTC	20FCTC
54BCTC	56BCTC
Overall Height	
16	16

Model#	
LC9024	LC9028
Carton (\$)	
142	155
B-Weight (lbs)	
62	69
Cube (in ³)	
12	15

Series	Model #	Type	A	B / COM	C	D	E	All Leather	All HPL
Lounge 990	Curved Table – Upholstered base; TFM Top w/Wood Beveled Edge								
	LC3024	30 Degree	1,180	1,225	1,275	1,350	1,410	1,445	1,110
	LC3028	30 Degree	1,285	1,330	1,380	1,455	1,515	1,580	1,180
	LC6024	60 Degree	1,510	1,570	1,640	1,715	1,820	1,905	1,305
	LC6028	60 Degree	1,580	1,640	1,710	1,785	1,890	1,980	1,510
	LC9024	90 Degree	1,740	1,795	1,865	1,945	2,050	2,130	1,665
	LC9028	90 Degree	1,810	1,880	1,935	2,010	2,115	2,205	1,740

POWER/DATA
3" Black Round Port
Add \$278 list

CA-133
30 Degree: add \$140 list
60 Degree: add \$194 list
90 Degree: add \$255 list





TABLE OF CONTENTS



Model#				
LR24	LR30	LR36	LR42	LR48
Overall Depth (in)				
24	30	36	42	48
Overall Width				
24	30	36	42	48
Overall Height				
16	16	16	16	16

Note: Width and depth are inside dimensions

Model#				
LR24	LR30	LR36	LR42	LR48
COM (yards)				
1.00	1.00	1.25	1.25	1.25
Carton (\$)				
82	112	134	171	198
B-Weight (lbs)				
42	54	66	80	94
Cube (in ³)				
6	9	12	17	22

Series	Model #	Type	A	B / COM	C	D	E	All Leather	All HPL
Lounge 990	Round Table – Upholstered base; TFM Top w/Wood Beveled Edge								
	LR24	24"	1,145	1,260	1,240	1,305	1,390	1,455	1,085
	LR30	30"	1,290	1,330	1,385	1,450	1,535	1,600	1,295
	LR36	36"	1,435	1,470	1,530	1,600	1,675	1,745	1,510
	LR42	42"	1,570	1,615	1,665	1,740	1,810	1,885	1,725
	LR48	48"	1,715	1,755	1,805	1,875	1,960	2,020	1,935

POWER/DATA
3" Black Round Port
Add \$278 list

CA-133
24": add \$140 list
30": add \$170 list
36": add \$194 list
42": add \$225 list
48": add \$267 list

TABLE OF CONTENTS



Model#				Model#			
LI24	LI28	LC24	LC28	LI24	LI28	LC24	LC28
Overall Depth (in)				Carton (\$)			
24	28	24	28	92	92	107	107
Overall Width				B-Weight (lbs)			
24	24	48	48	42	50	66	74
Overall Height				Cube (in ³)			
16	16	16	16	6	7	11	13

Note: Width and depth are inside dimensions

Series	Model #	Type	All HPL	All Veneer
Lounge 990	Inner and Coffee Table – All HPL & Veneer, self edge, no seams, no wood edge			
	LI24	Inner	755	1,075
	LI28	Inner	830	1,140
	LC24	Coffee	1,080	1,630
	LC28	Coffee	1,150	1,695

TABLE OF CONTENTS





Model#	
LC3024	LC3028
Overall Depth (in)	
24	28
Overall Width	
20FCTC	20FCTC
32BCTC	34BCTC
Overall Height	
16	16

Model#	
LC3024	LC3028
Carton (\$)	
107	107
B-Weight (lbs)	
40	50
Cube (in ³)	
8	9

Model#	
LC6024	LC6028
Overall Depth (in)	
24	28
Overall Width	
20FCTC	20FCTC
44BCTC	46BCTC
Overall Height	
16	16

Model#	
LC6024	LC6028
Carton (\$)	
107	155
B-Weight (lbs)	
58	65
Cube (in ³)	
10	11

Series	Model #	Type	All HPL	All Veneer
Lounge 990	Curved Table – All HPL & Veneer, self edge, no seams, no wood edge			
	LC3024	30 Degree	970	1,450
	LC3028	30 Degree	1,040	1,525
	LC6024	60 Degree	1,210	1,590
	LC6028	60 Degree	1,280	1,665
	LC9024	90 Degree	1,440	1,830
	LC9028	90 Degree	1,510	1,900

Model#	
LC9024	LC9028
Overall Depth (in)	
24	28
Overall Width	
20FCTC	20FCTC
54BCTC	56BCTC
Overall Height	
16	16

Model#	
LC9024	LC9028
Carton (\$)	
142	155
B-Weight (lbs)	
62	69
Cube (in ³)	
12	15

Note: Width and depth are inside dimensions

TABLE OF CONTENTS



Model#				
LR24	LR30	LR36	LR42	LR48
Overall Depth (in)				
24	30	36	42	48
Overall Width				
24	30	36	42	48
Overall Height				
16	16	16	16	16

Model#				
LR24	LR30	LR36	LR42	LR48
Carton (\$)				
82	112	134	171	198
B-Weight (lbs)				
42	54	66	80	94
Cube (in ³)				
6	9	12	17	22

Note: Width and depth are inside dimensions





Series	Model #	Type	All HPL	All Veneer
Lounge 990	Round Table – All HPL & Veneer, self edge, no seams, no wood edge			
	LR24	24"	855	1,195
	LR30	30"	990	1,300
	LR36	36"	1,135	1,510
	LR42"	42"	1,280	1,725
	LR48	48"	1,425	1,935

TABLE OF CONTENTS

RECEPTION SEATING

[Back to main Tables of Contents](#)

Click image to jump page

 <p>#980</p>	 <p>#1000</p>	 <p>#1000G</p>	 <p>#1500G</p>
<p>pg. 118</p>	<p>pg. 119</p>	<p>pg. 120</p>	<p>pg. 121</p>
 <p>#2400</p>	 <p>#5500G</p>	 <p>#6500G</p>	 <p>#8700</p>
<p>pg. 122</p>	<p>pg. 123</p>	<p>pg. 124</p>	<p>pg. 125</p>
 <p>#9500G</p>	 <p>#FCF1-G</p>	 <p>#FCF7/8</p>	 <p>#FCF11-G</p>
<p>pg. 126</p>	<p>pg. 127</p>	<p>pg. 128</p>	<p>pg. 129</p>

TABLE OF CONTENTS



983

Model#				Model#			
981	982	983	984	981	982	983	984
Overall Depth (in)				COM (yards)			
20	20	20	20	1.00	1.50	2.00	2.50
Overall Width				Carton (\$)			
20	40	60	80	40	82	122	160
Seat Width				B-Weight (lbs)			
20	40	60	80	18	32	46	60
Seat Depth				Cube (in ³)			
20	20	20	20	5	10	14	19
Seat Height							
19	19	19	19				
Back Height							
-	-	-	-				
Arm Height							
-	-	-	-				

Note: Width and depth are inside dimensions



Series	Model #	Type	A	B / COM	C	D	E	Leather Combo	All Leather
Reception 980	High Resilient Foam								
	981	Single Seat Bench	695	725	775	810	885		885
	982	Double Seat Bench	875	910	1,000	1,035	1,150		1,150
	983	3 Seat Bench	1,235	1,280	1,400	1,455	1,610		1,610
	984	4 Seat Bench	1,450	1,500	1,650	1,720	1,910		1,910

TABLE OF CONTENTS



1000-4

Model#			Model#		
1000-2	1000-3	1000-4	1000-2	1000-3	1000-4
Overall Depth (in)			COM (yards)		
20	20	20	1.50	2.25	3.00
Overall Width			Carton (\$)		
42	62	82	82	122	160
Seat Width			B-Weight (lbs)		
40	60	80	28	38	46
Seat Depth			Cube (in ³)		
20	20	20	16	24	32
Seat Height					
19	19	19			
Back Height					
-	-	-			
Arm Height					
-	-	-			

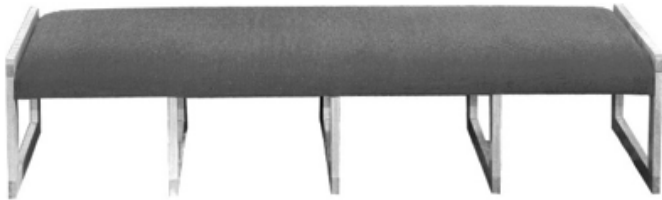
Note: Width and depth are inside dimensions

Series	Model #	Type	A	B / COM	C	D	E	Leather Combo	All Leather
Reception 1000									
	1000-2	2-Seater Bench	710	770	840	950	1,010	1,010	1,010
	1000-3	3-Seater Bench	1,010	1,110	1,175	1,280	1,385	1,385	1,385
	1000-4	4-Seater Bench	1,290	1,460	1,515	1,690	1,860	1,860	1,860

TABLE OF CONTENTS



1000-4G

Model#			Model#		
1000-2G	1000-3G	1000-4G	1000-2G	1000-3G	1000-4G
Overall Depth (in)			COM (yards)		
26	26	26	3.00	4.00	5.00
Overall Width			Carton (\$)		
43	64	85	82	122	160
Seat Width			B-Weight (lbs)		
20/ea.	20/ea.	20/ea.	38	57	75
Seat Depth			Cube (in ³)		
20	20	20	21	31	41
Seat Height					
19	19	19			
Back Height					
32	32	32			
Arm Height					
26	26	26			

Note: Width and depth are inside dimensions



Series	Model #	Type	A	B / COM	C	D	E	Leather Combo	All Leather
Reception 1000G									
	1000-2 Gang	2-Seater	810	875	910	1,070	1,235	1,235	1,370
	1000-3 Gang	3-Seater	1,220	1,320	1,370	1,605	1,855	1,855	2,065
	1000-4 Gang	4-Seater	1,630	1,755	1,825	2,135	2,470	2,470	2,745

TABLE OF CONTENTS

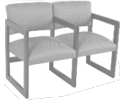
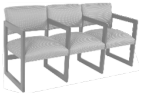

1500-3G

Model#			Model#		
1500-2G	1500-3G	1500-4G	1500-2G	1500-3G	1500-4G
Overall Depth (in)			COM (yards)		
26	26	26	3.00	4.00	5.00
Overall Width			Carton (\$)		
43	64	85	82	122	160
Seat Width			B-Weight (lbs)		
20/ea.	20/ea.	20/ea.	38	57	75
Seat Depth			Cube (in ³)		
20	20	20	21	31	41
Seat Height					
19	19	19			
Back Height					
32	32	32			
Arm Height					
26	26	26			

Note: Width and depth are inside dimensions



Series	Model #	Type	A	B / COM	C	D	E	Leather Combo	All Leather
Reception 1500G									
	1500-2 Gang	2-Seater	1,035	1,090	1,135	1,285	1,450	1,450	1,590
	1500-3 Gang	3-Seater	1,555	1,645	1,695	1,920	2,175	2,175	2,390
	1500-4 Gang	4-Seater	2,075	2,195	2,270	2,565	2,900	2,900	3,175

TABLE OF CONTENTS



2407

Model#	2407	Model#	2407
Overall Depth (in)	29	COM (yards)	3.00
Overall Width	34	Carton (\$)	146
Seat Width	30	B-Weight (lbs)	44
Seat Depth	27	Cube (in ³)	50
Seat Height	20		
Back Height	34		
Arm Height	26		

Note: Width and depth are inside dimensions

Series	Model #	Type	A	B / COM	C	D	E	Leather Combo	All Leather
Reception 2400	Traditional Diamond Stitching High Resilient Foam								
	2407	Single Seat Bariatric Chair	1,635	1,825	1,890	2,250	2,460	2,460	2,865



TABLE OF CONTENTS



5505G

Model#			Model#		
5505	5506	5507	5505	5506	5507
Overall Depth (in)			COM (yards)		
28	28	28	4.00	6.00	4.00
Overall Width			Carton (\$)		
44	64	68	82	122	122
Seat Width			B-Weight (lbs)		
40	60	64	43	62	58
Seat Depth			Cube (in ³)		
19	19	19	24	35	35
Seat Height					
19	19	19			
Back Height					
34	34	34			
Arm Height					
26	26	26			

Note: Width and depth are inside dimensions

Series	Model #	Type	A	B / COM	C	D	E	Leather Combo	All Leather
Reception 5500									
	5505	2-Seat Sofa	1,165	1,320	1,380	1,610	1,795	1,795	2,070
	5506	3-Seat Sofa	1,720	1,950	2,050	2,355	2,660	2,660	3,080
	5507	Seat/Table Seat	1,715	1,825	1,895	2,140	2,355	2,355	2,630

Note: Pricing is without arm in the middle. Add \$53 list for each arm.

TABLE OF CONTENTS



6505G

Model#			Model#		
6505	6506	6507	6505	6506	6507
Overall Depth (in)			COM (yards)		
28	28	28	4.00	6.00	4.00
Overall Width			Carton (\$)		
44	64	68	82	122	122
Seat Width			B-Weight (lbs)		
40	60	64	43	62	58
Seat Depth			Cube (in ³)		
19	19	19	24	35	35
Seat Height					
19	19	19			
Back Height					
34	34	34			
Arm Height					
26	26	26			

Note: Width and depth are inside dimensions



Series	Model #	Type	A	B / COM	C	D	E	Leather Combo	All Leather
Reception 6500									
	6505	2-Seat Sofa	1,235	1,350	1,425	1,600	1,810	1,810	2,090
	6506	3-Seat Sofa	1,840	2,015	2,105	2,500	2,850	2,850	3,270
	6507	Seat/Table Seat	1,775	1,935	1,995	2,250	2,485	2,485	2,755

TABLE OF CONTENTS



Model#	8707	Model#	8707
Overall Depth (in)	25	COM (yards)	3.00
Overall Width	33	Carton (\$)	146
Seat Width	30	B-Weight (lbs)	40
Seat Depth	19	Cube (in ³)	50
Seat Height	19		
Back Height	34		
Arm Height	26		

Note: Width and depth are inside dimensions

8707

Series	Model #	Type	A	B / COM	C	D	E	Leather Combo	All Leather
Reception 8700	High Resilient Foam								
	8707	Single Seat Bariatric Chair	1,685	1,905	2,055	2,345	2,595	2,595	3,045

*Add \$122 list for Dura Surface

TABLE OF CONTENTS

Model#			Model#		
9500-2G	9500-3G	9500-4G	9500-2G	9500-3G	9500-4G
Overall Depth (in)			COM (yards)		
26	26	26	4.00	6.00	8.00
Overall Width			Carton (\$)		
44	65	86.5	82	122	181
Seat Width			B-Weight (lbs)		
20/ea.	20/ea.	20/ea.	42	63	84
Seat Depth			Cube (in ³)		
19	19	19	22	32	43
Seat Height					
19	19	19			
Back Height					
33	33	33			
Arm Height					
26	26	26			

Note: Width and depth are inside dimensions



9500-4G



Series	Model #	Type	A	B / COM	C	D	E	Leather Combo	All Leather
Reception 9500G									
	9500-2 Gang	2-Seater	1,535	1,660	1,720	1,965	2,240	2,240	2,525
	9500-3 Gang	3-Seater	2,300	2,490	2,575	2,945	3,370	3,370	3,645
	9500-4 Gang	4-Seater	3,065	3,315	3,435	3,920	4,490	4,490	5,045

TABLE OF CONTENTS



FCF1-3G

Model#			Model#		
FCF1-2G	FCF1-3G	FCF1-4G	FCF1-2G	FCF1-3G	FCF1-4G
Overall Depth (in)			COM (yards)		
25	25	25	4.00	6.00	8.00
Overall Width			Carton (\$)		
44	65	86	82	122	181
Seat Width			B-Weight (lbs)		
20/ea.	20/ea.	20/ea.	44	66	88
Seat Depth			Cube (in ³)		
19	19	19	22	33	42
Seat Height					
19	19	19			
Back Height					
34	34	34			
Arm Height					
26	26	26			

Note: Width and depth are inside dimensions



Series	Model #	Type	A	B / COM	C	D	E	Leather Combo	All Leather
Reception FCF1									
	FCF1-2G	2-Seater	1,460	1,570	1,630	1,875	2,155	2,240	2,575
	FCF1-3G	3-Seater	2,195	2,350	2,430	2,805	3,225	3,370	3,845
	FCF1-4G	4-Seater	2,930	3,145	3,240	3,745	4,300	4,490	5,145

TABLE OF CONTENTS



Model#		Model#	
FCF7	FCF8	FCF7	FCF8
Overall Depth (in)		COM (yards)	
25	25	3.00	2.00
Overall Width		Carton (\$)	
33	23	146	74
Seat Width		B-Weight (lbs)	
30	20	50	32
Seat Depth		Cube (in ³)	
19	19	18	14
Seat Height			
19	26		
Back Height			
34	41		
Arm Height			
26	33		

FCF8



Series	Model #	Type	A	B / COM	C	D	E	Leather Combo	All Leather
Reception FCF7/8									
	FCF7	Bariatric Chair	1,550	1,735	1,865	2,130	2,350	2,350	2,815
	FCF8	Hip Stool	865	910	940	1,055	1,185	1,230	1,490



TABLE OF CONTENTS



FCF11-2G

Model#			Model#		
FCF11-2G	FCF11-3G	FCF11-4G	FCF11-2G	FCF11-3G	FCF11-4G
Overall Depth (in)			COM (yards)		
25	25	25	4.00	6.00	8.00
Overall Width			Carton (\$)		
44	65	86	86	130	176
Seat Width			B-Weight (lbs)		
20/ea.	20/ea.	20/ea.	44	66	88
Seat Depth			Cube (in ³)		
19	19	19	22	33	42
Seat Height					
19	19	19			
Back Height					
34	34	34			
Arm Height					
26	26	26			

Note: Width and depth are inside dimensions

Series	Model #	Type	A	B / COM	C	D	E	Leather Combo	All Leather
Reception FCF11									
	FCF11-2G	2-Seater	1,515	1,630	1,680	1,920	2,205	2,300	2,630
	FCF11-3G	3-Seater	2,280	2,375	2,520	2,890	3,310	3,450	3,945
	FCF11-4G	4-Seater	3,040	3,255	3,365	3,855	4,410	4,605	5,255

Note: Pricing is with arm in the middle

[Back to main Tables of Contents](#)

Click image to jump page

	
#2700	#2770
pg. 131	pg. 132



	
#2800	#2810
pg. 133	pg. 134





TABLE OF CONTENTS



2700

Model#					Model#				
2700	2701	2702	2704	2705	2700	2701	2702	2704	2705
Overall Depth (in)					COM (yards)				
34	25	25	34	36	4.25	2.00	2.00	4.25	4.75
Overall Width					Carton (\$)				
30	26	26	30	30	49	36	36	53	53
Seat Width					B-Weight (lbs)				
21	20	20	21	21	38	38	38	42	42
Seat Depth					Cube (in ³)				
19.5	19.5	19.5	19.5	19.5	24	11	11	24	31
Seat Height									
19	19	19	19	19					
Back Height									
40	30	30	44	50					
Arm Height									
29	25	25	28	28					

Note: Width and depth are inside dimensions

Series	Model #	Type	A	B / COM	C	D	E	Leather Combo	All Leather
Traditional 2700	Traditional Style Tufted Seat & Back								
	2700	Guest Chair	1,135	1,245	1,355	1,565	1,820	1,870	2,455
	2701	Leg Chair	650	720	795	865	1,010	1,010	1,185
	2702	Leg Caster Chair	690	765	840	910	1,055	1,075	1,225
	2704	Jr Ex - Low Back Chair	1,365	1,475	1,585	1,800	2,060	2,160	2,750
	2705	Ex - High Back Chair	1,575	1,725	1,870	2,010	2,305	2,375	3,100

*Note: Pricing shows alder wood in, A-Sienna, A-Espresso, A-Mahogany, and A-Light Cherry
Add \$122 list for Walnut, Cherry, Oak, or Maple Wood*



TABLE OF CONTENTS



2774

Model#			Model#		
2770	2774	2775	2770	2774	2775
Overall Depth (in)			COM (yards)		
34	34	36	4.25	4.25	4.75
Overall Width			Carton (\$)		
30	30	30	56	56	56
Seat Width			B-Weight (lbs)		
21	21	21	40	60	65
Seat Depth			Cube (in ³)		
19.5	19.5	19.5	24	24	31
Seat Height					
19	19	19			
Back Height					
40	44	50			
Arm Height					
27	28	28			

Note: Width and depth are inside dimensions

Series	Model #	Type	A	B / COM	C	D	E	Leather Combo	All Leather
Traditional 2770									
	2770	Guest Chair	1,070	1,180	1,290	1,505	1,755	1,800	2,320
	2774	Jr Ex - Low Back Chair	1,305	1,410	1,525	1,740	1,990	2,105	2,685
	2775	Ex - High Back Chair	1,515	1,660	1,800	1,955	2,235	2,310	3,085

*Note: Pricing shows alder wood in, A-Sienna, A-Espresso, A-Mahogany, and A-Light Cherry
Add \$122 list for Walnut, Cherry, Oak, or Maple Wood*



TABLE OF CONTENTS



2801

Model#	Model#		
2801, 2802, 2804	2801	2802	2804
Overall Depth (in)	COM (yards)		
27	3.00	3.00	3.00
Overall Width	Carton (\$)		
26	40	40	56
Seat Width	B-Weight (lbs)		
20	21	21	35
Seat Depth	Cube (in ³)		
19.5	14	14	14
Seat Height			
19			
Back Height			
34			
Arm Height			
26			

Note: Width and depth are inside dimensions

Series	Model #	Type	A	B / COM	C	D	E	Leather Combo	All Leather
Traditional 2800	High Resilient Foam								
	2801	Leg Chair	810	870	955	1,020	1,240	1,240	1,615
	2802	Leg Caster Chair	865	920	1,000	1,070	1,285	1,285	1,735
	2804	Jr Ex - Low Back Chair	1,140	1,210	1,280	1,355	1,570	1,570	2,015

*Note: Pricing shows alder wood in, A-Sienna, A-Espresso, A-Mahogany, and A-Light Cherry
Add \$140 list for Walnut, Cherry, Oak, or Maple Wood*



TABLE OF CONTENTS



2811

Model#	Model#		
2811, 2812, 2814	2811	2812	2814
Overall Depth (in)	COM (yards)		
27	3.00	3.00	3.00
Overall Width	Carton (\$)		
26	40	40	56
Seat Width	B-Weight (lbs)		
20	21	21	35
Seat Depth	Cube (in ³)		
19.5	14	14	14
Seat Height			
19			
Back Height			
34			
Arm Height			
26			

Note: Width and depth are inside dimensions

Series	Model #	Type	A	B / COM	C	D	E	Leather Combo	All Leather
Traditional 2810	High Resilient Foam Tufted Back								
	2811	Leg Chair	965	1,010	1,085	1,170	1,370	1,370	1,825
	2812	Leg Caster Chair	980	1,055	1,130	1,200	1,420	1,420	1,845
	2814	Jr Ex - Low Back Chair	1,255	1,345	1,400	1,490	1,735	1,735	2,160

*Note: Pricing shows alder wood in, A-Sienna, A-Espresso, A-Mahogany, and A-Light Cherry
Add \$140 list for Walnut, Cherry, Oak, or Maple Wood*

CASE GOODS

PRODUCT BREAKDOWN

Laminate | Laminate w/Wood Edge | Wood Veneer

 <p><i>PONY</i></p> <p><i>1 SELECTION</i></p>	<p>LAMINATE</p>
 <p><i>FLOW</i></p>  <p><i>ECHO</i></p>  <p><i>FLUTED-L</i></p>  <p><i>CONCORD-L</i></p> <p><i>10 SELECTIONS</i></p>	<p>LAMINATE W/WOOD EDGE</p>
 <p><i>ARISTOCRAT</i></p>  <p><i>ROW</i></p>  <p><i>FLUTED-V</i></p>  <p><i>CONCORD-V</i></p> <p><i>15 SELECTIONS</i></p>	<p>WOOD VENEER</p>

PRODUCT BREAKDOWN – OPTIONS/FEATURES

Type	LAMINATE	LAMINATE W/WOOD EDGE				WOOD VENEER			
Series	<i>Pony</i>	<i>Flow</i>	<i>Echo</i>	<i>Fluted-L</i>	<i>Concord-L</i>	<i>Aristocrat</i>	<i>Row</i>	<i>Fluted-V</i>	<i>Concord-V</i>
Edges	Pony	Flow	Echo Beveled Square Matrix	Fluted-L Saga-L	Concord-L* Victory-L	Aristocrat Beveled Square Matrix	Row Row 2 Row-Beveled Row-Reverse-Beveled Row-Fluted Row-Saga	Fluted-V Saga-V	Concord-V* Victory-V
Top Surface	Thermafuse Laminate					Veneer			
Top Edge	PVC Edge	Solid Wood: 1-1/8"				Solid Wood: 1-1/4"	Solid Wood: 2"	Solid Wood: 1-1/4"	
End Panel Edge	PVC Edge					Veneer			
Modesty Panel	TF Laminate					Veneer			
Pedestals	Hanging				Floor* Hanging	Hanging			Floor* Hanging
Pedestal Side	TF Laminate					Veneer			
Drawer-Front	TF Laminate					Veneer			
Drawer-Interior	Birch Veneer								
Dictation Slide	Optional								
Center Drawer	Optional								
Keyboard	Optional								
Drawer Slides	BIFMA Certified								
Box Drawer Slide	100 lbs., Ball Bearing, Full Extension								
File Drawer Slide	100 lbs., Ball Bearing, Full Extension								
Lateral File	150 lbs., Ball Bearing, Full Extension								
Vertical File	150 lbs., Ball Bearing, Full Extension								
Pedestal Lock	One Lock Standard on Main Desk only								
Face Lock	Standard on Lateral & Vertical Files								
Drawer Pulls	Optional				Standard on Concord	Optional			Standard on Concord
Pulls on Lat/Vert Files	Standard					Optional			Standard on Concord
Finishes	Black (B) Charcoal (A) Cognac (X) Espresso (K) Graphite (R) Grey (D) Lakewood (Q) Mahogany (M) Maple (E) Oak (O) Seaboard (S) Spectrum Grey (P) White (Z) Wild Cherry (H)					Amber (AB) Blackwash (BW) Cherry on Cherry (CC) Cocoa (CV) Cognac (XV) Espresso (EV) Honey Cherry (HC) Greywash (GW) Koala (KV) Light Cherry (LC) Light Oak (LO) Mahogany (MV) Med. Mahogany (MM) Med. Oak (MO) Nat. Cherry (NC) Nat. Oak (NO) Natural Maple (NM) Natural Walnut (NW) Pecan (PV) Rustic (RV) Sienna (SV) Sunburst (SUV) Walnut (WV) Whitewash (WV)			

[Back to main Tables of Contents](#)

Click text to jump page

<i>pg. 139</i>	<u>LAMINATE</u>
<i>pg. 163</i>	<u>LAMINATE W/WOOD EDGE</u>
<i>pg. 210</i>	<u>WOOD VENEER</u>

[Back to main Table of Contents](#)

Click text to jump page

SERIES

<p><i>pg. 140</i></p>	<p><u>PONY</u></p>	 <p>(P)</p>
-----------------------	--------------------	--

TABLE OF CONTENTS

LAMINATE
PONY

TABLE OF CONTENTS

Click text to jump page





<i>pg. 141</i>	<u>DESKS</u>	
<i>pg. 145</i>	<u>DESK UNITS</u>	
<i>pg. 151</i>	<u>BRIDGES/RETURNS</u>	
<i>pg. 153</i>	<u>CREDENZAS</u>	
<i>pg. 157</i>	<u>FILES/STORAGE</u>	
<i>pg. 160</i>	<u>BOOKCASES</u>	
<i>pg. 161</i>	<u>HUTCHES</u>	

TABLE OF CONTENTS

Configuration	Quick Model	Quick Size	Size	Pony	Carton	B-Weight	Cube
Desk Shell No Ped ¾ Modesty – add \$79 for Full (FM)							
	S	A	24x48	581	101	102	24
	S	B	24x60	644	135	120	30
	S	C	24x66	773	135	125	32
	S	D	24x72	773	135	135	35
	S	E	30x48	644	135	120	28
	S	F	30x60	707	135	140	36
	S	G	30x66	773	135	148	35
	S	H	30x72	837	135	154	42
	S	I	36x72	901	135	180	50
	S	J	36x78	1,030	179	190	54

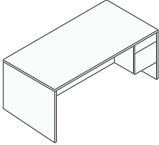
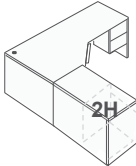
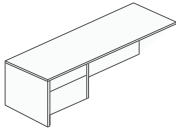
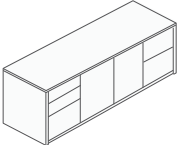
FAN TOP

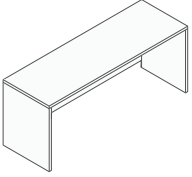

Add \$364 list for 6" fan top (FT)

RIGHT OR LEFT

Specify (RP) for Right Pedestal or (LP) for Left Pedestal

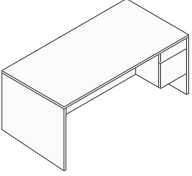
Desk Single ¾ Ped ¾ Modesty – add \$79 for Full (FM)							
	S3	A	24x48	837	101	150	24
	S3	B	30x48	901	101	170	24
	S3	C	30x60	1,004	135	185	28
	S3	D	30x66	1,030	179	195	30
	S3	E	30x72	1,093	101	205	24
	S3	F	36x72	1,157	135	230	30
	S3	G	36x78	1,288	179	240	32

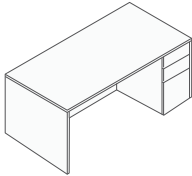
Desk Single Full Ped Full Modesty							
	FP	A	24x48	1,008	135	160	28
	FP	B	30x48	1,074	135	170	32
	FP	C	30x60	1,137	135	190	40
	FP	D	30x66	1,201	135	210	44
	FP	E	30x72	1,268	135	230	48
	FP	F	36x72	1,330	179	250	54
	FP	G	36x78	1,456	179	280	58

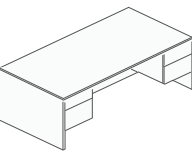
Desk Double ¾ Ped ¾ Modesty – add \$79 for Full (FM)							
	D3	A	30x60	1,222	135	232	36
	D3	B	30x66	1,330	135	242	40
	D3	C	30x72	1,353	135	250	44
	D3	D	36x72	1,416	135	270	50
	D3	E	36x78	1,542	179	285	54

Desk Double Full Ped Full Modesty							
	DF	A	30x60	1,563	135	290	36
	DF	B	30x66	1,633	135	300	40
	DF	C	30x72	1,696	135	310	42
	DF	D	36x72	1,758	135	330	50
	DF	E	36x78	1,889	179	340	54

TABLE OF CONTENTS

Configuration	Quick Model	Quick Size	Size	Pony	Carton	B-Weight	Cube
Computer Desk – Corner Table							
	CCT	A	20-30x30	659	135	80	20
	CCT	B	20-36x36	765	135	100	25
	CCT	C	20-42x42	873	135	124	35
	CCT	D	20-48x48	981	135	150	45
	CCT	E	24-36x36	981	135	110	30
	CCT	F	24-42x42	1,089	135	120	35
	CCT	G	24-48x48	1,195	135	155	42

FAN TOP

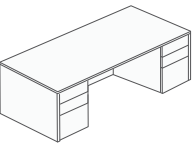
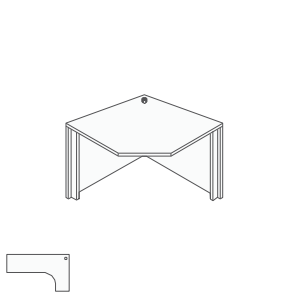

Add \$364 list for 6" fan top (FT)

RADIAL CORNER



Add \$158 list for radial corner (RC)

RIGHT OR LEFT

Specify (RP) for Right Pedestal or (LP) for Left Pedestal

NOTE

Black grommet standard

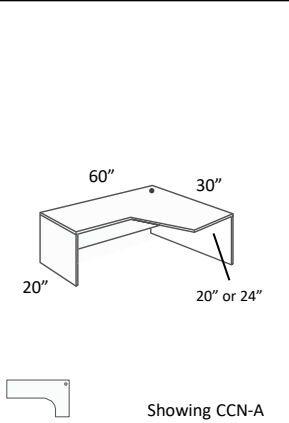
Computer Desk No Ped ¾ Modesty – add \$79 for Full (FM)							
	CCN	A	20-60x30	882	135	184	36
	CCN	B	20-66x30	924	135	192	40
	CCN	C	20-72x30	967	135	210	44
	CCN	D	20-78x30	1,009	179	230	60
	CCN	E	24-66x36	967	135	200	46
	CCN	F	24-72x36	1,009	135	210	50
	CCN	G	24-78x36	1,052	179	230	60
	CCN	H	30-66x42	1,116	135	250	54
	CCN	I	30-72x42	1,177	135	260	60
	CCN	J	30-78x42	1,245	179	272	64
	CCN	K	36-72x48	1,330	135	285	68
	CCN	L	36-78x48	1,458	179	300	70

Computer Desk ¼ Ped ¾ Modesty – add \$79 for Full (FM)							
	CCS	A	20-60x30	1,138	135	220	36
	CCS	B	20-66x30	1,177	135	230	40
	CCS	C	20-72x30	1,222	135	242	42
	CCS	D	20-78x30	1,268	179	260	46
	CCS	E	24-66x36	1,222	135	230	46
	CCS	F	24-72x36	1,268	135	250	52
	CCS	G	24-78x36	1,309	179	260	56
	CCS	H	30-66x42	1,372	135	250	52
	CCS	I	30-72x42	1,438	135	260	56
	CCS	J	30-78x42	1,502	179	275	60
	CCS	K	36-72x48	1,586	135	275	60
	CCS	L	36-78x48	1,719	179	285	64

TABLE OF CONTENTS

Configuration	Quick Model	Quick Size	Size	Pony	Carton	B-Weight	Cube
Computer Desk Full Ped Full Modesty							
	CDF	A	20-60x30	1,308	135	190	36
	CDF	B	20-66x30	1,353	135	200	40
	CDF	C	20-72x30	1,394	135	225	50
	CDF	D	20-78x30	1,438	179	235	54
	CDF	E	24-66x36	1,394	135	245	46
	CDF	F	24-72x36	1,438	135	255	50
	CDF	G	24-78x36	1,478	179	265	54
	CDF	H	30-66x42	1,544	135	265	54
	CDF	I	30-72x42	1,611	135	275	60
	CDF	J	30-78x42	1,674	179	285	64
	CDF	K	36-72x48	1,758	135	300	68
	CDF	L	36-78x48	1,889	179	320	72

FAN TOP

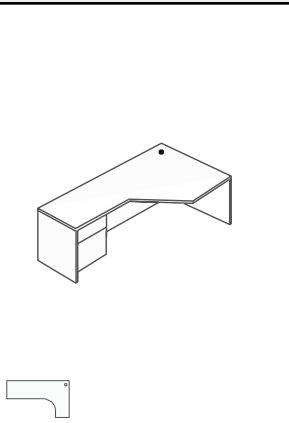

Add \$347 list for 6" fan top (FT)

RADIAL CORNER



Add \$158 list for radial corner (RC)

Computer Desk Lateral File w/Black Pulls Full Modesty							
	DL	A	20-72x30	1,889	135	230	44
	DL	B	20-78x30	1,929	179	240	48
	DL	C	24-72x36	1,929	135	255	50
	DL	D	24-78x36	1,975	179	265	54
	DL	E	30-72x42	2,105	135	265	60
	DL	F	30-78x42	2,166	179	305	64
	DL	G	36-72x48	2,251	135	320	68
	DL	H	36-78x48	2,381	179	340	72

RIGHT OR LEFT

Specify (RP) for Right Pedestal or (LP) for Left Pedestal

NOTE

Black grommet standard

Computer Desk Personal Lateral File w/Black Pulls Full Modesty							
	CP	A	20-72X30	2,105	135	238	44
	CP	B	20-78x30	2,208	179	248	48
	CP	C	24-72x36	2,208	135	273	50
	CP	D	24-78x36	2,251	179	263	54
	CP	E	30-72x42	2,381	135	293	60
	CP	F	30-78x42	2,445	179	313	64
	CP	G	36-72x48	2,530	135	328	68
	CP	H	36-78x48	2,660	179	348	72

TABLE OF CONTENTS

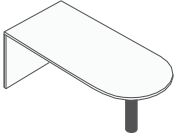
Configuration	Quick Model	Quick Size	Size	Pony	Carton	B-Weight	Cube
Bullet Desk No Ped ¾ Modesty – add \$79 for Full (FM)							
	BN	A	30x60	1,137	116	130	36
	BN	B	30x66	1,268	116	154	42
	BN	C	30x72	1,268	116	145	43
	BN	D	36x72	1,330	116	165	50
	BN	E	36x78	1,544	153	200	64
	BN	F	42x84	1,758	153	220	68

NOTE
BN model not intended for sale as freestanding desk. See bridges and returns.

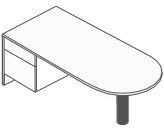
Bullet Desk ¾ Ped ¾ Modesty – add \$79 for Full Mod(FM)							
	BS	A	30x60	1,394	116	235	42
	BS	B	30x66	1,523	116	235	42
	BS	C	30x72	1,523	116	245	50
	BS	D	36x72	1,586	153	265	54
	BS	E	36x78	1,804	153	275	64
	BS	F	42x84	2,018	153	285	68

POST
Standard in black
Available in silver, add \$32 list

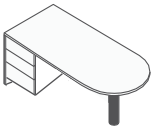
Bullet Desk Full Ped Full Modesty							
	BF	A	30x60	1,520	116	230	38
	BF	B	30x66	1,652	116	240	40
	BF	C	30x72	1,652	116	250	40
	BF	D	36x72	1,718	116	265	42
	BF	E	36x78	1,928	153	275	46
	BF	F	42x84	2,143	153	310	50

RIGHT OR LEFT
Specify (RP) for Right Pedestal or (LP) for Left Pedestal

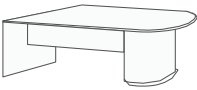
½ Cylinder Desk No Ped add \$79 for Full Modesty (FM)							
	BCN	A	30x60	1,674	116	255	42
	BCN	B	30x66	1,804	116	270	44
	BCN	C	30x72	1,804	116	270	44
	BCN	D	36x72	1,865	116	285	48
	BCN	E	36x78	2,082	153	310	60
	BCN	F	42x84	2,295	153	330	64

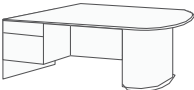
½ Cylinder Desk ¾ Ped ¾ Modesty – add \$79 for Full (FM)							
	BCS	A	30x60	1,929	116	260	40
	BCS	B	30x66	2,059	116	280	42
	BCS	C	30x72	2,059	116	300	44
	BCS	D	36x72	2,123	116	320	44
	BCS	E	36x78	2,340	153	340	52
	BCS	F	42x84	2,551	153	350	64

½ Cylinder Desk Full Ped Full Modesty							
	BCF	A	30x60	2,059	116	270	42
	BCF	B	30x66	2,190	116	270	44
	BCF	C	30x72	2,190	116	310	46
	BCF	D	36x72	2,251	116	320	48
	BCF	E	36x78	2,466	153	340	54
	BCF	F	42x84	2,681	153	360	64

TABLE OF CONTENTS

Configuration	Quick Model	Quick Size	Size	Pony	Carton	B-Weight	Cube
L-Shaped Desk ¾ Ped ¾" Modesty – add \$158 for Full (FM)							
	D	1	30x66 Desk 24x42 Return	1,858	240	300	64
	D	2	36x72 Desk 24x48 Return	2,027	240	355	75
L-Shaped Desk Full Ped Full Modesty							
	D	3	36x72 Desk 24x48 Return	2,381	240	410	75
L-Shaped Computer Desk ¾ Ped ¾" Modesty – add \$158 for Full (FM)							
	D	4	36-72x48 Desk 24x48 Return	2,456	291	340	75
L-Shaped Computer Desk Full Ped Full Modesty							
	D	5	36-72x48 Desk 24x48 Return	2,809	291	367	75

FAN TOP

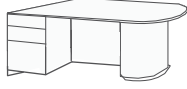
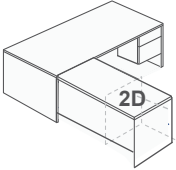
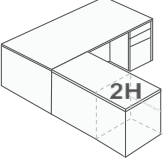
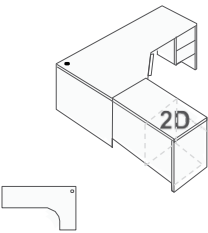
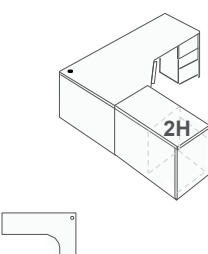

Add \$364 list for 6" fan top (FT)

RADIAL CORNER



Add \$158 list for radial corner (RC)

RIGHT OR LEFT

Specify (R) for Right Return or (L) for Left Return

NOTE

Black grommet are standard on Computer Desk

TABLE OF CONTENTS

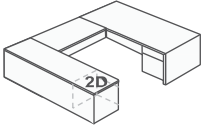
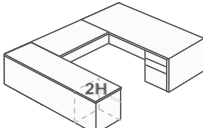
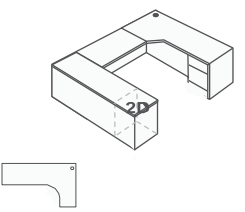
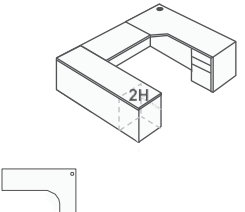
Configuration	Quick Model	Quick Size	Size	Pony	Carton	B-Weight	Cube
U-Shaped Desk ¾ Ped ¾" Modesty – add \$158 for Full (FM)							
	D	6	36X72 Desk 24x48 Bridge 24x72 Credenza	2,814	330	455	98
U-Shaped Desk Full Ped Full Modesty							
	D	7	36X72 Desk 24x48 Bridge 24x72 Credenza	3,159	330	580	115
U-Shaped Computer Desk ¾ Ped ¾" Modesty – add \$158 for Full (FM)							
	D	8	30-72x42 Desk 24x48 Bridge 24x72 Credenza	3,095	330	455	98
U-Shaped Computer Desk Full Ped Full Modesty							
	D	9	30-72x42 Desk 24x48 Bridge 24x72 Credenza	3,159	330	580	115

FAN TOP

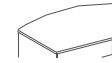

Add \$364 list for 6" fan top (FT)

RADIAL CORNER



Add \$158 list for radial corner (RC)



RIGHT OR LEFT

Specify (R) for Right Bridge or (L) for Left Bridge

NOTE

Black grommet are standard on Computer Desk

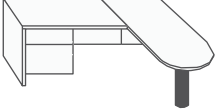
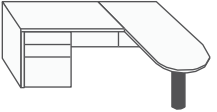
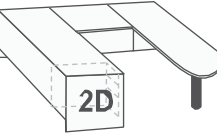
TABLE OF CONTENTS

Configuration	Quick Model	Quick Size	Size	Pony	Carton	B-Weight	Cube
L-Shaped Bullet Desk ¾ Ped ¾" Modesty – add \$158 for Full (FM)							
	D	10	36X72 Desk 24x48 Return	2,200	214	290	68
L-Shaped Bullet Desk Full Ped Full Modesty							
	D	11	36X72 Desk 24x48 Return	2,381	214	315	72
U-Shaped Bullet Desk ¾ Ped ¾" Modesty – add \$158 for Full (FM)							
	D	12	36x72 Desk 24x48 Bridge 24x72 Credenza	2,987	330	555	96
U-Shaped Bullet Desk Full Ped Full Modesty							
	D	13	36x72 Desk 24x48 Bridge 24x72 Credenza	3,159	330	583	96

POST
Standard in black
Available in silver, add \$32 list

RIGHT OR LEFT
Specify (R) for Right Bridge or (L) for Left Bridge

TABLE OF CONTENTS

Configuration	Quick Model	Quick Size	Size	Pony	Carton	B-Weight	Cube
Bullet Computer Desk Shell ¾ Modesty – add \$79 for Full (FM)							
<p>Showing D14-A</p>	D14	A	24-66X36	1,287	116	125	42
	D14	B	24-72X36	1,372	116	135	45
	D14	C	24-78X36	1,456	153	145	48
	D14	D	30-66X42	1,501	116	145	51
	D14	E	30-72X42	1,586	116	155	54
	D14	F	30-78X42	1,674	153	165	57
	D14	G	36-66X48	1,739	116	165	60
	D14	H	36-72X48	1,803	116	175	63
	D14	I	36-78X48	1,887	153	185	66
L-Shaped Bullet Computer Desk ¾ Ped ¾ Modesty – add \$158 for Full (FM)							
	D	15	30-72x42 Desk 24x48 Return	2,486	214	255	78
L-Shaped Bullet Computer Desk Full Ped Full Modesty							
	D	16	30-72x42 Desk 24x48 Return	2,659	214	285	78
U-Shaped Bullet Computer Desk ¾ Ped ¾ Modesty – add \$158 for Full (FM)							
	D	17	30-72x42 Desk 24x42 Bridge 24x72 Credenza	3,237	351	465	106
U-Shaped Bullet Computer Desk Full Ped Full Modesty							
	D	18	30-72x42 Desk 24x42 Bridge 24x72 Credenza	3,411	351	495	106

NOTE

D14 model not intended for sale as freestanding desk. See bridges and returns.

RADIAL CORNER



Add \$158 list for radial corner (RC)

POST

Standard in black

Available in silver, add \$32 list

RIGHT OR LEFT

Specify (R) for Right Bridge or (L) for Left Bridge

TABLE OF CONTENTS

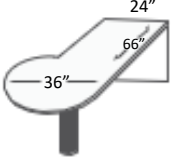
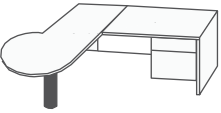
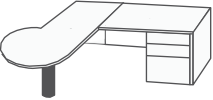
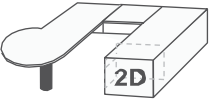
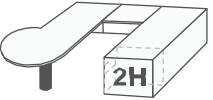
Configuration	Quick Model	Quick Size	Size	Pony	Carton	B-Weight	Cube
P-Shaped Desk Shell ¾ Modesty – add \$79 for Full (FM)							
 <p>Showing D19-A</p>	D19	A	36-66x24	1,372	116	105	42
	D19	B	36-72x24	1,438	123	120	45
	D19	C	36-78x24	1,501	136	135	49
	D19	D	42-66x30	1,633	123	150	48
	D19	E	42-72x30	1,696	136	165	53
	D19	F	42-78x30	1,758	143	180	57
	D19	G	48-66x36	1,824	136	195	55
	D19	H	48-72x36	1,887	143	210	60
	D19	I	48-78x36	1,953	153	225	66
L-Shaped P-Desk ¾ Ped ¾ Modesty – add \$158 for Full (FM)							
	D	20	48-78x36 Desk 24x48 Return	2,853	256	285	86
L-Shaped P-Desk Full Ped Full Modesty							
	D	21	48-78x36 Desk 24x48 Return	3,026	256	298	86
U-Shaped P-Desk ¾ Ped ¾ Modesty – add \$158 for Full (FM)							
	D	22	48-78x36 Desk 24x48 Bridge 24x78 Credenza	3,645	384	508	119
U-Shaped P-Desk Full Ped Full Modesty							
	D	23	48-78x36 Desk 24x48 Bridge 24x78 Credenza	4,247	384	538	119

NOTE

D19 model not intended for sale as freestanding desk. See bridges and returns.

POST

Standard in black

Available in silver, add \$32 list

RIGHT OR LEFT

Specify (R) for Right Bridge or (L) for Left Bridge

TABLE OF CONTENTS

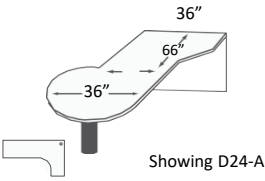
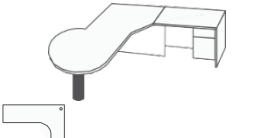
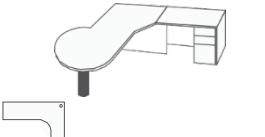
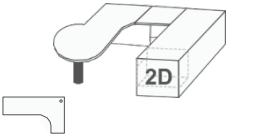
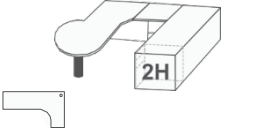
Configuration	Quick Model	Quick Size	Size	Pony	Carton	B-Weight	Cube
P-Shaped Computer Desk Shell ¾ Modesty – add \$79 for Full (FM)							
 <p>Showing D24-A</p>	D24	A	36-66x36	2,037	97	80	80
	D24	B	36-72x36	2,102	129	106	106
	D24	C	36-78x36	2,165	129	106	106
	D24	D	42-66x42	2,199	129	106	106
	D24	E	42-72x42	2,263	129	106	106
	D24	F	42-78x42	2,328	129	106	106
P-Shaped Computer Desk ¾ Ped ¾ Modesty – add \$158 for Full (FM)							
	D	25	36-78x36 Desk 24x48 Return	3,067	256	285	86
P-Shaped Computer Desk Full Ped Full Modesty							
	D	26	36-78x36 Desk 24x48 Return	3,237	256	298	86
P-Shaped Computer Desk ¾ Ped ¾ Modesty – add \$158 for Full (FM)							
	D	27	36-78x36 Desk 24x48 Bridge 24x78 Credenza	3,968	384	508	119
P-Shaped Computer Desk Full Ped Full Modesty							
	D	28	36-78x36 Desk 24x48 Bridge 24x78 Credenza	4,139	384	538	119

NOTE

D24 model not intended for sale as freestanding desk. See bridges and returns.

RADIAL CORNER



Add \$158 list for radial corner (RC)

POST

Standard in black

Available in silver, add \$32 list

RIGHT OR LEFT

Specify (R) for Right Bridge or (L) for Left Bridge

TABLE OF CONTENTS

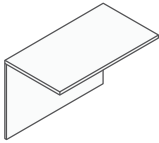
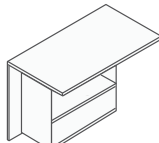
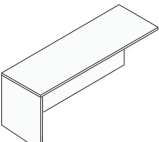
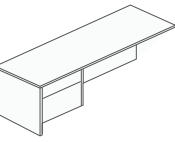
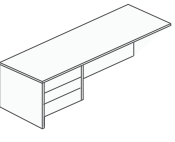
Configuration	Quick Model	Quick Size	Size	Pony	Carton	B-Weight	Cube
Bridge ¾ Mod w/2D Desk or Credenza Full Mod w/3H Desk or Credenza							
	B	A	20x36	456	101	55	15
	B	B	20x42	495	101	60	17
	B	C	20x48	540	101	65	19
	B	D	20x54	583	101	70	21
	B	E	24x36	497	101	60	18
	B	F	24x42	537	101	65	21
	B	G	24x48	583	101	70	24
	B	H	24x54	621	101	75	27
Bridge 12" Deep Bookcase							
	1BB	A	20x36	870	101	90	15
	1BB	B	20x42	911	101	95	17
	1BB	C	20x48	953	101	100	19
	1BB	D	20x54	996	101	105	21
	1BB	E	24x36	912	101	100	18
	1BB	F	24x42	950	101	105	21
	1BB	G	24x48	996	101	115	24
	1BB	H	24x54	1,034	101	125	27
Return Shell ¾ modesty – add \$79 for Full (FM)							
	R	A	20x36	496	101	55	15
	R	B	20x42	537	101	60	17
	R	C	20x48	581	101	65	19
	R	D	20x54	622	101	70	21
	R	E	24x36	538	101	75	18
	R	F	24x42	581	101	85	21
	R	G	24x48	622	101	60	24
	R	H	24x54	664	101	65	27
Return ¾ Ped (Box/File) ¾ modesty – add \$79 for Full (FM)							
	R2	A	20x36	747	101	75	15
	R2	B	20x42	786	101	80	17
	R2	C	20x48	829	101	85	19
	R2	D	20x54	870	101	90	21
	R2	E	24x36	786	101	80	18
	R2	F	24x42	828	101	85	21
	R2	G	24x48	870	101	100	24
	R2	H	24x54	912	101	115	27
Return ¾ Ped (Box/Box/Box) ¾ modesty – add \$79 for Full (FM)							
	R3	A	20x36	836	101	75	15
	R3	B	20x42	874	101	80	17
	R3	C	20x48	917	101	85	19
	R3	D	20x54	957	101	90	21
	R3	E	24x36	874	101	80	17
	R3	F	24x42	917	101	85	19
	R3	G	24x48	958	101	100	24
	R3	H	24x54	998	101	115	27

RIGHT OR LEFT
Specify (R) for Right or (L) for Left

TABLE OF CONTENTS

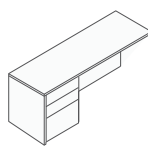
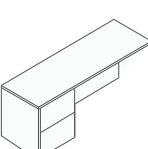
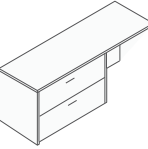
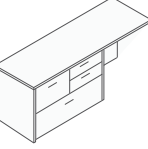
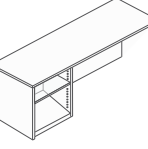
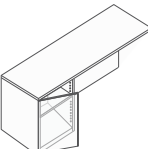
Configuration	Quick Model	Quick Size	Size	Pony	Carton	B-Weight	Cube
Return Full Ped (Box/Box/File) Full Modesty							
	RF	A	20x36	924	101	105	15
	RF	B	20x42	966	101	115	17
	RF	C	20x48	1,009	101	125	19
	RF	D	20x54	1,052	101	135	21
	RF	E	24x36	966	101	140	18
	RF	F	24x42	1,010	101	150	24
	RF	G	24x48	1,051	101	155	24
	RF	H	24x54	1,091	101	160	27
Return Full Ped (File/File) Full Modesty							
	RL	A	20x36	924	101	105	15
	RL	B	20x42	966	101	115	17
	RL	C	20x48	1,009	101	125	19
	RL	D	20x54	1,052	101	135	21
	RL	E	24x36	966	101	140	18
	RL	F	24x42	1,010	101	150	21
	RL	G	24x48	1,051	101	155	24
	RL	H	24x54	1,091	101	160	27
Return Lateral File w/Standard Black Pulls Full Modesty							
	RLF	A	20x48	1,507	101	175	19
	RLF	B	20x54	1,548	101	180	21
	RLF	C	20x60	1,590	101	185	24
	RLF	D	24x48	1,548	101	180	24
	RLF	E	24x54	1,590	101	185	27
	RLF	F	24x60	1,632	101	190	29
Return Personal Lateral File w/Standard Black Pulls Full Modesty							
	PF	A	20x48	1,750	101	184	19
	PF	B	20x54	1,793	101	189	21
	PF	C	20x60	1,832	101	194	24
	PF	D	24x48	1,793	101	184	24
	PF	E	24x54	1,832	101	189	27
	PF	F	24x60	1,878	101	194	30
Return Personal Printer w/Adjustable Shelf Full Modesty							
	PP	A	20x48	1,013	101	92	19
	PP	B	20x54	1,054	101	102	21
	PP	C	20x60	1,096	101	112	24
	PP	D	24x48	1,054	101	122	24
	PP	E	24x54	1,096	101	132	27
	PP	F	24x60	1,138	101	142	30
Return Personal Printer w/Door Full Modesty							
	PPD	A	20x48	1,209	101	92	19
	PPD	B	20x54	1,250	101	102	21
	PPD	C	20x60	1,293	101	112	24
	PPD	D	24x48	1,250	101	122	24
	PPD	E	24x54	1,293	101	132	27
	PPD	F	24x60	1,334	101	142	30

RIGHT OR LEFT
Specify (R) for Right Return or
(L) for Left Return

PULLS
Black pulls are standard on
Lateral Files

TABLE OF CONTENTS

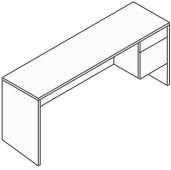
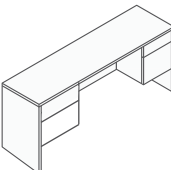
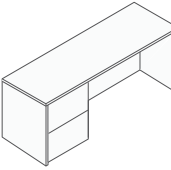
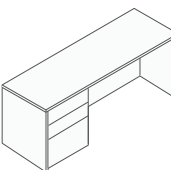
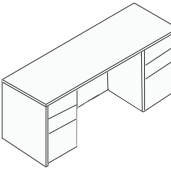
Configuration	Quick Model	Quick Size	Size	Pony	Carton	B-Weight	Cube
Kneespace Credenza ¼ Ped ¼ Modesty – add \$79 for Full (FM)							
	C3	A	20x60	885	116	175	22
	C3	B	20x66	949	116	180	26
	C3	C	20x72	1,013	116	185	28
	C3	D	20x78	1,074	153	190	30
	C3	E	24x60	949	116	180	26
	C3	F	24x66	1,013	116	185	28
	C3	G	24x72	1,074	116	190	30
	C3	H	24x78	1,180	153	200	32
Kneespace Credenza Double ¼ Ped ¼ Modesty – add \$79 for Full (FM)							
	CK	A	20x60	1,201	135	195	24
	CK	B	20x66	1,268	135	205	26
	CK	C	20x72	1,330	135	215	28
	CK	D	20x78	1,394	179	225	30
	CK	E	24x60	1,268	135	205	26
	CK	F	24x66	1,330	135	215	28
	CK	G	24x72	1,394	135	225	30
	CK	H	24x78	1,458	179	235	32
Kneespace Credenza Full Ped (File/File) Full Modesty							
	CSP	A	20x60	1,054	135	182	22
	CSP	B	20x66	1,117	135	192	26
	CSP	C	20x72	1,180	135	202	28
	CSP	D	20x78	1,246	179	212	30
	CSP	E	24x60	1,117	135	187	26
	CSP	F	24x66	1,180	135	192	28
	CSP	G	24x72	1,246	135	222	30
	CSP	H	24x78	1,348	179	232	32
Kneespace Credenza Full Ped (Box/Box/File) Full Modesty							
	CS3	A	20x60	1,054	122	182	22
	CS3	B	20x66	1,117	122	192	26
	CS3	C	20x72	1,180	122	202	28
	CS3	D	20x78	1,246	162	212	30
	CS3	E	24x60	1,117	122	187	26
	CS3	F	24x66	1,180	122	192	28
	CS3	G	24x72	1,246	122	222	30
	CS3	H	24x78	1,348	162	232	32
Kneespace Credenza Double Full Ped Full Modesty							
	CN	A	20x60	1,544	135	185	24
	CN	B	20x66	1,611	135	190	26
	CN	C	20x72	1,674	135	198	28
	CN	D	20x78	1,739	179	210	30
	CN	E	24x60	1,611	135	190	26
	CN	F	24x66	1,674	135	198	28
	CN	G	24x72	1,739	135	210	30
	CN	H	24x78	1,804	179	220	32

RIGHT OR LEFT
Specify (R) for Right Ped or Left
(L) or Left Ped on credenza
w/single ped

TABLE OF CONTENTS

Configuration	Quick Model	Quick Size	Size	Pony	Carton	B-Weight	Cube
Credenza ¾ Storage w/Hinged Doors ¾ Modesty – add \$79 for Full (FM)							
	CS	A	20x60	1,223	135	175	22
	CS	B	20x66	1,287	135	180	26
	CS	C	20x72	1,353	135	185	28
	CS	D	20x78	1,417	179	190	30
	CS	E	24x60	1,287	135	180	26?
	CS	F	24x66	1,353	135	185	28
	CS	G	24x72	1,417	135	190	30
	CS	H	24x78	1,478	179	200	32
Credenza Full Storage w/Hinged Doors							
	CT	A	20x60	1,755	135	185	24
	CT	B	20x66	1,817	135	190	26
	CT	C	20x72	1,883	135	195	28
	CT	D	20x78	1,948	179	200	30
	CT	E	24x60	1,817	135	190	26
	CT	F	24x66	1,883	135	195	28
	CT	G	24x72	1,948	135	200	30
	CT	H	24x78	2,013	179	205	32
Credenza ¾ Ped w/Hinged Doors ¾ Modesty – add \$79 for Full (FM)							
	CA	A	20x60	1,265	135	220	24
	CA	B	20x66	1,330	135	225	26
	CA	C	20x72	1,391	135	230	28
	CA	D	20x78	1,453	179	240	30
	CA	E	24x60	1,330	135	225	24
	CA	F	24x66	1,391	135	230	28
	CA	G	24x72	1,453	135	235	30
	CA	H	24x78	1,517	179	245	32
Credenza Full Ped w/Hinged Doors							
	CF	A	20x60	1,865	135	250	24
	CF	B	20x66	1,929	135	258	26
	CF	C	20x72	1,997	135	268	28
	CF	D	20x78	2,059	179	280	30
	CF	E	24x60	1,929	135	258	26
	CF	F	24x66	1,997	135	268	28
	CF	G	24x72	2,059	135	280	30
	CF	H	24x78	2,190	179	292	32

TABLE OF CONTENTS

Configuration	Quick Model	Quick Size	Size	Pony	Carton	B-Weight	Cube
Knespace Credenza Personal Lateral							
	CPK	A	20x72	1,906	135	228	28
	CPK	B	20x78	1,969	179	238	30
	CPK	C	24x72	2,034	135	248	30
	CPK	D	24x78	2,098	179	258	32

RIGHT OR LEFT
Specify (RP) for Right Ped or (LP) for Left Ped on credenza w/single ped

Knespace Credenza Lateral File							
	CL	A	20x72	1,641	135	220	28
	CL	B	20x78	1,696	179	230	30
	CL	C	24x72	1,696	135	240	30
	CL	D	24x78	1,758	179	250	32

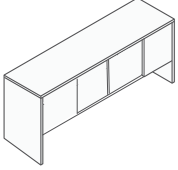
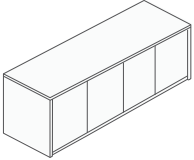
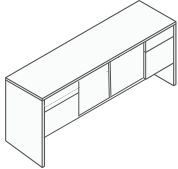
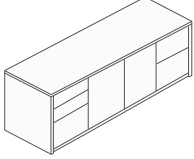
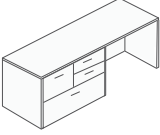
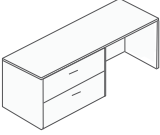
NOTE
Black pulls are standard where shown

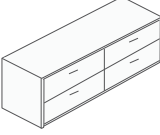
Credenza Double Lateral							
	CDL	A	20x72	2,097	135	340	28
	CDL	B	24x72	2,159	135	360	30

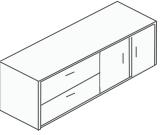
Credenza Lateral/Storage							
	CLS	A	20x72	2,074	135	306	28
	CLS	B	24x72	2,123	135	326	30

Credenza Personal Lateral/Storage							
	CPL	A	20x72	2,336	135	316	28
	CPL	B	24x72	2,398	135	336	30

TABLE OF CONTENTS

Configuration	Quick Model	Quick Size	Size	Pony	Carton	B-Weight	Cube
Buffet Credenza Full Hinged Doors							
	HDHD	A	20x72x36	2,248	182	230	30
	HDHD	B	24x72x36	2,341	182	250	36
	HDHD	C	20x78x36	2,429	218	270	33
	HDHD	D	24x78x36	2,521	218	290	39

NOTE
Black pulls are standard where shown

Buffet Credenza Hinged Doors & Drawers							
	BBHD	A	20x72x36	2,882	182	310	30
	BBHD	B	24x72x36	2,971	182	330	36
	BBHD	C	20x78x36	3,063	218	350	33
	BBHD	D	24x78x36	3,153	218	370	39

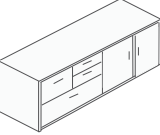
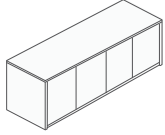
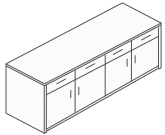
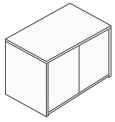
Credenza Hinged Door Storage							
	HD	A	20x36	882	101	180	13
	HD	B	24x36	945	101	190	15
	HD	C	20x36x36	1,060	126	201	15
	HD	D	24x36x36	1,123	126	211	18







Buffet Credenza Hinged Door Storage w/Drawers							
	BHD	A	20x36x36	1,197	112	220	15
	BHD	B	24x36x36	1,270	112	230	18

TABLE OF CONTENTS

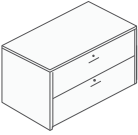
Configuration	Quick Model	Quick Size	Size	Pony	Carton	B-Weight	Cube
Lateral File 2 Drawer							
	LF	A	20x36	1,052	87	178	15
	LF	B	24x36	1,137	87	192	17
Lateral File 3 Drawer							
	LF3	A	20x36x42	1,735	140	240	17
	LF3	B	24x36x42	1,876	140	260	20
Lateral File 4 Drawer							
	LF4	A	20x36x54	2,313	186	300	22
	LF4	B	24x36x54	2,500	186	320	26
Personal Lateral File							
	PLF	A	20x36	1,330	87	188	15
	PLF	B	24x36	1,416	87	202	17
Vertical File 2 Drawer							
	VF	A	24x18	805	87	140	8
	VF	B	24x21	911	87	150	9
Vertical File 3 Drawer							
	VF3	A	24x18x42	1,326	140	200	11
	VF3	B	24x21x42	1,504	140	220	13
Vertical File 4 Drawer							
	VF4	A	24x18x54	1,767	186	260	15
	VF4	B	24x21x54	2,003	186	280	17

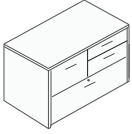
NOTE

High profile furniture should be anchored to the wall by licensed installers using own fasteners

One face lock for each drawer included on file drawers

OPTIONAL GANGLOCK

For 2 Drawer: Add \$109 list

For 3 Drawer: Add \$194 list

For 4 Drawer: Add \$279 list

VERTICAL FILE



A = Letter Size

B = Legal Size

PULLS

Black pulls are standard on lateral and vertical files

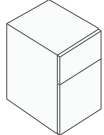
TABLE OF CONTENTS

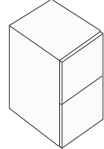
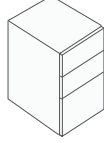
Configuration	Quick Model	Quick Size	Size	Price	Carton	B-Weight	Cube
Free-stand Pedestal Box/File							
	2D	PD	23X16X19.5	590	84	84	6
	2D	PCR	19X16X19.5	590	84	84	6
Free-stand Pedestal Box/Box/Box							
	3D	PD	23X16X19.5	695	97	90	6
	3D	PCR	19X16X19.5	695	97	90	6
Free-stand Pedestal Four Box Drawer							
	4D	PD	23X16X25.5	857	97	109	8
	4D	PCR	19X16X25.5	857	97	109	8
Free-stand Pedestal File/File							
	2H	PD	23X16X25.5	749	97	99	8
	2H	PCR	19X16X25.5	749	97	99	8
Free-stand Pedestal Box/Box/File							
	3H	PD	23X16X25.5	803	97	99	8
	3H	PCR	19X16X25.5	803	97	99	8

NOTE

Finished peds come with 3/4" top and square edges

All drawers come with ball-bearing suspensions





CASTERS or KICK BASE
Add \$61 list for casters or kick base

Pedestal becomes 2" higher

GANGLOCK or PED-LOCK

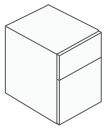
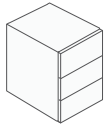
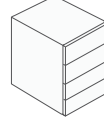
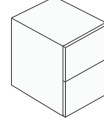
Add \$109 list

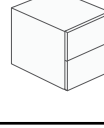
TABLE OF CONTENTS

Configuration	Quick Model	Quick Size	Size	Price	Carton	B-Weight	Cube
Pedestal Box/File							
	2D		23x16x18	322	84	75	4
Pedestal Box/Box/Box							
	3D		23x16x18	377	84	75	4
Pedestal Four Box Drawer							
	4D		23x16x24	645	97	100	6
Pedestal File/File							
	2H		23x16x24	537	97	90	6
Pedestal Box/Box/File							
	3H		23x16x24	537	97	90	6
Pedestal – Legal Size File/File							
	2LS		23x20x24	707	97	100	6
Pedestal Lateral File							
	LF		23x36x24	848	87	120	10

NOTE

Hanging pedestals are designed to customize your desk shell, desk, credenza, etc.

All peds are one side finished, unfinished top and back, and field installable

TABLE OF CONTENTS

WARDROBE

Configuration is applicable for 20x36x72 or higher

Use pricing from Full Hinged (BCW-F-3) and up

Smaller size DON'T have Bottom Shelf

For 24" Depth Laminate, add \$166 list
For 24" Veneer, add \$331 list

For Double Face Lock "Installed on top doors", add \$66 list

For Lock Mechanism "Centered Installed", add \$281 list

Black pulls standard where shown

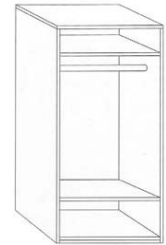

Centered (WD)
Add \$83 list

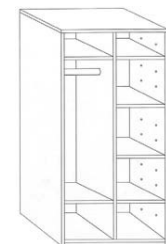

Left (WDL)
Add \$166 list

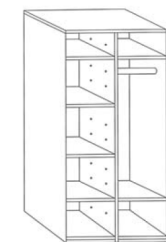

Right (WDR)
Add \$166 list

Configuration	Quick Model	Quick Size	Adj. Selves	Size	Pony	Carton	B-Weight	Cube
Bookcase								
	BC	A	1	12x36x29	378	116	72	11
	BC	B	1	12x36x36	426	116	90	14
	BC	C	2	12x36x42	475	116	100	16
	BC	D	2	12x36x48	507	116	110	18
	BC	E	3	12x36x60	574	116	140	22
	BC	F	3	12x36x66	625	116	150	24
	BC	G	4	12x36x72	679	116	170	26
	BC	H	4	12x36x78	723	116	182	28
	BC	I	5	12x36x84	772	116	200	30

Bookcase Hinged Doors								
	BCH	A	1	14x36x60	1,082	218	140	22
	BCH	B	1	14x36x66	1,181	218	155	24
	BCH	C	2	14x36x72	1,228	218	170	28
	BCH	D	2	14x36x78	1,280	218	185	30
	BCH	E	3	14x36x84	1,329	218	200	32
	BCH	F	1	20x36x60	1,403	218	177	25
	BCH	G	1	20x36x66	1,526	218	188	28
	BCH	H	2	20x36x72	1,601	218	203	30
	BCH	I	2	20x36x78	1,707	218	218	33
	BCH	J	3	20x36x84	1,749	218	233	35

Bookcase Full Hinged								
	BCW	A	3	14x36x60	1,688	218	185	22
	BCW	B	3	14x36x66	1,734	218	195	24
	BCW	C	4	14x36x72	1,784	218	220	26
	BCW	D	4	14x36x78	1,833	218	235	28
	BCW	E	5	14x36x84	1,883	218	255	30
	BCW	F	3	20x36x60	2,008	218	218	25
	BCW	G	3	20x36x66	2,080	218	228	28
	BCW	H	4	20x36x72	2,153	218	253	30
	BCW	I	4	20x36x78	2,229	218	268	33
	BCW	J	5	20x36x84	2,303	218	288	35

Bookcase Lateral File								
	BCL	A	1	20x36x60	2,102	218	275	28
	BCL	B	1	20x36x66	2,154	218	300	30
	BCL	C	2	20x36x72	2,202	218	330	32
	BCL	D	2	20x36x78	2,254	218	350	34
	BCL	E	3	20x36x84	2,302	218	370	38

Bookcase Hinged Doors/Lateral File								
	BC5	A	1	20x36x60	2,655	218	275	28
	BC5	B	1	20x36x66	2,706	218	300	30
	BC5	C	2	20x36x72	2,755	218	330	32
	BC5	D	2	20x36x78	2,805	218	350	34
	BC5	E	3	20x36x84	2,858	218	370	38

TABLE OF CONTENTS

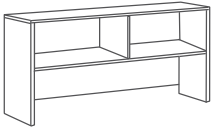
Configuration	Quick Model	Quick Size	Size	Pony	Carton	B-Weight	Cube
Hutch Open							
	H0	A	14x33x37	684	77	110	15
	H0	B	14x45x37	738	88	120	18
	H0	C	14x57x37	843	101	130	22
	H0	D	14x63x37	895	114	135	25
	H0	E	14x69x37	949	122	145	28
	H0	F	14x75x37	1,054	135	160	31

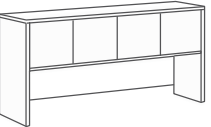
Hutch Hinged Doors							
	H1	A	14x33x37	843	77	120	15
	H1	B	14x45x37	949	88	130	18
	H1	C	14x57x37	1,054	101	140	22
	H1	D	14x63x37	1,108	114	145	25
	H1	E	14x69x37	1,157	122	155	28
	H1	F	14x75x37	1,263	135	170	31

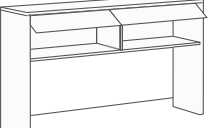
Hutch Garage Doors							
	H2	A	15x33x37	935	77	120	15
	H2	B	15x45x37	1,128	88	130	18
	H2	C	15x57x37	1,233	101	140	22
	H2	D	15x63x37	1,286	114	145	25
	H2	E	15x69x37	1,337	122	155	28
	H2	F	15x75x37	1,443	135	170	31

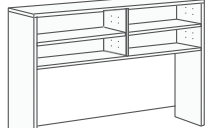
Hutch Open w/Adjustable Shelves							
	H3	A	14x33x42	787	77	115	16
	H3	B	14x45x42	839	88	125	19
	H3	C	14x57x42	945	101	135	23
	H3	D	14x63x42	996	114	150	27
	H3	E	14x69x42	1,051	122	165	31
	H3	F	14x75x42	1,154	135	140	34

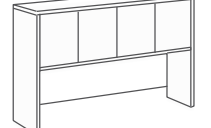
Hutch Hinged Doors w/Adjustable Shelves							
	H4	A	14x33x42	1,100	77	125	16
	H4	B	14x45x42	1,055	88	135	19
	H4	C	14x57x42	1,151	101	145	23
	H4	D	14x63x42	1,201	114	150	27
	H4	E	14x69x42	1,249	122	160	31
	H4	F	14x75x42	1,345	135	175	34

NOTE

High profile furniture should be anchored to the credenza or desk top with provided dowels or metal brackets

Hutches have 20" clearance from the fixed shelf to the work surface, and a 2" gap for wire management

TASK LIGHTS

23" Silver Metal: \$255 list

GLASS DOORS

Frosted Glass Doors (set of 2): \$331 list

Not available for H2 and H5 hutches

MAIL SORTER

Add \$182 list for mail sorter

Will reduce clearance from work surface by 5"

HINGED DOOR

H1A, H1B, H4A, and H4B come with 2 hinged doors; all others come with 4 hinged doors

GARAGE DOOR

H2A, H2B, H5A, and H5B come with 1 garage door; all others come with 2 garage doors

TACKBOARDS

See page #26 for tackboards

TABLE OF CONTENTS

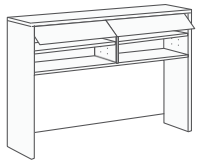
Configuration	Quick Model	Quick Size	Size	Pony	Carton	B-Weight	Cube
Hutch Garage Doors w/Adjustable Shelves							
	H5	A	15x33x42	1,282	77	125	16
	H5	B	15x45x42	1,334	88	135	19
	H5	C	15x57x42	1,441	101	145	23
	H5	D	15x63x42	1,493	114	150	27
	H5	E	15x69x42	1,545	122	160	31
	H5	F	15x75x42	1,649	135	175	34

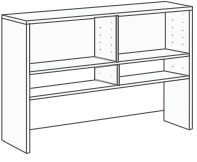
Hutch Open w/Adjustable Shelves							
	H6	A	14x33x49	886	77	120	18
	H6	B	14x45x49	962	88	130	21
	H6	C	14x57x49	1,112	101	140	24
	H6	D	14x63x49	1,187	114	145	28
	H6	E	14x69x49	1,261	122	155	32
	H6	F	14x75x49	1,370	135	170	36

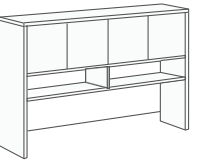
Hutch Hinged Doors w/Fixed Shelf							
	H7	A	14x33x49	1,207	77	130	18
	H7	B	14x45x49	1,282	88	140	21
	H7	C	14x57x49	1,433	101	150	24
	H7	D	14x63x49	1,508	114	155	28
	H7	E	14x69x49	1,583	122	165	32
	H7	F	14x75x49	1,692	135	180	36

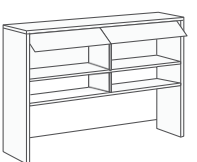
Hutch Garage Doors w/Fixed Shelf							
	H8	A	15x33x49	1,391	77	130	18
	H8	B	15x45x49	1,467	88	140	21
	H8	C	15x57x49	1,616	101	150	24
	H8	D	15x63x49	1,671	114	155	28
	H8	E	15x69x49	1,766	122	165	32
	H8	F	15x75x49	1,874	135	180	36

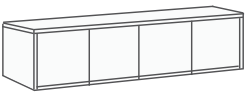
Wall-Mount Overhead							
	H9	A	15x36x15	956	86	62	5
	H9	B	15x48x15	1,148	100	84	7
	H9	C	15x60x15	1,434	111	106	8
	H9	D	15x66x15	1,530	120	117	9
	H9	E	15x72x15	1,626	132	128	10
	H9	F	15x78x15	1,913	142	140	11

NOTE

High profile furniture should be anchored to the credenza or desk top with provided dowels or metal brackets

Hutches have 20" clearance from the fixed shelf to the work surface, and a 2" gap for wire management

TASK LIGHTS

23" Silver Metal: \$255 list

GLASS DOORS

Frosted Glass Doors (set of 2): \$331 list

Not available for H8 hutch

MAIL SORTER

Add \$182 list for mail sorter

Will reduce clearance from work surface by 5"

HINGED DOOR

H7A, H7B, H9A, and H9B come with 2 hinged doors; all others come with 4 hinged doors

GARAGE DOOR

H8A, H8B, H9A, and H9B come with 1 garage door; all others come with 2 garage doors

TACKBOARDS

See page #26 for tackboards

WALL-MOUNT OVERHEAD

Licensed installers are recommended to install wall-mounted furniture. Installers must provide fasteners.

WALL-MOUNT OVERHEAD

Add \$339 list for garage doors

TABLE OF CONTENTS

LAMINATE W/WOOD EDGE

[Back to main Table of Contents](#)

Click text to jump page

SERIES

pg. 164	FLOW	 (W)	
pg. 164	ECHO	 (E)	Included in pricing: BEVELED, SQUARE, MATRIX
pg. 187	FLUTED-L	 (FL)	Included in pricing: SAGA-L
pg. 187	CONCORD-L	 (CL)	Included in pricing: VICTORY-L



BEVELED
(BL)



SQUARE
(QL)



MATRIX
(ML)



SAGA-L
(SL)

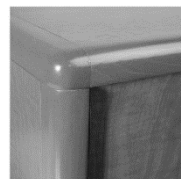

VICTORY-L
(VL)

TABLE OF CONTENTS

LAMINATE W/WOOD EDGE

FLOW & ECHO

TABLE OF CONTENTS

Click text to jump page





<i>pg. 165</i>	<u>DESKS</u>	
<i>pg. 169</i>	<u>DESK UNITS</u>	
<i>pg. 175</i>	<u>BRIDGES/RETURNS</u>	
<i>pg. 177</i>	<u>CREDENZAS</u>	
<i>pg. 181</i>	<u>FILES/STORAGE</u>	
<i>pg. 184</i>	<u>BOOKCASES</u>	
<i>pg. 185</i>	<u>HUTCHES</u>	

TABLE OF CONTENTS

Configuration	Quick Model	Quick Size	Size	Flow	Echo	Carton	B-Weight	Cube
Desk Shell No Ped ¾ Modesty – add \$79 for Full (FM)								
	S	A	24x48	707	1,008	101	102	24
	S	B	24x60	707	1,074	135	120	30
	S	C	24x66	901	1,201	135	125	32
	S	D	24x72	901	1,201	135	135	35
	S	E	30x48	815	1,074	135	120	28
	S	F	30x60	882	1,074	135	140	36
	S	G	30x66	944	1,137	135	148	35
	S	H	30x72	1,008	1,201	135	154	42
	S	I	36x72	1,116	1,287	135	180	50
	S	J	36x78	1,245	1,416	179	190	54

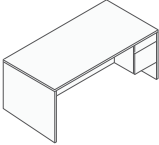
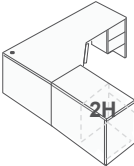
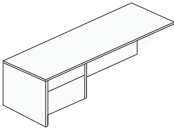
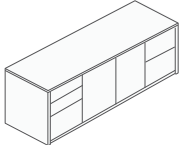
ECHO
Edges also included in pricing:
Beveled, Square,
Matrix

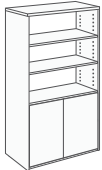
FAN TOP

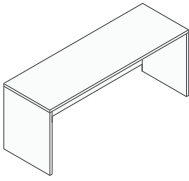

6" fan top (FT)

Flow: add \$364 list
Echo: add \$485 list

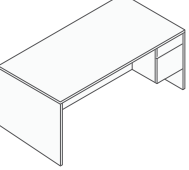
Desk Single ¾ Ped ¾ Modesty – add \$79 for Full (FM)								
	S3	A	24x48	1,004	1,268	101	150	24
	S3	B	30x48	1,074	1,330	101	170	24
	S3	C	30x60	1,138	1,330	135	185	28
	S3	D	30x66	1,201	1,394	179	195	30
	S3	E	30x72	1,268	1,456	101	205	24
	S3	F	36x72	1,394	1,550	135	230	30
	S3	G	36x78	1,502	1,674	179	240	32

RIGHT OR LEFT
Specify (RP) for Right Pedestal or
(LP) for Left Pedestal

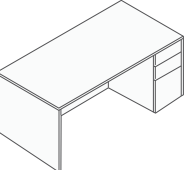
Desk Single Full Ped Full Modesty								
	FP	A	24x48	1,137	1,438	135	160	28
	FP	B	30x48	1,245	1,501	135	170	32
	FP	C	30x60	1,309	1,501	135	190	40
	FP	D	30x66	1,372	1,563	135	210	44
	FP	E	30x72	1,438	1,633	135	230	48
	FP	F	36x72	1,542	1,718	179	250	54
	FP	G	36x78	1,674	1,843	179	280	58

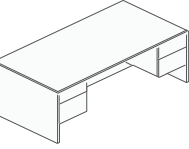
Desk Double ¾ Ped ¾ Modesty – add \$79 for Full (FM)								
	D3	A	30x60	1,394	1,586	135	232	36
	D3	B	30x66	1,456	1,652	135	242	40
	D3	C	30x72	1,523	1,718	135	250	44
	D3	D	36x72	1,633	1,803	135	270	50
	D3	E	36x78	1,758	1,928	179	285	54

Desk Double Full Ped Full Modesty								
	DF	A	30x60	1,739	1,928	135	290	36
	DF	B	30x66	1,803	1,996	135	300	40
	DF	C	30x72	1,865	2,059	135	310	42
	DF	D	36x72	1,975	2,144	135	330	50
	DF	E	36x78	2,105	2,274	179	340	54

TABLE OF CONTENTS

Configuration	Quick Model	Quick Size	Size	Flow	Echo	Carton	B-Weight	Cube
Computer Desk Corner Table								
	CCT	A	20-30x30	873	916	135	80	20
	CCT	B	20-36x36	981	1,025	135	100	25
	CCT	C	20-42x42	1,089	1,130	135	124	35
	CCT	D	20-48x48	1,195	1,239	135	150	45
	CCT	E	24-36x36	1,239	1,280	135	110	30
	CCT	F	24-42x42	1,345	1,390	135	120	35
	CCT	G	24-48x48	1,452	1,502	135	155	42

ECHO
Edges also included in pricing:
Beveled, Square,
Matrix

FAN TOP

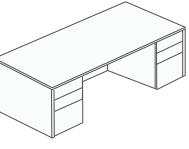
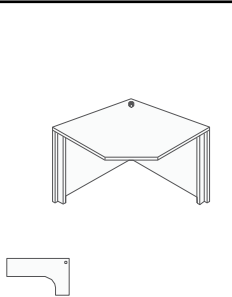
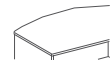

6" fan top (FT)

Flow: add \$364 list
Echo: add \$485 list

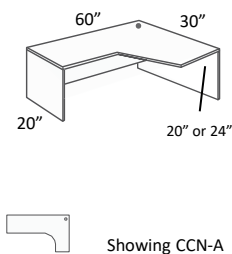
Computer Desk No Ped ¾ Modesty – add \$79 for Full (FM)								
	CCN	A	20-60x30	1,030	1,201	135	184	36
	CCN	B	20-66x30	1,074	1,245	135	192	40
	CCN	C	20-72x30	1,116	1,288	135	210	44
	CCN	D	20-78x30	1,157	1,330	179	230	60
	CCN	E	24-66x36	1,157	1,372	135	200	46
	CCN	F	24-72x36	1,201	1,417	135	210	50
	CCN	G	24-78x36	1,245	1,458	179	230	60
	CCN	H	30-66x42	1,330	1,585	135	250	54
	CCN	I	30-72x42	1,394	1,653	135	260	60
	CCN	J	30-78x42	1,458	1,719	179	272	64
	CCN	K	36-72x48	1,586	1,889	135	285	68
	CCN	L	36-78x48	1,674	1,975	179	300	70

RADIAL CORNER



Radial corner (RC)

Flow: add \$158 list
Echo: add \$206 list

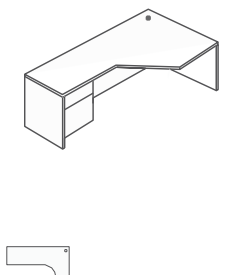
Computer Desk ¾ Ped ¾ Modesty – add \$79 for Full (FM)								
	CCS	A	20-60x30	1,288	1,456	135	220	36
	CCS	B	20-66x30	1,330	1,502	135	230	40
	CCS	C	20-72x30	1,372	1,544	135	242	42
	CCS	D	20-78x30	1,417	1,586	179	260	46
	CCS	E	24-66x36	1,417	1,633	135	230	46
	CCS	F	24-72x36	1,458	1,719	135	250	52
	CCS	G	24-78x36	1,502	1,758	179	260	56
	CCS	H	30-66x42	1,585	1,889	135	250	52
	CCS	I	30-72x42	1,653	1,954	135	260	56
	CCS	J	30-78x42	1,719	2,018	179	275	60
	CCS	K	36-72x48	1,844	2,190	135	275	60
	CCS	L	36-78x48	1,929	2,276	179	285	64

RIGHT OR LEFT
Specify (RP) for Right Pedestal or
(LP) for Left Pedestal

NOTE

Black grommet standard

TABLE OF CONTENTS

Configuration	Quick Model	Quick Size	Size	Flow	Echo	Carton	B-Weight	Cube
Computer Desk Full Ped Full Modesty								
	CDF	A	20-60x30	1,456	1,633	135	190	36
	CDF	B	20-66x30	1,502	1,675	135	200	40
	CDF	C	20-72x30	1,544	1,719	135	225	50
	CDF	D	20-78x30	1,586	1,758	179	235	54
	CDF	E	24-66x36	1,586	1,804	135	245	46
	CDF	F	24-72x36	1,633	1,889	135	255	50
	CDF	G	24-78x36	1,674	1,929	179	265	54
	CDF	H	30-66x42	1,758	2,059	135	265	54
	CDF	I	30-72x42	1,824	2,123	135	275	60
	CDF	J	30-78x42	1,889	2,190	179	285	64
	CDF	K	36-72x48	2,018	2,360	135	300	68
	CDF	L	36-78x48	2,102	2,445	179	320	72

ECHO
Edges also included in pricing:
Beveled, Square,
Matrix

FAN TOP

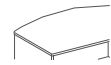

6" fan top (FT)

Flow: add \$364 list
Echo: add \$485 list

Computer Desk Lateral File w/Black Pulls Full Modesty								
	DL	A	20-72x30	2,037	2,208	135	230	44
	DL	B	20-78x30	2,082	2,251	179	240	48
	DL	C	24-72x36	2,123	2,340	135	255	50
	DL	D	24-78x36	2,166	2,381	179	265	54
	DL	E	30-72x42	2,316	2,574	135	265	60
	DL	F	30-78x42	2,381	2,639	179	305	64
	DL	G	36-72x48	2,509	2,811	135	320	68
	DL	H	36-78x48	2,594	2,896	179	340	72

RADIAL CORNER



Radial corner (RC)

Flow: add \$166 list
Echo: add \$206 list

Computer Desk Personal Lateral File w/Black Pulls Full Modesty								
	CP	A	20-72x30	2,316	2,486	135	238	44
	CP	B	20-78x30	2,360	2,530	179	248	48
	CP	C	24-72x36	2,401	2,615	135	273	50
	CP	D	24-78x36	2,445	2,660	179	263	54
	CP	E	30-72x42	2,594	2,854	135	293	60
	CP	F	30-78x42	2,660	2,917	179	313	64
	CP	G	36-72x48	2,789	3,090	135	328	68
	CP	H	36-78x48	2,874	3,175	179	348	72

RIGHT OR LEFT
Specify (RP) for Right Pedestal or
(LP) for Left Pedestal

NOTE
Black grommet standard

TABLE OF CONTENTS

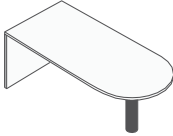
Configuration	Quick Model	Quick Size	Size	Flow	Echo	Carton	B-Weight	Cube
Bullet Desk No Ped ¾ Modesty – add \$79 for Full (FM)								
	BN	A	30x60	1,309	1,478	116	130	36
	BN	B	30x66	1,438	1,611	116	154	42
	BN	C	30x72	1,438	1,611	116	145	43
	BN	D	36x72	1,544	1,719	116	165	50
	BN	E	36x78	1,758	1,929	153	200	64
	BN	F	42x84	1,975	2,144	153	220	68

ECHO
Edges also included in pricing:
Beveled, Square,
Matrix

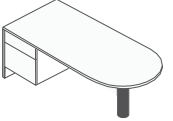
Bullet Desk ¾ Ped ¾ Modesty – add \$79 for Full (FM)								
	BS	A	30x60	1,563	1,739	116	235	42
	BS	B	30x66	1,696	1,865	116	235	42
	BS	C	30x72	1,696	1,865	116	245	50
	BS	D	36x72	1,804	1,975	153	265	54
	BS	E	36x78	2,018	2,190	153	275	64
	BS	F	42x84	2,230	2,401	153	285	68

NOTE
BN model not intended for sale as
free standing desk. See bridges
and returns.

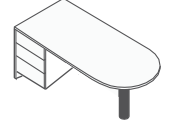
Bullet Desk Full Ped Full Modesty								
	BF	A	30x60	1,695	1,864	116	230	38
	BF	B	30x66	1,822	1,996	116	240	40
	BF	C	30x72	1,822	1,996	116	250	40
	BF	D	36x72	1,928	2,101	116	265	42
	BF	E	36x78	2,143	2,315	153	275	46
	BF	F	42x84	2,359	2,529	153	310	50

POST
Standard in black

Available in silver, add \$32 list

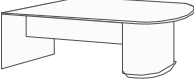
Bullet Desk ½ Cylinder Desk No Ped add \$79 for Full Modesty (FM)								
	BCN	A	30x60	1,844	2,018	116	255	42
	BCN	B	30x66	1,975	2,144	116	270	44
	BCN	C	30x72	1,975	2,144	116	270	44
	BCN	D	36x72	2,082	2,251	116	285	48
	BCN	E	36x78	2,295	2,466	153	310	60
	BCN	F	42x84	2,509	2,681	153	330	64

RIGHT OR LEFT
Specify (RP) for Right Pedestal or
(LP) for Left Pedestal

Bullet Desk ¾ Ped ¾ Modesty – add \$79 for Full (FM)								
	BCS	A	30x60	2,102	2,276	116	260	40
	BCS	B	30x66	2,230	2,401	116	280	42
	BCS	C	30x72	2,230	2,401	116	300	44
	BCS	D	36x72	2,340	2,509	116	320	44
	BCS	E	36x78	2,551	2,726	153	340	52
	BCS	F	42x84	2,768	2,939	153	350	64





Bullet Desk Full Ped Full Modesty								
	BCF	A	30x60	2,230	2,401	116	270	42
	BCF	B	30x66	2,360	2,530	116	270	44
	BCF	C	30x72	2,360	2,530	116	310	46
	BCF	D	36x72	2,466	2,639	116	320	48
	BCF	E	36x78	2,681	2,854	153	340	54
	BCF	F	42x84	2,896	3,067	153	360	64

TABLE OF CONTENTS

Configuration	Quick Model	Quick Size	Size	Flow	Echo	Carton	B-Weight	Cube
L-Shaped Desk ¾ Ped ¾ Modesty – add \$158 for Full (FM)								
	D	1	30x66 Desk 24x42 Return	2,144	2,593	240	300	64
	D	2	36x72 Desk 24x48 Return	2,360	3,638	240	355	75
L-Shaped Desk Full Ped Full Modesty								
	D	3	36x72 Desk 24x48 Return	2,703	3,196	240	410	75
L-Shaped Computer Desk ¾ Ped ¾ Modesty – add \$158 for Full (FM)								
 	D	4	36-72x48 Desk 24x48 Return	2,832	3,390	291	340	75
L-Shaped Computer Desk Full Ped Full Modesty								
 	D	5	36-72x48 Desk 24x48 Return	3,174	3,798	291	367	75

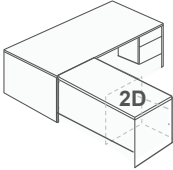
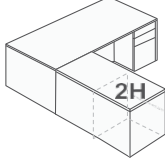
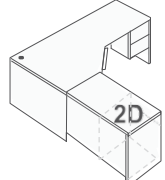
ECHO

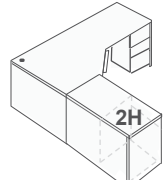
Edges also included in pricing:
Beveled, Square,
Matrix

FAN TOP

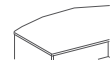

6" fan top (FT)

Flow: add \$364 list
Echo: add \$485 list

RADIAL CORNER



Radial corner (RC)

Flow: add \$166 list
Echo: add \$206 list

RIGHT OR LEFT

Specify (R) for Right Return or
(L) for Left Return

NOTE

Black grommet are standard on
Computer Desk

TABLE OF CONTENTS

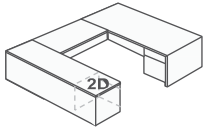
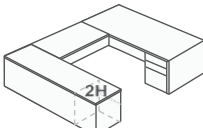
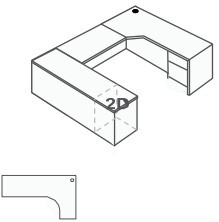
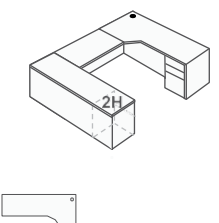
Configuration	Quick Model	Quick Size	Size	Flow	Echo	Carton	B-Weight	Cube
U-Shaped Desk ¾ Ped ¾ Modesty – add \$158 for Full (FM)								
	D	6	36X72 Desk 24x48 Bridge 24x72 Credenza	3,281	3,925	330	455	98
U-Shaped Desk Full Ped Full Modesty								
	D	7	36X72 Desk 24x48 Bridge 24x72 Credenza	3,458	4,075	300	580	115
U-Shaped Computer Desk ¾ Ped ¾ Modesty – add \$158 for Full (FM)								
	D	8	30-72x42 Desk 24x48 Bridge 24x72 Credenza	3,689	4,739	330	455	98
U-Shaped Computer Desk Full Ped Full Modesty								
	D	9	30-72x42 Desk 24x48 Bridge 24x72 Credenza	4,034	4,589	330	580	115

ECHO

Edges also included in pricing:
Beveled, Square,
Matrix

FAN TOP



6" fan top (FT)

Flow: add \$364 list
Echo: add \$485 list

RADIAL CORNER



Radial corner (RC)

Flow: add \$166 list
Echo: add \$206 list

RIGHT OR LEFT

Specify (R) for Right Bridge or
(L) for Left Bridge

NOTE

Black grommet are standard on
Computer Desk

TABLE OF CONTENTS

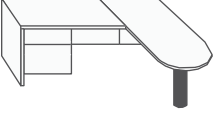
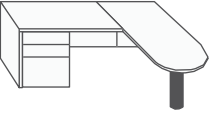
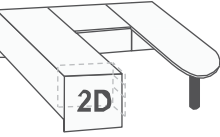
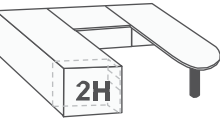
Configuration	Quick Model	Quick Size	Size	Flow	Echo	Carton	B-Weight	Cube
L-Shaped Bullet Desk ¾ Ped ¾ Modesty – add \$158 for Full (FM)								
	D	10	36X72 Desk 24x48 Return	2,530	2,959	214	290	68
L-Shaped Bullet Desk Full Ped Full Modesty								
	D	11	36X72 Desk 24x48 Return	2,704	3,197	214	315	72
U-Shaped Bullet Desk ¾ Ped ¾ Modesty – add \$158 for Full (FM)								
	D	12	36x72 Desk 24x48 Bridge 24x72 Credenza	3,346	4,098	330	555	96
U-Shaped Bullet Desk Full Ped Full Modesty								
	D	13	36x72 Desk 24x48 Bridge 24x72 Credenza	4,054	4,694	330	583	96

ECHO

Edges also included in pricing:
Beveled, Square,
Matrix

POST

Standard in black

Available in silver, add \$32 list

RIGHT OR LEFT

Specify (R) for Right Bridge or (L)
for Left Bridge

TABLE OF CONTENTS

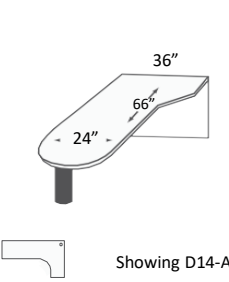
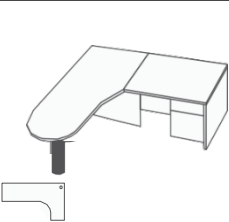
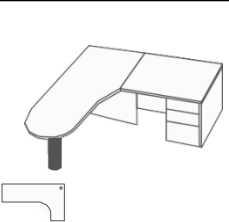
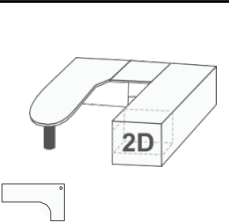
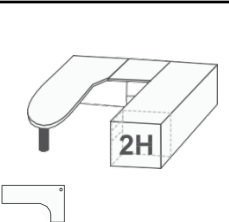
Configuration	Quick Model	Quick Size	Size	Flow	Echo	Carton	B-Weight	Cube
Bullet Computer Desk Shell ¾ Modesty – add \$79 for Full (FM)								
 <p>Showing D14-A</p>	D14	A	24-66X36	1,416	1,899	116	125	42
	D14	B	24-72X36	1,501	2,003	116	135	45
	D14	C	24-78X36	1,586	2,111	153	145	48
	D14	D	30-66X42	1,652	2,220	116	145	51
	D14	E	30-72X42	1,739	2,328	116	155	54
	D14	F	30-78X42	1,824	2,437	153	165	57
	D14	G	36-66X48	1,887	2,541	116	165	60
	D14	H	36-72X48	2,037	2,648	116	175	63
	D14	I	36-78X48	2,059	2,755	153	185	66
L-Shaped Bullet Computer Desk ¾ Ped ¾ Modesty – add \$158 for Full (FM)								
	D	15	30-72x42 Desk 24x48 Return	2,725	3,572	214	255	78
L-Shaped Bullet Computer Desk Full Ped Full Modesty								
	D	16	30-72x42 Desk 24x48 Return	2,895	3,807	214	285	78
U-Shaped Bullet Computer Desk ¾ Ped ¾ Modesty – add \$158 for Full (FM)								
	D	17	30-72x42 Desk 24x42 Bridge 24x72 Credenza	3,602	4,666	351	465	106
U-Shaped Bullet Computer Desk Full Ped Full Modesty								
	D	18	30-72x42 Desk 24x42 Bridge 24x72 Credenza	3,776	4,836	351	495	106

ECHO

Edges also included in pricing:
Beveled, Square,
Matrix

NOTE

D14 model not intended for sale
as freestanding desk. See bridges
and returns.

RADIAL CORNER

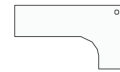

Radial corner (RC)

Flow: add \$158 list
Echo: add \$206 list

POST

Standard in black

Available in silver, add \$32 list

RIGHT OR LEFT

Specify (R) for Right Bridge or (L)
for Left Bridge

TABLE OF CONTENTS

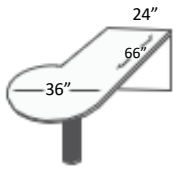
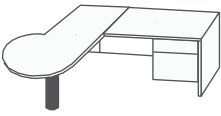
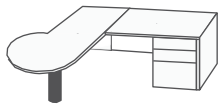
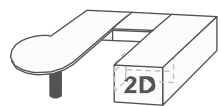
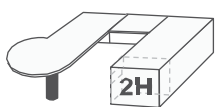
Configuration	Quick Model	Quick Size	Size	Flow	Echo	Carton	B-Weight	Cube
P-Shaped Desk Shell ¾ Modesty – add \$79 for Full (FM)								
 <p>Showing D19-A</p>	D19	A	36-66x24	1,501	2,229	116	105	42
	D19	B	36-72x24	1,563	2,360	123	120	45
	D19	C	36-78x24	1,633	2,486	136	135	49
	D19	D	42-66x30	1,781	2,508	123	150	48
	D19	E	42-72x30	1,843	2,639	136	165	53
	D19	F	42-78x30	1,911	2,767	143	180	57
	D19	G	48-66x36	1,996	2,725	136	195	55
	D19	H	48-72x36	2,059	2,853	143	210	60
	D19	I	48-78x36	2,122	2,982	153	225	66
L-Shaped P-Desk ¾ Ped ¾ Modesty – add \$158 for Full (FM)								
	D	20	48-78x36 Desk 24x48 Return	3,111	4,224	256	285	86
L-Shaped P-Desk Full Ped Full Modesty								
	D	21	48-78x36 Desk 24x48 Return	3,281	4,460	256	298	86
U-Shaped P-Desk ¾ Ped ¾ Modesty – add \$158 for Full (FM)								
	D	22	48-78x36 Desk 24x48 Bridge 24x78 Credenza	4,034	5,360	384	508	119
U-Shaped P-Desk Full Ped Full Modesty								
	D	23	48-78x36 Desk 24x48 Bridge 24x78 Credenza	4,633	5,962	384	538	119

ECHO

Edges also included in pricing:
Beveled, Square,
Matrix

NOTE

D19 model not intended for sale
as freestanding desk. See bridges
and returns.

POST

Standard in black

Available in silver, add \$32 list

RIGHT OR LEFT

Specify (R) for Right Bridge or (L)
for Left Bridge

TABLE OF CONTENTS

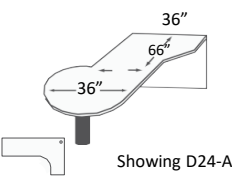
Configuration	Quick Model	Quick Size	Size	Flow	Echo	Carton	B-Weight	Cube
P-Shaped Computer Desk Shell ¾ Modesty – add \$79 for Full (FM)								
	D24	A	36-66x36	2,208	2,938	97	80	80
	D24	B	36-72x36	2,274	3,067	129	106	106
	D24	C	36-78x36	2,338	3,196	129	106	106
	D24	D	42-66x42	2,369	3,096	129	106	106
	D24	E	42-72x42	2,437	3,228	129	106	106
	D24	F	42-78x42	2,499	3,357	129	106	106

ECHO

Edges also included in pricing:
Beveled, Square,
Matrix

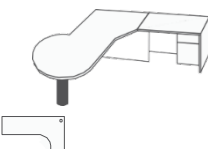
P-Shaped Computer Desk ¾ Ped ¾ Modesty – add \$158 for Full (FM)								
	D	25	36-78x36 Desk 24x48 Return	3,325	4,440	256	285	86

NOTE

D24 model not intended for sale as freestanding desk. See bridges and returns.

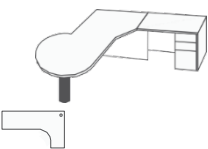
P-Shaped Computer Desk Full Ped Full Modesty								
	D	26	36-78x36 Desk 24x48 Return	3,496	4,610	256	298	86

RADIAL CORNER

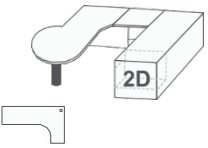

Radial corner (RC)
Flow: add \$158 list
Echo: add \$206 list

U-Shaped P-Desk ¾ Ped ¾ Modesty – add \$158 for Full (FM)								
	D	27	36-78x36 Desk 24x48 Bridge 24x78 Credenza	4,354	5,682	384	508	119

POST

Standard in black

Available in silver, add \$32 list

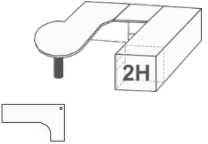
U-Shaped P-Desk Full Ped Full Modesty								
	D	28	36-78x36 Desk 24x48 Bridge 24x78 Credenza	4,525	6,027	384	538	119

RIGHT OR LEFT

Specify (R) for Right Bridge or (L) for Left Bridge

TABLE OF CONTENTS

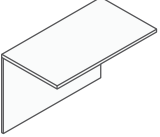
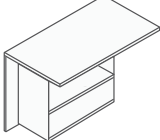
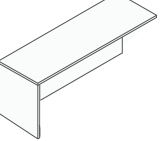
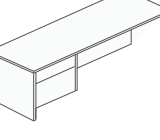
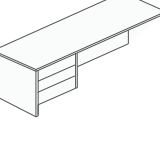
Configuration	Quick Model	Quick Size	Size	Flow	Echo	Carton	B-Weight	Cube
Bridge ¼ Mod w/2D Desk or Credenza Full Mod w/3H Desk or Credenza								
	B	A	20x36	540	750	101	55	15
	B	B	20x42	581	786	101	60	17
	B	C	20x48	623	832	101	65	19
	B	D	20x54	666	828	101	70	21
	B	E	24x36	583	832	101	60	18
	B	F	24x42	621	869	101	65	21
	B	G	24x48	666	914	101	70	24
	B	H	24x54	706	950	101	75	27
Bridge 12" Deep Bookcase								
	1BB	A	20x36	953	1,159	101	90	15
	1BB	B	20x42	993	1,200	101	95	17
	1BB	C	20x48	1,035	1,240	101	100	19
	1BB	D	20x54	1,076	1,284	101	105	21
	1BB	E	24x36	996	1,240	101	100	18
	1BB	F	24x42	1,034	1,282	101	105	21
	1BB	G	24x48	1,076	1,324	101	115	24
	1BB	H	24x54	1,119	1,367	101	125	27
Return Shell ¼ modesty – add \$79 for Full (FM)								
	R	A	20x36	581	786	101	55	15
	R	B	20x42	621	828	101	60	17
	R	C	20x48	664	870	101	65	19
	R	D	20x54	703	912	101	70	21
	R	E	24x36	622	870	101	75	18
	R	F	24x42	663	911	101	85	21
	R	G	24x48	703	953	101	60	24
	R	H	24x54	747	996	101	65	27
Return ¼ Ped (Box/File) ¼ modesty – add \$79 for Full (FM)								
	R2	A	20x36	829	1,035	101	75	15
	R2	B	20x42	869	1,076	101	80	17
	R2	C	20x48	912	1,119	101	85	19
	R2	D	20x54	953	1,159	101	90	21
	R2	E	24x36	870	1,119	101	80	18
	R2	F	24x42	911	1,157	101	85	21
	R2	G	24x48	953	1,202	101	100	24
	R2	H	24x54	996	1,240	101	115	27
Return ¼ Ped (Box/Box/Box) ¼ modesty – add \$79 for Full (FM)								
	R3	A	20x36	917	1,126	101	75	15
	R3	B	20x42	958	1,166	101	80	17
	R3	C	20x48	996	1,212	101	85	19
	R3	D	20x54	1,039	1,251	101	90	21
	R3	E	24x36	955	1,212	101	80	17
	R3	F	24x42	998	1,248	101	85	19
	R3	G	24x48	1,039	1,297	101	100	24
	R3	H	24x54	1,084	1,338	101	115	27

ECHO
Edges also included in pricing:
Beveled, Square,
Matrix

RIGHT OR LEFT
Specify (R) for Right or (L) for
Left

TABLE OF CONTENTS

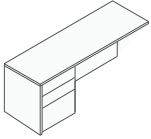
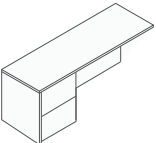
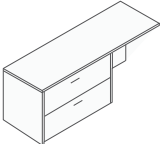
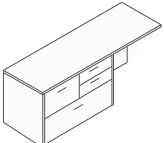
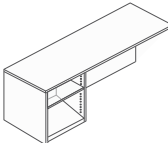
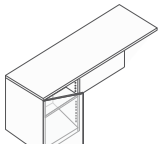
Configuration	Quick Model	Quick Size	Size	Flow	Echo	Carton	B-Weight	Cube
Return Full Ped (Box/Box/File) Full Modesty								
	RF	A	20x36	1,032	1,299	101	105	15
	RF	B	20x42	1,072	1,343	101	115	17
	RF	C	20x48	1,115	1,390	101	125	19
	RF	D	20x54	1,155	1,432	101	135	21
	RF	E	24x36	1,069	1,383	101	140	18
	RF	F	24x42	998	1,423	101	150	24
	RF	G	24x48	1,155	1,465	101	155	24
	RF	H	24x54	1,196	1,510	101	160	27
Return Full Ped (File/File) Full Modesty								
	RL	A	20x36	1,032	1,238	101	105	15
	RL	B	20x42	1,072	1,392	101	115	17
	RL	C	20x48	1,104	1,321	101	125	19
	RL	D	20x54	1,149	1,358	101	135	21
	RL	E	24x36	1,063	1,317	101	140	18
	RL	F	24x42	1,115	1,360	101	150	21
	RL	G	24x48	1,149	1,465	101	155	24
	RL	H	24x54	1,196	1,443	101	160	27
Return Lateral File w/Standard Black Pulls Full Modesty								
	RLF	A	20x48	1,590	1,796	101	175	19
	RLF	B	20x54	1,628	1,839	101	180	21
	RLF	C	20x60	1,670	1,882	101	185	24
	RLF	D	24x48	1,628	1,882	101	180	24
	RLF	E	24x54	1,670	1,923	101	185	27
	RLF	F	24x60	1,713	1,965	101	190	29
Return Personal Lateral File w/Standard Black Pulls Full Modesty								
	PF	A	20x48	1,832	2,045	101	184	19
	PF	B	20x54	1,878	2,086	101	189	21
	PF	C	20x60	1,919	2,129	101	194	24
	PF	D	24x48	1,878	2,129	101	184	24
	PF	E	24x54	1,919	2,170	101	189	27
	PF	F	24x60	1,961	2,212	101	194	30
Return Personal Printer w/Adjustable Shelf Full Modesty								
	PP	A	20x48	1,096	1,306	101	92	19
	PP	B	20x54	1,138	1,348	101	102	21
	PP	C	20x60	1,180	1,391	101	112	24
	PP	D	24x48	1,138	1,391	101	122	24
	PP	E	24x54	1,180	1,432	101	132	27
	PP	F	24x60	1,223	1,475	101	142	30
Return Personal Printer w/Door Full Modesty								
	PPD	A	20x48	1,293	1,504	101	92	19
	PPD	B	20x54	1,334	1,545	101	102	21
	PPD	C	20x60	1,377	1,588	101	112	24
	PPD	D	24x48	1,334	1,588	101	122	24
	PPD	E	24x54	1,377	1,628	101	132	27
	PPD	F	24x60	1,420	1,671	101	142	30

ECHO
Edges also included in pricing:
Beveled, Square,
Matrix

RIGHT OR LEFT
Specify (R) for Right or (L) for
Left

PULLS
Black pulls are standard on
Lateral Files

TABLE OF CONTENTS

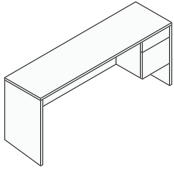
Configuration	Quick Model	Quick Size	Size	Flow	Echo	Carton	B-Weight	Cube
Kneespace Credenza ¼ Ped ¾ modesty – add \$79 for Full (FM)								
	C3	A	20x60	969	1,157	135	175	22
	C3	B	20x66	1,033	1,223	135	180	26
	C3	C	20x72	1,096	1,286	135	185	28
	C3	D	20x78	1,157	1,348	179	190	30
	C3	E	24x60	1,074	1,286	135	180	26
	C3	F	24x66	1,138	1,348	135	185	28
	C3	G	24x72	1,201	1,413	135	190	30
	C3	H	24x78	1,306	1,517	179	200	32

ECHO
Edges also included in pricing:
Beveled, Square,
Matrix

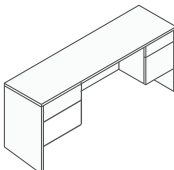
Configuration	Quick Model	Quick Size	Size	Flow	Echo	Carton	B-Weight	Cube
Kneespace Credenza Double ¼ Ped ¾ modesty – add \$79 for Full (FM)								
	CK	A	20x60	1,287	1,478	116	195	24
	CK	B	20x66	1,353	1,544	116	205	26
	CK	C	20x72	1,417	1,611	116	215	28
	CK	D	20x78	1,478	1,674	153	225	30
	CK	E	24x60	1,394	1,586	116	205	26
	CK	F	24x66	1,458	1,653	116	215	28
	CK	G	24x72	1,523	1,719	116	225	30
	CK	H	24x78	1,586	1,781	153	235	32

RIGHT OR LEFT
Specify (R) for Right Ped or Left
(L) or Left Ped on credenza
w/single ped

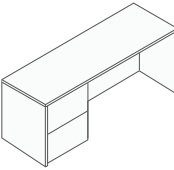
Configuration	Quick Model	Quick Size	Size	Flow	Echo	Carton	B-Weight	Cube
Kneespace Credenza Full Ped (File/File) Full Modesty								
	CSP	A	20x60	1,138	1,330	116	182	22
	CSP	B	20x66	1,201	1,391	116	192	26
	CSP	C	20x72	1,265	1,453	116	202	28
	CSP	D	20x78	1,330	1,517	153	212	30
	CSP	E	24x60	1,201	1,391	116	187	26
	CSP	F	24x66	1,265	1,453	116	192	28
	CSP	G	24x72	1,369	1,583	116	222	30
	CSP	H	24x78	1,475	1,688	153	232	32

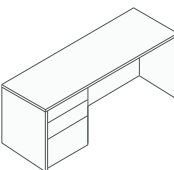
Configuration	Quick Model	Quick Size	Size	Flow	Echo	Carton	B-Weight	Cube
Kneespace Credenza Full Ped (Box/Box/File) Full Modesty								
	CS3	A	20x60	1,138	1,330	116	182	22
	CS3	B	20x66	1,201	1,391	116	192	26
	CS3	C	20x72	1,265	1,453	116	202	28
	CS3	D	20x78	1,330	1,517	153	212	30
	CS3	E	24x60	1,201	1,391	116	187	26
	CS3	F	24x66	1,265	1,453	116	192	28
	CS3	G	24x72	1,369	1,583	116	222	30
	CS3	H	24x78	1,475	1,688	153	232	32

Configuration	Quick Model	Quick Size	Size	Flow	Echo	Carton	B-Weight	Cube
Kneespace Credenza Double Full Ped Full Modesty								
	CN	A	20x60	1,633	1,824	116	185	24
	CN	B	20x66	1,696	1,889	116	190	26
	CN	C	20x72	1,758	1,954	116	198	28
	CN	D	20x78	1,824	2,018	153	210	30
	CN	E	24x60	1,739	1,929	116	190	26
	CN	F	24x66	1,804	1,997	116	198	28
	CN	G	24x72	1,865	2,059	116	210	30
	CN	H	24x78	1,929	2,123	153	220	32

TABLE OF CONTENTS

Configuration	Quick Model	Quick Size	Size	Flow	Echo	Carton	B-Weight	Cube
Credenza ¾ Storage w/Hinged Doors ¾ modesty – add \$79 for Full (FM)								
	CS	A	20x60	1,309	1,502	116	175	22
	CS	B	20x66	1,372	1,563	116	180	26
	CS	C	20x72	1,438	1,633	116	185	28
	CS	D	20x78	1,502	1,696	153	190	30
	CS	E	24x60	1,417	1,611	116	180	26?
	CS	F	24x66	1,912	2,102	116	185	28
	CS	G	24x72	1,544	1,739	116	190	30
	CS	H	24x78	1,611	1,804	153	200	32

ECHO
Edges also included in pricing:
Beveled, Square,
Matrix

Credenza Full Storage w/Hinged Doors Full Modesty								
	CT	A	20x60	1,841	2,034	116	185	24
	CT	B	20x66	1,906	2,098	116	190	26
	CT	C	20x72	1,968	2,163	116	195	28
	CT	D	20x78	2,034	2,227	153	200	30
	CT	E	24x60	1,948	2,142	116	190	26
	CT	F	24x66	2,013	2,204	116	195	28
	CT	G	24x72	2,077	2,269	116	200	30
	CT	H	24x78	2,142	2,333	153	205	32

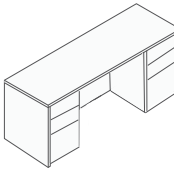
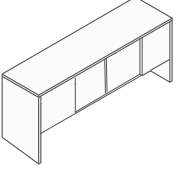
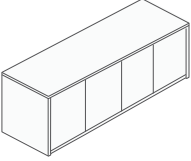
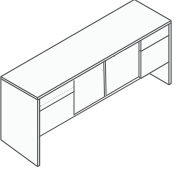
Credenza ¾ Ped w/Hinged Doors ¾ modesty – add \$79 for Full (FM)								
	CA	A	20x60	1,347	1,536	116	220	24
	CA	B	20x66	1,413	1,604	116	225	26
	CA	C	20x72	1,474	1,665	116	230	28
	CA	D	20x78	1,536	1,727	153	240	30
	CA	E	24x60	1,453	1,637	116	225	24
	CA	F	24x66	1,517	1,709	116	230	28
	CA	G	24x72	1,581	1,771	116	235	30
	CA	H	24x78	1,645	1,832	153	245	32

Credenza Full Ped w/Hinged Doors Full Modesty								
	CF	A	20x60	1,954	2,144	116	250	24
	CF	B	20x66	2,018	2,208	116	258	26
	CF	C	20x72	2,082	2,276	116	268	28
	CF	D	20x78	2,144	2,340	153	280	30
	CF	E	24x60	2,059	2,251	116	258	26
	CF	F	24x66	2,123	2,316	116	268	28
	CF	G	24x72	2,190	2,381	116	280	30
	CF	H	24x78	2,316	2,509	153	292	32

TABLE OF CONTENTS

Configuration	Quick Model	Quick Size	Size	Flow	Echo	Carton	B-Weight	Cube
Knespace Credenza Personal Lateral								
	CPK	A	20x72	1,991	2,183	135	228	28
	CPK	B	20x78	2,054	2,246	179	238	30
	CPK	C	24x72	2,161	2,376	135	248	30
	CPK	D	24x78	2,224	2,439	179	258	32

ECHO
Edges also included in pricing:
Beveled, Square,
Matrix

Knespace Credenza Lateral File								
	CL	A	20x72	1,719	1,912	135	220	28
	CL	B	20x78	1,781	1,975	179	230	30
	CL	C	24x72	1,824	2,039	135	240	30
	CL	D	24x78	1,889	2,102	179	250	32

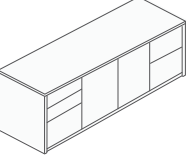
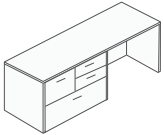
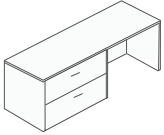
RIGHT OR LEFT
Specify (RP) for Right Ped or
(LP) for Left Ped on credenza
w/single ped

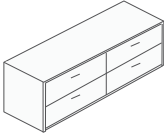
Credenza Double Lateral								
	CDL	A	20x72	2,182	2,371	135	340	28
	CDL	B	24x72	2,289	2,496	135	360	30

NOTE
Black pulls are standard where
shown

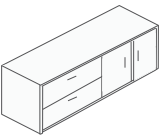
Credenza Lateral/Storage								
	CLS	A	20x72	2,144	2,228	135	306	28
	CLS	B	24x72	2,251	2,462	135	326	30

Credenza Personal Lateral/Storage								
	CPL	A	20x72	2,418	2,607	135	316	28
	CPL	B	24x72	2,524	2,736	135	336	30

TABLE OF CONTENTS

Configuration	Quick Model	Quick Size	Size	Flow	Echo	Carton	B-Weight	Cube
Buffet Credenza Full Hinged Doors								
	HDHD	A	20x72x36	2,324	2,517	182	230	30
	HDHD	B	24x72x36	2,432	2,623	182	250	36
	HDHD	C	20x78x36	2,521	2,714	218	270	33
	HDHD	D	24x78x36	2,612	2,804	218	290	39

ECHO
Edges also included in pricing:
Beveled, Square,
Matrix

Buffet Credenza Hinged Doors & Drawers								
	BBHD	A	20x72x36	2,971	3,173	182	310	30
	BBHD	B	24x72x36	3,080	3,261	182	330	36
	BBHD	C	20x78x36	3,173	3,356	218	350	33
	BBHD	D	24x78x36	3,261	3,445	218	370	39

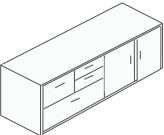
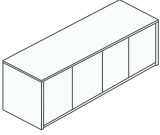
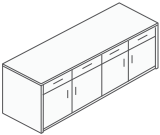
NOTE
Black pulls are standard where
shown

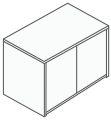
Credenza Hinged Door Storage								
	HD	A	20x36	1,008	1,154	101	180	13
	HD	B	24x36	1,071	1,217	101	190	15
	HD	C	20x36x36	1,186	1,333	126	201	15
	HD	D	24x36x36	1,249	1,396	126	211	18







Buffet Credenza Hinged Door Storage w/Drawers								
	BHD	A	20x36x36	1,323	1,474	112	220	15
	BHD	B	24x36x36	1,394	1,536	112	230	18

TABLE OF CONTENTS

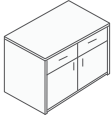
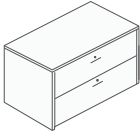
Configuration	Quick Model	Quick Size	Size	Flow	Echo	Carton	B-Weight	Cube
Lateral File 2 Drawer								
	LF	A	20x36	1,116	1,201	87	178	15
	LF	B	24x36	1,201	1,287	87	192	17
Lateral File 3 Drawer								
	LF3	A	20x36x42	1,840	1,981	140	240	17
	LF3	B	24x36x42	1,981	2,122	140	260	20
Lateral File 4 Drawer								
	LF4	A	20x36x54	2,453	2,642	186	300	22
	LF4	B	24x36x54	2,642	2,828	186	320	26
Personal Lateral File								
	PLF	A	20x36	1,394	1,478	87	188	15
	PLF	B	24x36	1,478	1,563	87	202	17
Vertical File 2 Drawer								
	VF	A	24x18	911	996	87	140	8
	VF	B	24x21	1,018	1,107	87	150	9
Vertical File 3 Drawer								
	VF3	A	24x18x42	1,452	1,644	140	200	11
	VF3	B	24x21x42	1,681	1,824	140	220	13
Vertical File 4 Drawer								
	VF4	A	24x18x54	2,003	2,194	186	260	15
	VF4	B	24x21x54	2,240	2,433	186	280	17

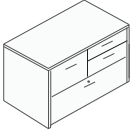
ECHO

Edges also included in pricing:
Beveled, Square,
Matrix

NOTE

High profile furniture should be anchored to the wall by licensed installers using own fasteners

One face lock for each drawer included on file drawers

OPTIONAL GANGLOCK

For 2 Drawer: Add \$109 list

For 3 Drawer: Add \$194 list

For 4 Drawer: Add \$279 list

VERTICAL FILE



A = Letter Size

B = Legal Size

PULLS

Black pulls are standard on lateral and vertical files

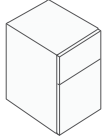
TABLE OF CONTENTS

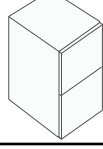
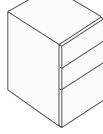
Configuration	Quick Model	Quick Size	Size	Price	Carton	B-Weight	Cube
Free-stand Pedestal Box/File							
	2D	PD	23X16X19.5	590	84	84	6
	2D	PCR	19X16X19.5	590	84	84	6
Free-stand Pedestal Box/Box/Box							
	3D	PD	23X16X19.5	695	97	90	6
	3D	PCR	19X16X19.5	695	97	90	6
Free-stand Pedestal Four Box Drawer							
	4D	PD	23X16X25.5	857	97	109	8
	4D	PCR	19X16X25.5	857	97	109	8
Free-stand Pedestal File/File							
	2H	PD	23X16X25.5	749	97	99	8
	2H	PCR	19X16X25.5	749	97	99	8
Free-stand Pedestal Box/Box/File							
	3H	PD	23X16X25.5	803	97	99	8
	3H	PCR	19X16X25.5	803	97	99	8

NOTE

Finished peds come with 3/4" top and square edges

All drawers come with ball-bearing suspensions



CASTERS or KICK BASE
Add \$61 list for casters or kick base

Pedestal becomes 2" higher

GANGLOCK or PED-LOCK

Add \$109 list

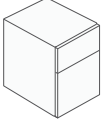
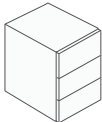
TABLE OF CONTENTS

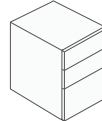
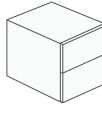
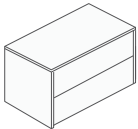
Configuration	Quick Model	Quick Size	Size	Price	Carton	B-Weight	Cube
Hanging Pedestal Box/File							
	2D		23x16x18	322	84	75	4
Hanging Pedestal Box/Box/Box							
	3D		23x16x18	377	84	75	4
Hanging Pedestal Four Box Drawer							
	4D		23x16x24	645	97	100	6
Hanging Pedestal File/File							
	2H		23x16x24	537	97	90	6
Hanging Pedestal Box/Box/File							
	3H		23x16x24	537	97	90	6
Hanging Pedestal – Legal Size File/File							
	2LS		23x20x24	707	97	100	6
Hanging Pedestal Lateral File							
	LF		23x36x24	848	87	120	10

NOTE

Hanging pedestals are designed to customize your desk shell, desk, credenza, etc.

All peds are one side finished, unfinished top and back, and field installable

TABLE OF CONTENTS

WARDROBE

Configuration is applicable for 20x36x72 or higher

Use pricing from Full Hinged (BCW-F-3) and up

Smaller size DON'T have Bottom Shelf

For 24" Depth Laminate, add \$166 list
For 24" Veneer, add \$331 list

For Double Face Lock "Installed on top doors", add \$66 list

For Lock Mechanism "Centered Installed", add \$281 list

Black pulls standard where shown

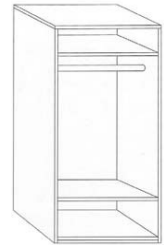

Centered (WD)
Add \$83 list

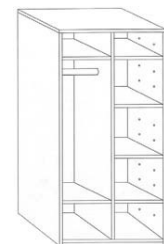

Left (WDL)
Add \$166 list

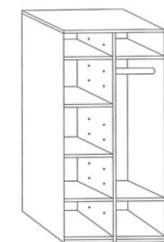

Right (WDR)
Add \$166 list

Configuration	Quick Model	Quick Size	Adj. Selves	Size	Flow	Echo	Carton	B-Weight	Cube
Bookcase									
	BC	A	1	12x36x29	413	451	98	72	11
	BC	B	1	12x36x36	461	502	98	90	14
	BC	C	2	12x36x42	510	549	98	100	16
	BC	D	2	12x36x48	561	599	98	110	18
	BC	E	3	12x36x60	610	647	98	140	22
	BC	F	3	12x36x66	662	698	98	150	24
	BC	G	4	12x36x72	710	747	98	170	26
	BC	H	4	12x36x78	760	797	98	182	28
	BC	I	5	12x36x84	807	845	98	200	30

Bookcase Hinged Doors									
	BCH	A	1	14x36x60	1,141	1,205	186	140	22
	BCH	B	1	14x36x66	1,216	1,254	186	155	24
	BCH	C	2	14x36x72	1,263	1,305	186	170	28
	BCH	D	2	14x36x78	1,314	1,353	186	185	30
	BCH	E	3	14x36x84	1,365	1,403	186	200	32
	BCH	F	1	20x36x60	1,464	1,526	186	177	25
	BCH	G	1	20x36x66	1,562	1,601	186	188	28
	BCH	H	2	20x36x72	1,638	1,674	186	203	30
	BCH	I	2	20x36x78	1,710	1,749	186	218	33
	BCH	J	3	20x36x84	1,785	1,821	186	233	35

Bookcase Full Hinged									
	BCW	A	3	14x36x60	1,697	1,760	186	185	22
	BCW	B	3	14x36x66	1,770	1,808	186	195	24
	BCW	C	4	14x36x72	1,819	1,858	186	220	26
	BCW	D	4	14x36x78	1,869	1,907	186	235	28
	BCW	E	5	14x36x84	1,918	1,957	186	255	30
	BCW	F	3	20x36x60	2,042	2,153	186	218	25
	BCW	G	3	20x36x66	2,117	2,187	186	228	28
	BCW	H	4	20x36x72	2,187	2,229	186	253	30
	BCW	I	4	20x36x78	2,268	2,303	186	268	33
	BCW	J	5	20x36x84	2,340	2,375	186	288	35

Bookcase Lateral File									
	BCL	A	1	20x36x60	2,118	2,174	218	275	28
	BCL	B	1	20x36x66	2,191	2,227	218	300	30
	BCL	C	2	20x36x72	2,239	2,278	218	330	32
	BCL	D	2	20x36x78	2,289	2,326	218	350	34
	BCL	E	3	20x36x84	2,337	2,376	218	370	38

Bookcase Hinged Doors/Lateral File									
	BC5	A	1	20x36x60	2,670	2,730	218	275	28
	BC5	B	1	20x36x66	2,742	2,777	218	300	30
	BC5	C	2	20x36x72	2,793	2,829	218	330	32
	BC5	D	2	20x36x78	2,841	2,878	218	350	34
	BC5	E	3	20x36x84	2,893	2,929	218	370	38

TABLE OF CONTENTS

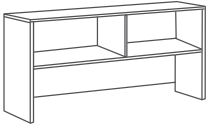
Configuration	Quick Model	Quick Size	Size	Flow	Echo	Carton	B-Weight	Cube
Hutch Open								
	H0	A	14x33x37	747	874	67	110	15
	H0	B	14x45x37	800	928	75	120	18
	H0	C	14x57x37	906	1,033	87	130	22
	H0	D	14x63x37	958	1,088	97	135	25
	H0	E	14x69x37	1,013	1,138	105	145	28
	H0	F	14x75x37	1,117	1,245	116	160	31

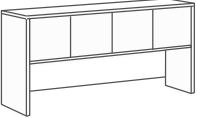
Hutch Hinged Doors								
	H1	A	14x33x37	906	1,033	67	120	15
	H1	B	14x45x37	1,013	1,151	75	130	18
	H1	C	14x57x37	1,117	1,245	87	140	22
	H1	D	14x63x37	1,171	1,295	97	145	25
	H1	E	14x69x37	1,223	1,347	105	155	28
	H1	F	14x75x37	1,329	1,452	116	170	31

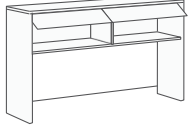
Hutch Garage Doors								
	H2	A	15x33x37	999	1,128	67	120	15
	H2	B	15x45x37	1,192	1,317	75	130	18
	H2	C	15x57x37	1,295	1,422	87	140	22
	H2	D	15x63x37	1,347	1,475	97	145	25
	H2	E	15x69x37	1,402	1,527	105	155	28
	H2	F	15x75x37	1,506	1,634	116	170	31

Hutch Open w/Adjustable Shelves								
	H3	A	14x33x42	849	977	67	115	16
	H3	B	14x45x42	902	1,029	75	125	19
	H3	C	14x57x42	1,008	1,136	87	135	23
	H3	D	14x63x42	1,060	1,185	97	150	27
	H3	E	14x69x42	1,114	1,238	105	165	31
	H3	F	14x75x42	1,219	1,337	116	140	34

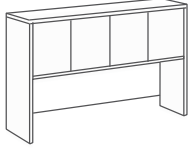
Hutch Hinged Doors w/Adjustable Shelves								
	H4	A	14x33x42	1,176	1,305	67	125	16
	H4	B	14x45x42	1,231	1,358	75	135	19
	H4	C	14x57x42	1,336	1,464	87	145	23
	H4	D	14x63x42	1,390	1,507	97	150	27
	H4	E	14x69x42	1,380	1,569	105	160	31
	H4	F	14x75x42	1,549	1,677	116	175	34

ECHO

Edges also included in pricing:
Beveled, Square,
Matrix

NOTE

High profile furniture should be anchored to the credenza or desk top with provided dowels or metal brackets

Hutches have 20" clearance from the fixed shelf to the work surface, and a 2" gap for wire management

TASK LIGHTS

23" Silver Metal: \$255 list

GLASS DOORS

Frosted Glass Doors (set of 2):
\$331 list

Not available for H2 and H5 hutches

MAIL SORTER

Add \$182 list for mail sorter
Will reduce clearance from work surface by 5"

HINGED DOOR

H1A, H1B, H4A, and H4B come with 2 hinged doors; all others come with 4 hinged doors

GARAGE DOOR

H2A, H2B, H5A, and H5B come with 1 garage door; all others come with 2 garage doors

TACKBOARDS

See page #26 for tackboards

TABLE OF CONTENTS

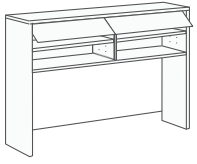
Configuration	Quick Model	Quick Size	Size	Flow	Echo	Carton	B-Weight	Cube
Hutch Garage Doors w/Adjustable Shelves								
	H5	A	15x33x42	1,345	1,470	67	125	16
	H5	B	15x45x42	1,408	1,525	75	135	19
	H5	C	15x57x42	1,504	1,628	87	145	23
	H5	D	15x63x42	1,553	1,682	97	150	27
	H5	E	15x69x42	1,609	1,733	105	160	31
	H5	F	15x75x42	1,712	1,840	116	175	34

Hutch Open w/Adjustable Shelves								
	H6	A	14x33x49	950	1,079	67	120	18
	H6	B	14x45x49	1,028	1,155	75	130	21
	H6	C	14x57x49	1,176	1,306	87	140	24
	H6	D	14x63x49	1,261	1,381	97	145	28
	H6	E	14x69x49	1,329	1,455	105	155	32
	H6	F	14x75x49	1,433	1,562	116	170	36

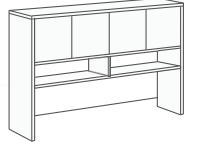
Hutch Hinged Doors w/Fixed Shelf								
	H7	A	14x33x49	1,272	1,401	67	130	18
	H7	B	14x45x49	1,347	1,413	75	140	21
	H7	C	14x57x49	1,498	1,625	87	150	24
	H7	D	14x63x49	1,574	1,681	97	155	28
	H7	E	14x69x49	1,647	1,777	105	165	32
	H7	F	14x75x49	1,756	1,884	116	180	36

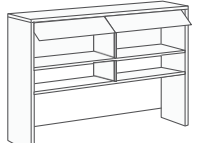
Hutch Garage Doors w/Fixed Shelf								
	H8	A	15x33x49	1,455	1,583	67	130	18
	H8	B	15x45x49	1,540	1,659	75	140	21
	H8	C	15x57x49	1,681	1,808	87	150	24
	H8	D	15x63x49	1,756	1,884	97	155	28
	H8	E	15x69x49	1,832	1,959	105	165	32
	H8	F	15x75x49	1,939	2,066	116	180	36

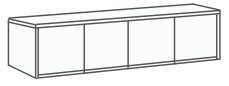
Wall-Mount Overhead								
	H9	A	15x36x15	1,053	1,148	75	62	5
	H9	B	15x48x15	1,246	1,338	87	84	7
	H9	C	15x60x15	1,530	1,626	97	106	8
	H9	D	15x66x15	1,626	1,722	105	117	9
	H9	E	15x72x15	1,722	1,819	116	128	10
	H9	F	15x78x15	2,009	2,105	123	140	11

ECHO

Edges also included in pricing:
Beveled, Square,
Matrix

NOTE

High profile furniture should be anchored to the credenza or desk top with provided dowels or metal brackets

Hutches have 20" clearance from the fixed shelf to the work surface, and a 2" gap for wire management

TASK LIGHTS

23" Silver Metal: \$255 list

GLASS DOORS

Frosted Glass Doors (set of 2):
\$331 list

Not available for H2 and H5 hutches

MAIL SORTER

Add \$182 list for mail sorter
Will reduce clearance from work surface by 5"

HINGED DOOR

H7A, H7B, H9A, and H9B come with 2 hinged doors; all others come with 4 hinged doors

GARAGE DOOR

H8A, H8B, H8A, and H8B come with 1 garage door; all others come with 2 garage doors

WALL-MOUNT OVERHEAD

Licensed installers are recommended to install wall-mounted furniture. Installers must provide fasteners.

WALL-MOUNT OVERHEAD

Add \$339 list for garage doors

TACKBOARDS

See page #26 for tackboards

TABLE OF CONTENTS

LAMINATE W/WOOD EDGE

FLUTED-L & CONCORD-L

TABLE OF CONTENTS

Click text to jump page





<i>pg. 188</i>	<u>DESKS</u>	
<i>pg. 192</i>	<u>DESK UNITS</u>	
<i>pg. 198</i>	<u>BRIDGES/RETURNS</u>	
<i>pg. 200</i>	<u>CREDENZAS</u>	
<i>pg. 204</i>	<u>FILES/STORAGE</u>	
<i>pg. 207</i>	<u>BOOKCASES</u>	
<i>pg. 208</i>	<u>HUTCHES</u>	

TABLE OF CONTENTS

Configuration	Quick Model	Quick Size	Size	Fluted-L	Concord-L	Carton	B-Weight	Cube
Desk Shell No Ped ¾ Modesty – add \$79 for Full (FM)								
	S	A	24x48	1,201	1,317	101	102	24
	S	B	24x60	1,268	1,388	135	120	30
	S	C	24x66	1,394	1,527	135	125	32
	S	D	24x72	1,394	1,527	135	135	35
	S	E	30x48	1,268	1,388	135	120	28
	S	F	30x60	1,268	1,388	135	140	36
	S	G	30x66	1,330	1,458	135	148	35
	S	H	30x72	1,394	1,527	135	154	42
	S	I	36x72	1,478	1,623	135	180	50
	S	J	36x78	1,610	1,764	179	190	54

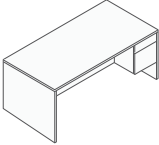
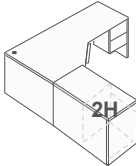
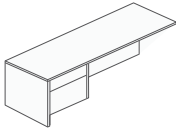
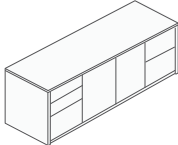
FLUTED-L
Edge also included in pricing:
Saga-L

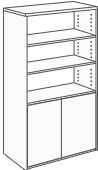
CONCORD-L
Edge also included in pricing:
Victory-L

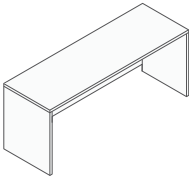
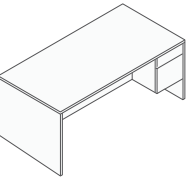
Desk Single ¾ Ped ¾ Modesty – add \$79 for Full (FM)								
	S3	A	24x48	1,456	1,599	101	150	24
	S3	B	30x48	1,523	1,671	101	170	24
	S3	C	30x60	1,523	1,671	135	185	28
	S3	D	30x66	1,586	1,739	179	195	30
	S3	E	30x72	1,652	1,813	101	205	24
	S3	F	36x72	1,739	1,905	135	230	30
	S3	G	36x78	1,865	2,047	179	240	32

FAN TOP

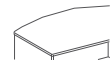

Add \$485 list 6" fan top (FT)

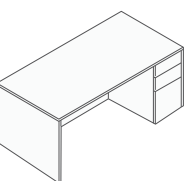
Desk Single Full Ped Full Modesty								
	FP	A	24x48	1,633	1,790	135	160	28
	FP	B	30x48	1,696	1,860	135	170	32
	FP	C	30x60	1,696	1,860	135	190	40
	FP	D	30x66	1,758	1,929	135	210	44
	FP	E	30x72	1,824	1,998	135	230	48
	FP	F	36x72	1,911	2,095	179	250	54
	FP	G	36x78	2,037	2,236	179	280	58

RIGHT OR LEFT
Specify (RP) for Right Pedestal or
(LP) for Left Pedestal

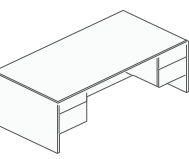
Desk Double ¾ Ped ¾ Modesty – add \$79 for Full (FM)								
	D3	A	30x60	1,781	1,953	135	232	36
	D3	B	30x66	1,843	2,025	135	242	40
	D3	C	30x72	1,911	2,095	135	250	44
	D3	D	36x72	1,996	2,186	135	270	50
	D3	E	36x78	2,122	2,327	179	285	54

Desk Double Full Ped Full Modesty								
	DF	A	30x60	2,122	2,327	135	290	36
	DF	B	30x66	2,187	2,399	135	300	40
	DF	C	30x72	2,251	2,469	135	310	42
	DF	D	36x72	2,338	2,563	135	330	50
	DF	E	36x78	2,465	2,705	179	340	54

TABLE OF CONTENTS

Configuration	Quick Model	Quick Size	Size	Fluted-L	Concord-L	Carton	B-Weight	Cube
Computer Desk Corner Table								
	CCT	A	20-30x30	1,054	1,157	135	80	20
	CCT	B	20-36x36	1,164	1,274	135	100	25
	CCT	C	20-42x42	1,270	1,392	135	124	35
	CCT	D	20-48x48	1,375	1,510	135	150	45
	CCT	E	24-36x36	1,420	1,559	135	110	30
	CCT	F	24-42x42	1,529	1,675	135	120	35
	CCT	G	24-48x48	1,635	1,794	135	155	42

FLUTED-L
Edge also included in pricing:
Saga-L

CONCORD-L
Edge also included in pricing:
Victory-L

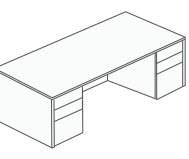
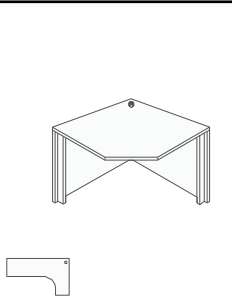
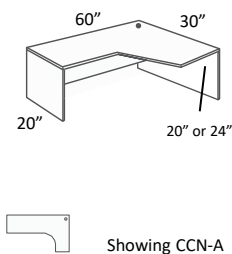
Computer Desk No Ped ¾ Modesty – add \$79 for Full (FM)								
	CCN	A	20-60x30	1,394	1,527	135	184	36
	CCN	B	20-66x30	1,438	1,575	135	192	40
	CCN	C	20-72x30	1,478	1,623	135	210	44
	CCN	D	20-78x30	1,523	1,671	179	230	60
	CCN	E	24-66x36	1,563	1,715	135	200	46
	CCN	F	24-72x36	1,611	1,765	135	210	50
	CCN	G	24-78x36	1,653	1,813	179	230	60
	CCN	H	30-66x42	1,781	1,953	135	250	54
	CCN	I	30-72x42	1,844	2,025	135	260	60
	CCN	J	30-78x42	1,912	2,095	179	272	64
	CCN	K	36-72x48	2,082	2,282	135	285	68
	CCN	L	36-78x48	2,166	2,376	179	300	70

FAN TOP

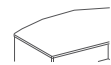

Add \$485 list 6" fan top (FT)

RADIAL CORNER

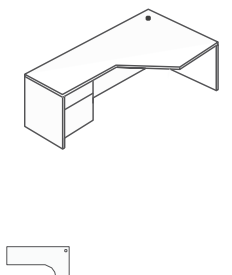

Add \$206 list for radial corner (RC)

Computer Desk ¾ Ped ¾ Modesty – add \$79 for Full (FM)								
	CCS	A	20-60x30	1,653	1,813	135	220	36
	CCS	B	20-66x30	1,696	1,862	135	230	40
	CCS	C	20-72x30	1,739	1,906	135	242	42
	CCS	D	20-78x30	1,781	1,953	179	260	46
	CCS	E	24-66x36	1,824	1,998	135	230	46
	CCS	F	24-72x36	1,912	2,095	135	250	52
	CCS	G	24-78x36	1,954	2,139	179	260	56
	CCS	H	30-66x42	2,082	2,514	135	250	52
	CCS	I	30-72x42	2,144	2,352	135	260	56
	CCS	J	30-78x42	2,208	2,422	179	275	60
	CCS	K	36-72x48	2,381	2,611	135	275	60
	CCS	L	36-78x48	2,466	2,706	179	285	64

RIGHT OR LEFT

Specify (RP) for Right Pedestal or (LP) for Left Pedestal

NOTE

Black grommet standard

TABLE OF CONTENTS

Configuration	Quick Model	Quick Size	Size	Fluted-L	Concord-L	Carton	B-Weight	Cube
Computer Desk Full Ped Full Modesty								
	CDF	A	20-60x30	1,824	1,998	135	190	36
	CDF	B	20-66x30	1,865	1,840	135	200	40
	CDF	C	20-72x30	1,912	2,095	135	225	50
	CDF	D	20-78x30	1,954	2,139	179	235	54
	CDF	E	24-66x36	1,996	2,186	135	245	46
	CDF	F	24-72x36	2,082	2,282	135	255	50
	CDF	G	24-78x36	2,123	2,328	179	265	54
	CDF	H	30-66x42	2,250	2,472	135	265	54
	CDF	I	30-72x42	2,316	2,540	135	275	60
	CDF	J	30-78x42	2,381	2,611	179	285	64
	CDF	K	36-72x48	2,574	2,822	135	300	68
	CDF	L	36-78x48	2,639	2,893	179	320	72

FLUTED-L
Edge also included in pricing:
Saga-L

CONCORD-L
Edge also included in pricing:
Victory-L

FAN TOP

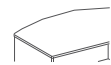

Add \$485 list 6" fan top (FT)

RADIAL CORNER



Add \$206 list for radial corner (RC)

Computer Desk Lateral File w/Black Pulls Full Modesty								
	DL	A	20-72x30	2,400	2,632	135	230	44
	DL	B	20-78x30	2,445	2,682	179	240	48
	DL	C	24-72x36	2,530	2,774	135	255	50
	DL	D	24-78x36	2,574	2,822	179	265	54
	DL	E	30-72x42	2,768	3,035	135	265	60
	DL	F	30-78x42	2,832	3,107	179	305	64
	DL	G	36-72x48	3,005	3,293	135	320	68
	DL	H	36-78x48	3,090	3,388	179	340	72

Computer Desk Personal Lateral File w/Black Pulls Full Modesty								
	CP	A	20-72x30	2,554	2,674	128	238	44
	CP	B	20-78x30	2,597	2,716	170	248	48
	CP	C	24-72x36	2,678	2,802	128	273	50
	CP	D	24-78x36	2,718	2,846	170	263	54
	CP	E	30-72x42	2,902	3,038	128	293	60
	CP	F	30-78x42	2,964	3,102	170	313	64
	CP	G	36-72x48	3,126	3,271	128	328	68
	CP	H	36-78x48	3,208	3,357	170	348	72

RIGHT OR LEFT
Specify (RP) for Right Pedestal or
(LP) for Left Pedestal

NOTE
Black grommet standard

TABLE OF CONTENTS

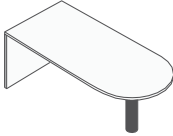
Configuration	Quick Model	Quick Size	Size	Fluted-L	Concord-L	Carton	B-Weight	Cube
Bullet Desk No Ped ¾ Modesty – add \$79 for Full (FM)								
	BN	A	30x60	1,674	1,836	135	130	36
	BN	B	30x66	1,804	1,977	135	154	42
	BN	C	30x72	1,804	1,977	135	145	43
	BN	D	36x72	1,912	2,095	135	165	50
	BN	E	36x78	2,123	2,328	179	200	64
	BN	F	42x84	2,340	2,563	179	220	68

FLUTED-L

Edge also included in pricing:
Saga-L

CONCORD-L

Edge also included in pricing:
Victory-L

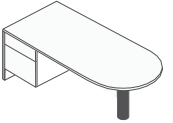
Bullet Desk ¾ Ped ¾ Modesty – add \$79 for Full (FM)								
	BS	A	30x60	1,929	2,118	135	235	42
	BS	B	30x66	2,059	2,259	135	235	42
	BS	C	30x72	2,059	2,259	135	245	50
	BS	D	36x72	2,166	2,376	179	265	54
	BS	E	36x78	2,381	2,611	179	275	64
	BS	F	42x84	2,594	2,845	179	285	68

NOTE

BN model not intended for sale as freestanding desk. See bridges and returns.

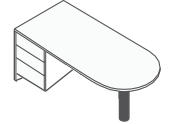
Bullet Desk Full Ped Full Modesty								
	BF	A	30x60	2,058	2,258	133	230	38
	BF	B	30x66	2,187	2,399	133	240	40
	BF	C	30x72	2,187	2,399	133	250	40
	BF	D	36x72	2,294	2,514	133	265	42
	BF	E	36x78	2,508	2,751	178	275	46
	BF	F	42x84	2,726	2,988	179	310	50

POST

Standard in black

Available in silver, add \$32 list

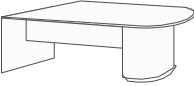
Bullet Desk ½ Cylinder Desk No Ped add \$79 for Full Modesty (FM)								
	BCN	A	30x60	2,208	2,422	135	255	42
	BCN	B	30x66	2,340	2,563	135	270	44
	BCN	C	30x72	2,340	2,563	135	270	44
	BCN	D	36x72	2,445	2,682	135	285	48
	BCN	E	36x78	2,660	2,918	179	310	60
	BCN	F	42x84	2,874	3,152	179	330	64

RIGHT OR LEFT

Specify (RP) for Right Pedestal or (LP) for Left Pedestal

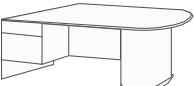
Bullet Desk ¾ Ped ¾ Modesty – add \$79 for Full (FM)								
	BCS	A	30x60	2,466	2,706	135	260	40
	BCS	B	30x66	2,594	2,845	135	280	42
	BCS	C	30x72	2,594	2,845	135	300	44
	BCS	D	36x72	2,704	2,965	135	320	44
	BCS	E	36x78	2,917	3,201	179	340	52
	BCS	F	42x84	3,132	3,434	179	350	64





Bullet Desk Full Ped Full Modesty								
	BCF	A	30x60	2,594	2,845	135	270	42
	BCF	B	30x66	2,726	2,988	135	270	44
	BCF	C	30x72	2,726	2,988	135	310	46
	BCF	D	36x72	2,832	3,107	135	320	48
	BCF	E	36x78	3,047	3,341	179	340	54
	BCF	F	42x84	3,260	3,575	179	360	64

TABLE OF CONTENTS

Configuration	Quick Model	Quick Size	Size	Fluted-L	Concord-L	Carton	B-Weight	Cube
L-Shaped Desk ¾ Ped ¾ Modesty – add \$158 for Full (FM)								
	D	1	30x66 Desk 24x42 Return	2,907	3,184	252	300	64
	D	2	36x72 Desk 24x48 Return	3,096	3,397	252	355	75
L-Shaped Desk Full Ped Full Modesty								
	D	3	36x72 Desk 24x48 Return	3,507	3,847	252	410	75
L-Shaped Computer Desk ¾ Ped ¾ Modesty – add \$158 for Full (FM)								
 	D	4	36-72x48 Desk 24x48 Return	3,700	4,058	305	340	75
L-Shaped Computer Desk Full Ped Full Modesty								
 	D	5	36-72x48 Desk 24x48 Return	4,107	4,502	305	367	75

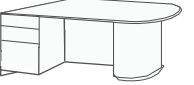
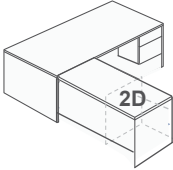
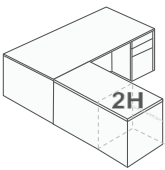
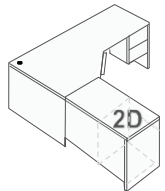
FLUTED-L

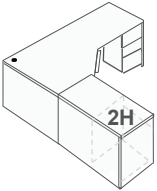
Edge also included in pricing:
Saga-L

CONCORD-L

Edge also included in pricing:
Victory-L

FAN TOP



Add \$485 list for 6" fan top (FT)

RADIAL CORNER



Add \$206 list for radial corner (RC)





RIGHT OR LEFT

Specify (R) for Right Return or (L)
for Left Return

NOTE

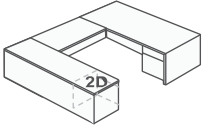
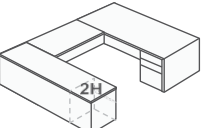
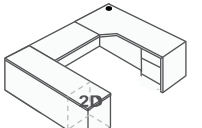
Black grommet are standard on
Computer Desk

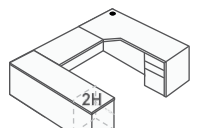
TABLE OF CONTENTS

Configuration	Quick Model	Quick Size	Size	Fluted-L	Concord-L	Carton	B-Weight	Cube
U-Shaped Desk ¾ Ped ¾ Modesty – add \$158 for Full (FM)								
	D	6	36X72 Desk 24x48 Bridge 24x72 Credenza	4,418	4,844	346	455	98
U-Shaped Desk Full Ped Full Modesty								
	D	7	36X72 Desk 24x48 Bridge 24x72 Credenza	4,761	5,222	346	580	115
U-Shaped Computer Desk ¾ Ped ¾ Modesty – add \$158 for Full (FM)								
 	D	8	30-72x42 Desk 24x48 Bridge 24x72 Credenza	4,739	5,196	346	455	98
U-Shaped Computer Desk Full Ped Full Modesty								
 	D	9	30-72x42 Desk 24x48 Bridge 24x72 Credenza	5,085	5,574	346	580	115

FLUTED-L

Edge also included in pricing:
Saga-L

CONCORD-L

Edge also included in pricing:
Victory-L

FAN TOP



Add \$485 list for 6" fan top (FT)

RADIAL CORNER



Add \$206 list for radial corner (RC)

RIGHT OR LEFT

Specify (R) for Right Bridge or (L)
for Left Bridge

NOTE

Black grommet are standard on
Computer Desk

TABLE OF CONTENTS

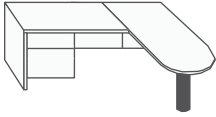
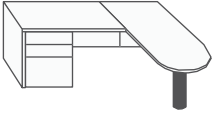
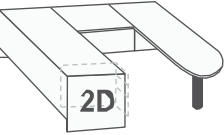
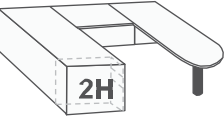
Configuration	Quick Model	Quick Size	Size	Fluted-L	Concord-L	Carton	B-Weight	Cube
L-Shaped Bullet Desk ¾ Ped ¾ Modesty – add \$158 for Full (FM)								
	D	10	36X72 Desk 24x48 Return	3,273	3,590	225	290	68
L-Shaped Bullet Desk Full Ped Full Modesty								
	D	11	36X72 Desk 24x48 Return	3,508	3,847	225	315	72
U-Shaped Bullet Desk ¾ Ped ¾ Modesty – add \$158 for Full (FM)								
	D	12	36x72 Desk 24x48 Bridge 24x72 Credenza	4,589	5,033	330	555	96
U-Shaped Bullet Desk Full Ped Full Modesty								
	D	13	36x72 Desk 24x48 Bridge 24x72 Credenza	5,192	5,692	330	583	96

FLUTED-L

Edge also included in pricing:
Saga-L

CONCORD-L

Edge also included in pricing:
Victory-L

POST

Standard in black

Available in silver, add \$32 list

RIGHT OR LEFT

Specify (R) for Right Bridge or (L)
for Left Bridge

TABLE OF CONTENTS

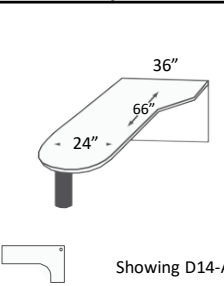
Configuration	Quick Model	Quick Size	Size	Fluted-L	Concord-L	Carton	B-Weight	Cube
Bullet Computer Desk Shell ¾ Modesty – add \$79 for Full (FM)								
 <p>Showing D14-A</p>	D14	A	24-66X36	2,003	2,199	135	125	42
	D14	B	24-72X36	2,111	2,315	135	135	45
	D14	C	24-78X36	2,220	2,435	179	145	48
	D14	D	30-66X42	2,328	2,554	135	145	51
	D14	E	30-72X42	2,437	2,669	135	155	54
	D14	F	30-78X42	2,541	2,787	179	165	57
	D14	G	36-66X48	2,648	2,905	135	165	60
	D14	H	36-72X48	2,755	3,023	135	175	63
	D14	I	36-78X48	2,864	3,139	179	185	66

FLUTED-L

Edge also included in pricing:
Saga-L

CONCORD-L

Edge also included in pricing:
Victory-L

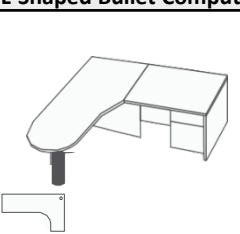
L-Shaped Bullet Computer Desk ¾ Ped ¾ Modesty – add \$158 for Full (FM)								
	D	15	30-72x42 Desk 24x48 Return	3,798	4,165	225	255	78

NOTE

D14 model not intended for sale as freestanding desk. See bridges and returns.

RADIAL CORNER

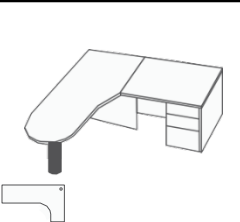

Add \$206 list for radial corner (RC)

L-Shaped Bullet Computer Desk Full Ped Full Modesty								
	D	16	30-72x42 Desk 24x48 Return	4,034	4,422	225	285	78

POST

Standard in black

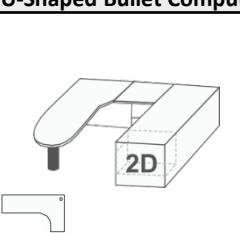
U-Shaped Bullet Computer Desk ¾ Ped ¾ Modesty – add \$158 for Full (FM)								
	D	17	30-72x42 Desk 24x42 Bridge 24x72 Credenza	5,070	5,562	368	465	106

Available in silver, add \$32 list

RIGHT OR LEFT

Specify (R) for Right Bridge or (L) for Left Bridge

U-Shaped Bullet Computer Desk Full Ped Full Modesty								
	D	18	30-72x42 Desk 24x42 Bridge 24x72 Credenza	5,242	5,751	368	495	106

TABLE OF CONTENTS

Configuration	Quick Model	Quick Size	Size	Fluted-L	Concord-L	Carton	B-Weight	Cube
P-Shaped Desk Shell ¾ Modesty – add \$79 for Full (FM)								
 <p>Showing D19-A</p>	D19	A	36-66x24	2,338	2,563	135	105	42
	D19	B	36-72x24	2,465	2,705	144	120	45
	D19	C	36-78x24	2,593	2,845	159	135	49
	D19	D	42-66x30	2,725	2,987	144	150	48
	D19	E	42-72x30	2,747	3,011	159	165	53
	D19	F	42-78x30	2,874	3,152	168	180	57
	D19	G	48-66x36	2,832	3,107	159	195	55
	D19	H	48-72x36	2,959	3,248	168	210	60
	D19	I	48-78x36	3,089	3,386	179	225	66
L-Shaped P-Desk ¾ Ped ¾ Modesty – add \$158 for Full (FM)								
	D	20	48-78x36 Desk 24x48 Return	4,450	4,879	269	285	86
L-Shaped P-Desk Full Ped Full Modesty								
	D	21	48-78x36 Desk 24x48 Return	4,688	5,140	269	298	86
U-Shaped P-Desk ¾ Ped ¾ Modesty – add \$158 for Full (FM)								
	D	22	48-78x36 Desk 24x48 Bridge 24x78 Credenza	5,767	6,326	402	508	119
U-Shaped P-Desk Full Ped Full Modesty								
	D	23	48-78x36 Desk 24x48 Bridge 24x78 Credenza	6,369	6,985	402	538	119

FLUTED-L

Edge also included in pricing:
Saga-L

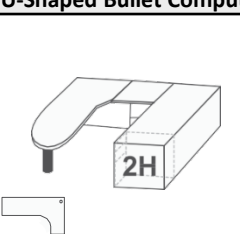
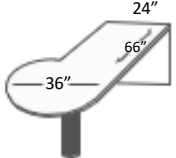
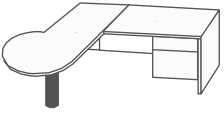
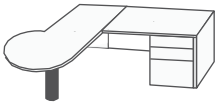
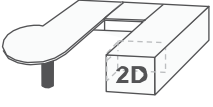
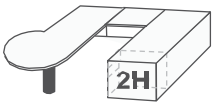
CONCORD-L

Edge also included in pricing:
Victory-L

NOTE

D19 model not intended for sale as freestanding desk. See bridges and returns.

POST

Standard in black

Available in silver, add \$32 list

RIGHT OR LEFT

Specify (R) for Right Bridge or (L) for Left Bridge

TABLE OF CONTENTS

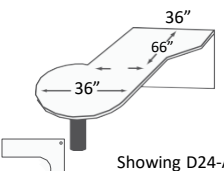
Configuration	Quick Model	Quick Size	Size	Fluted-L	Concord-L	Carton	B-Weight	Cube
P-Shaped Computer Desk Shell ¾ Modesty – add \$79 for Full (FM)								
 <p>Showing D24-A</p>	D24	A	36-66x36	3,046	3,340	135	80	80
	D24	B	36-72x36	3,174	3,480	135	106	106
	D24	C	36-78x36	3,302	3,622	179	106	106
	D24	D	42-66x42	3,205	3,516	179	106	106
	D24	E	42-72x42	3,336	3,659	179	106	106
	D24	F	42-78x42	3,464	3,799	225	106	106

FLUTED-L
Edge also included in pricing:
Saga-L

CONCORD-L
Edge also included in pricing:
Victory-L

NOTE
D24 model not intended for sale as freestanding desk. See bridges and returns.

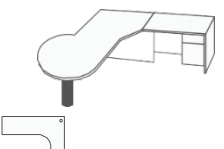
P-Shaped Computer Desk ¾ Ped ¾ Modesty – add \$158 for Full (FM)								
	D	25	36-78x36 Desk 24x48 Return	4,666	5,118	269	285	86

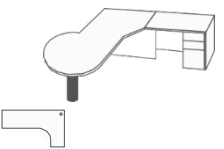
P-Shaped Computer Desk Full Ped Full Modesty								
	D	26	36-78x36 Desk 24x48 Return	4,836	5,301	269	298	86

RADIAL CORNER

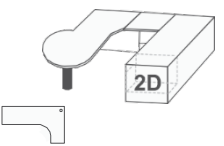

Add \$206 list for radial corner (RC)

U-Shaped P-Desk ¾ Ped ¾ Modesty – add \$158 for Full (FM)								
	D	27	36-78x36 Desk 24x48 Bridge 24x78 Credenza	6,090	6,681	402	508	119

POST
Standard in black
Available in silver, add \$32 list

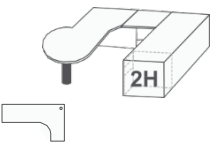
U-Shaped P-Desk Full Ped Full Modesty								
	D	28	36-78x36 Desk 24x48 Bridge 24x78 Credenza	6,262	6,865	402	538	119

RIGHT OR LEFT
Specify (R) for Right Bridge or (L) for Left Bridge

TABLE OF CONTENTS

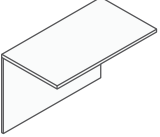
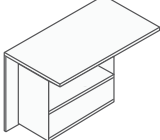
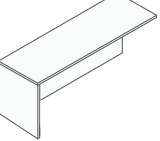
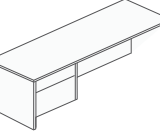
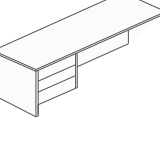
Configuration	Quick Model	Quick Size	Size	Fluted-L	Concord-L	Carton	B-Weight	Cube
Bridge ¾ Mod w/2D Desk or Credenza Full Mod w/3H Desk or Credenza								
	B	A	20x36	850	949	101	55	15
	B	B	20x42	889	993	101	60	17
	B	C	20x48	932	1,042	101	65	19
	B	D	20x54	971	1,087	101	70	21
	B	E	24x36	932	1,042	101	60	18
	B	F	24x42	971	1,087	101	65	21
	B	G	24x48	1,014	1,132	101	70	24
	B	H	24x54	1,054	1,178	101	75	27
Bridge 12" Deep Bookcase								
	1BB	A	20x36	1,261	1,413	101	90	15
	1BB	B	20x42	1,192	1,456	101	95	17
	1BB	C	20x48	1,346	1,503	101	100	19
	1BB	D	20x54	1,387	1,550	101	105	21
	1BB	E	24x36	1,346	1,503	101	100	18
	1BB	F	24x42	1,268	1,548	101	105	21
	1BB	G	24x48	1,428	1,596	101	115	24
	1BB	H	24x54	1,471	1,642	101	125	27
Return Shell ¾ modesty – add \$79 for Full (FM)								
	R	A	20x36	901	1,005	101	55	15
	R	B	20x42	942	1,050	101	60	17
	R	C	20x48	982	1,097	101	65	19
	R	D	20x54	1,025	1,143	101	70	21
	R	E	24x36	982	1,097	101	75	18
	R	F	24x42	1,022	1,142	101	85	21
	R	G	24x48	1,069	1,192	101	60	24
	R	H	24x54	1,108	1,239	101	65	27
Return ¾ Ped (Box/File) ¾ modesty – add \$79 for Full (FM)								
	R2	A	20x36	1,150	1,286	101	75	15
	R2	B	20x42	1,188	1,331	101	80	17
	R2	C	20x48	1,233	1,377	101	85	19
	R2	D	20x54	1,274	1,423	101	90	21
	R2	E	24x36	1,233	1,377	101	80	18
	R2	F	24x42	1,272	1,421	101	85	21
	R2	G	24x48	1,314	1,471	101	100	24
	R2	H	24x54	1,358	1,517	101	115	27
Return ¾ Ped (Box/Box/Box) ¾ modesty – add \$79 for Full (FM)								
	R3	A	20x36	1,237	1,380	101	75	15
	R3	B	20x42	1,277	1,425	101	80	17
	R3	C	20x48	1,320	1,474	101	85	19
	R3	D	20x54	1,360	1,522	101	90	21
	R3	E	24x36	1,320	1,474	101	80	17
	R3	F	24x42	1,360	1,520	101	85	19
	R3	G	24x48	1,403	1,566	101	100	24
	R3	H	24x54	1,443	1,616	101	115	27

FLUTED-L
Edge also included in pricing:
Saga-L

CONCORD-L
Edge also included in pricing:
Victory-L

RIGHT OR LEFT
Specify (R) for Right or (L) for
Left

TABLE OF CONTENTS

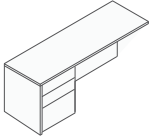
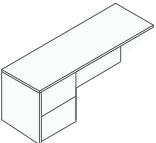
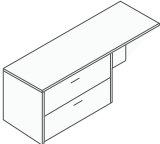
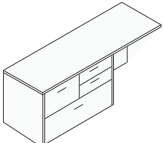
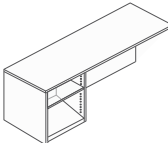
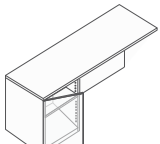
Configuration	Quick Model	Quick Size	Size	Fluted-L	Concord-L	Carton	B-Weight	Cube
Return Full Ped (Box/Box/File) Full Modesty								
	RF	A	20x36	1,415	1,577	101	105	15
	RF	B	20x42	1,456	1,624	101	115	17
	RF	C	20x48	1,496	1,682	101	125	19
	RF	D	20x54	1,550	1,731	101	135	21
	RF	E	24x36	1,496	1,674	101	140	18
	RF	F	24x42	1,538	1,716	101	150	24
	RF	G	24x48	1,583	1,771	101	155	24
	RF	H	24x54	1,621	1,806	101	160	27
Return Full Ped (File/File) Full Modesty								
	RL	A	20x36	1,348	1,508	101	105	15
	RL	B	20x42	1,395	1,555	101	115	17
	RL	C	20x48	1,434	1,601	101	125	19
	RL	D	20x54	1,477	1,649	101	135	21
	RL	E	24x36	1,434	1,601	101	140	18
	RL	F	24x42	1,476	1,647	101	150	21
	RL	G	24x48	1,518	1,698	101	155	24
	RL	H	24x54	1,563	1,738	101	160	27
Return Lateral File w/Standard Black Pulls Full Modesty								
	RLF	A	20x48	1,913	2,136	101	175	19
	RLF	B	20x54	1,953	2,183	101	180	21
	RLF	C	20x60	1,997	2,230	101	185	24
	RLF	D	24x48	1,997	2,230	101	180	24
	RLF	E	24x54	2,037	2,277	101	185	27
	RLF	F	24x60	2,078	2,323	101	190	29
Return Personal Lateral File w/Standard Black Pulls Full Modesty								
	PF	A	20x48	2,161	2,371	101	184	19
	PF	B	20x54	2,205	2,416	101	189	21
	PF	C	20x60	2,245	2,462	101	194	24
	PF	D	24x48	2,245	2,462	101	184	24
	PF	E	24x54	2,289	2,510	101	189	27
	PF	F	24x60	2,328	2,555	101	194	30
Return Personal Printer w/Adjustable Shelf Full Modesty								
	PP	A	20x48	1,423	1,560	101	92	19
	PP	B	20x54	1,466	1,605	101	102	21
	PP	C	20x60	1,507	1,653	101	112	24
	PP	D	24x48	1,507	1,653	101	122	24
	PP	E	24x54	1,550	1,700	101	132	27
	PP	F	24x60	1,591	1,745	101	142	30
Return Personal Printer w/Door Full Modesty								
	PPD	A	20x48	1,621	1,766	101	92	19
	PPD	B	20x54	1,663	1,812	101	102	21
	PPD	C	20x60	1,704	1,858	101	112	24
	PPD	D	24x48	1,704	1,858	101	122	24
	PPD	E	24x54	1,746	1,906	101	132	27
	PPD	F	24x60	1,787	1,953	101	142	30

FLUTED-L

Edge also included in pricing:
Saga-L

CONCORD-L

Edge also included in pricing:
Victory-L

RIGHT OR LEFT

Specify (R) for Right Return or
(L) for Left Return

PULLS

Black pulls are standard on
Lateral Files

TABLE OF CONTENTS

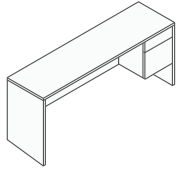
Configuration	Quick Model	Quick Size	Size	Fluted-L	Concord-L	Carton	B-Weight	Cube
Kneespace Credenza ¼ Ped ¾ modesty – add \$79 for Full (FM)								
	C3	A	20x60	1,348	1,481	135	175	22
	C3	B	20x66	1,413	1,549	135	180	26
	C3	C	20x72	1,475	1,618	135	185	28
	C3	D	20x78	1,537	1,686	179	190	30
	C3	E	24x60	1,475	1,618	135	180	26
	C3	F	24x66	1,537	1,686	135	185	28
	C3	G	24x72	1,604	1,760	135	190	30
	C3	H	24x78	1,709	1,872	179	200	32

FLUTED-L

Edge also included in pricing:
Saga-L

CONCORD-L

Edge also included in pricing:
Victory-L

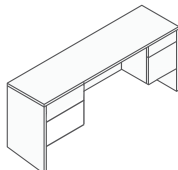
Kneespace Credenza Double ¼ Ped ¾ modesty – add \$79 for Full (FM)								
	CK	A	20x60	1,674	1,836	135	195	24
	CK	B	20x66	1,739	1,906	135	205	26
	CK	C	20x72	1,804	1,977	135	215	28
	CK	D	20x78	1,865	2,048	179	225	30
	CK	E	24x60	1,781	1,953	135	205	26
	CK	F	24x66	1,844	2,025	135	215	28
	CK	G	24x72	1,912	2,095	135	225	30
	CK	H	24x78	1,975	2,164	179	235	32

RIGHT OR LEFT

Specify (R) for Right Ped or Left (L) or Left Ped on credenza w/single ped

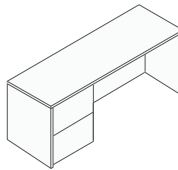
Kneespace Credenza Full Ped (File/File) Full Modesty								
	CSP	A	20x60	1,517	1,663	135	182	22
	CSP	B	20x66	1,583	1,733	135	192	26
	CSP	C	20x72	1,645	1,804	135	202	28
	CSP	D	20x78	1,709	1,872	179	212	30
	CSP	E	24x60	1,645	1,804	135	187	26
	CSP	F	24x66	1,709	1,872	135	192	28
	CSP	G	24x72	1,772	1,943	135	222	30
	CSP	H	24x78	1,878	2,059	179	232	32

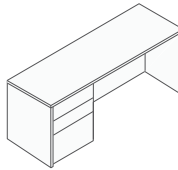
Kneespace Credenza Full Ped (Box/Box/File) Full Modesty								
	CS3	A	20x60	1,517	1,663	135	182	22
	CS3	B	20x66	1,583	1,733	135	192	26
	CS3	C	20x72	1,645	1,804	135	202	28
	CS3	D	20x78	1,709	1,872	179	212	30
	CS3	E	24x60	1,645	1,804	135	187	26
	CS3	F	24x66	1,709	1,872	135	192	28
	CS3	G	24x72	1,772	1,943	135	222	30
	CS3	H	24x78	1,878	2,059	179	232	32

Kneespace Credenza Double Full Ped Full Modesty								
	CN	A	20x60	2,018	2,210	135	185	24
	CN	B	20x66	2,082	2,282	135	190	26
	CN	C	20x72	2,144	2,352	135	198	28
	CN	D	20x78	2,208	2,422	179	210	30
	CN	E	24x60	2,123	2,328	135	190	26
	CN	F	24x66	2,190	2,400	135	198	28
	CN	G	24x72	2,251	2,472	135	210	30
	CN	H	24x78	2,316	2,541	179	220	32

TABLE OF CONTENTS

Configuration	Quick Model	Quick Size	Size	Fluted-L	Concord-L	Carton	B-Weight	Cube
Credenza ¾ Storage w/Hinged Doors ¾ modesty – add \$79 for Full (FM)								
	CS	A	20x60	1,696	1,862	135	175	22
	CS	B	20x66	1,758	1,929	135	180	26
	CS	C	20x72	1,824	1,998	135	185	28
	CS	D	20x78	1,889	2,070	179	190	30
	CS	E	24x60	1,804	1,977	135	180	26?
	CS	F	24x66	2,295	2,516	135	185	28
	CS	G	24x72	1,929	2,118	135	190	30
	CS	H	24x78	1,997	2,188	179	200	32

FLUTED-L
Edge also included in pricing:
Saga-L

CONCORD-L
Edge also included in pricing:
Victory-L

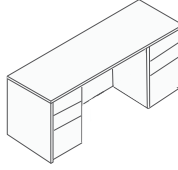
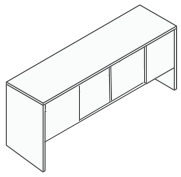
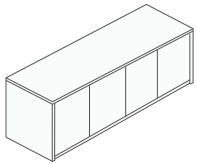
Credenza Full Storage w/Hinged Doors Full Modesty								
	CT	A	20x60	2,227	2,442	135	185	24
	CT	B	20x66	2,291	2,513	135	190	26
	CT	C	20x72	2,357	2,583	135	195	28
	CT	D	20x78	2,420	2,652	179	200	30
	CT	E	24x60	2,333	2,561	135	190	26
	CT	F	24x66	2,399	2,630	135	195	28
	CT	G	24x72	2,463	2,702	135	200	30
	CT	H	24x78	2,527	2,771	179	205	32

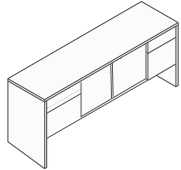
Credenza ¾ Ped w/Hinged Doors ¾ modesty – add \$79 for Full (FM)								
	CA	A	20x60	1,729	1,895	132	220	24
	CA	B	20x66	1,793	1,965	132	225	26
	CA	C	20x72	1,856	2,034	132	230	28
	CA	D	20x78	1,919	2,103	176	240	30
	CA	E	24x60	1,832	2,012	132	225	24
	CA	F	24x66	1,895	2,081	132	230	28
	CA	G	24x72	1,961	2,149	132	235	30
	CA	H	24x78	2,024	2,220	176	245	32

Credenza Full Ped w/Hinged Doors Full Modesty								
	CF	A	20x60	2,340	2,563	135	250	24
	CF	B	20x66	2,401	2,632	135	258	26
	CF	C	20x72	2,466	2,706	135	268	28
	CF	D	20x78	2,530	2,774	179	280	30
	CF	E	24x60	2,445	2,682	135	258	26
	CF	F	24x66	2,509	2,752	135	268	28
	CF	G	24x72	2,574	2,822	135	280	30
	CF	H	24x78	2,704	2,965	179	292	32

TABLE OF CONTENTS

Configuration	Quick Model	Quick Size	Size	Fluted-L	Concord-L	Carton	B-Weight	Cube
Knespace Credenza Personal Lateral								
	CPK	A	20x72	2,376	2,605	135	228	28
	CPK	B	20x78	2,439	2,676	179	238	30
	CPK	C	24x72	2,568	2,815	135	248	30
	CPK	D	24x78	2,633	2,888	179	258	32

FLUTED-L

Edge also included in pricing:
Saga-L

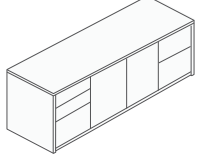
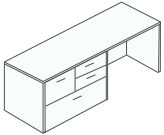
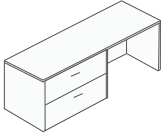
Knespace Credenza Lateral File								
	CL	A	20x72	2,102	2,307	135	220	28
	CL	B	20x78	2,166	2,376	179	230	30
	CL	C	24x72	2,230	2,449	135	240	30
	CL	D	24x78	2,295	2,516	179	250	32

CONCORD-L

Edge also included in pricing:
Victory-L

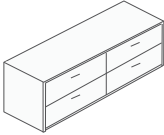
Credenza Double Lateral								
	CDL	A	20x72	2,525	2,916	135	340	28
	CDL	B	24x72	2,696	2,957	135	360	30

RIGHT OR LEFT

Specify (RP) for Right Ped or
(LP) for Left Ped on credenza
w/single ped

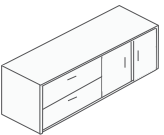
Credenza Lateral/Storage								
	CLS	A	20x72	2,524	2,766	135	306	28
	CLS	B	24x72	2,652	2,906	135	326	30

NOTE

Black pulls are standard where
shown

Credenza Personal Lateral/Storage								
	CPL	A	20x72	2,799	3,075	135	316	28
	CPL	B	24x72	2,925	3,205	135	336	30

TABLE OF CONTENTS

Configuration	Quick Model	Quick Size	Size	Fluted-L	Concord-L	Carton	B-Weight	Cube
Buffet Credenza Full Hinged Doors								
	HDHD	A	20x72x36	2,709	2,951	182	230	30
	HDHD	B	24x72x36	2,816	3,070	182	250	36
	HDHD	C	20x78x36	2,905	3,165	218	270	33
	HDHD	D	24x78x36	2,997	3,259	218	290	39

FLUTED-L

Edge also included in pricing:
Saga-L

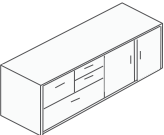
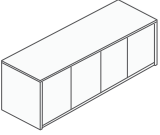
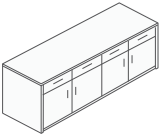
Buffet Credenza Hinged Doors & Drawers								
	BBHD	A	20x72x36	3,354	3,626	182	310	30
	BBHD	B	24x72x36	3,461	3,758	182	330	36
	BBHD	C	20x78x36	3,548	3,818	218	350	33
	BBHD	D	24x78x36	3,642	3,930	218	370	39

CONCORD-L

Edge also included in pricing:
Victory-L

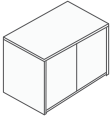
Credenza Hinged Door Storage								
	HD	A	20x36	1,345	1,473	101	180	13
	HD	B	24x36	1,407	1,526	101	190	15
	HD	C	20x36x36	1,524	1,660	126	201	15
	HD	D	24x36x36	1,585	1,729	126	211	18

NOTE

Black pulls are standard where shown







Buffet Credenza Hinged Door Storage w/Drawers								
	BHD	A	20x36x36	1,663	1,806	112	220	15
	BHD	B	24x36x36	1,733	1,881	112	230	18

TABLE OF CONTENTS

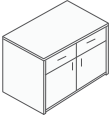
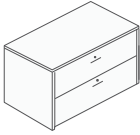
Configuration	Quick Model	Quick Size	Size	Fluted-L	Concord-L	Carton	B-Weight	Cube
Lateral File 2 Drawer								
	LF	A	20x36	1,319	1,446	101	178	15
	LF	B	24x36	1,407	1,542	101	192	17
Lateral File 3 Drawer								
	LF3	A	20x36x42	2,175	2,386	162	240	17
	LF3	B	24x36x42	2,320	2,543	162	260	20
Lateral File 4 Drawer								
	LF4	A	20x36x54	2,902	3,181	218	300	22
	LF4	B	24x36x54	3,094	3,391	218	320	26
Personal Lateral File								
	PLF	A	20x36	1,598	1,753	101	188	15
	PLF	B	24x36	1,684	1,845	101	202	17
Vertical File 2 Drawer								
	VF	A	24x18	1,116	1,223	101	140	8
	VF	B	24x21	1,222	1,339	101	150	9
Vertical File 3 Drawer								
	VF3	A	24x18x42	1,841	2,018	162	200	11
	VF3	B	24x21x42	2,018	2,210	162	220	13
Vertical File 4 Drawer								
	VF4	A	24x18x54	2,453	2,690	218	260	15
	VF4	B	24x21x54	2,689	2,817	218	280	17

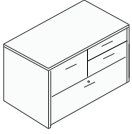
FLUTED-L
Edge also included in pricing:
Saga-L

CONCORD-L
Edge also included in pricing:
Victory-L

NOTE
High profile furniture should be anchored to the wall by licensed installers using own fasteners

One face lock for each drawer included on file drawers

OPTIONAL GANGLOCK

For 2 Drawer: Add \$109 list

For 3 Drawer: Add \$194 list

For 4 Drawer: Add \$279 list

VERTICAL FILE





A = Letter Size

B = Legal Size

PULLS

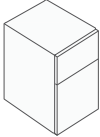
Black pulls are standard on lateral and vertical files

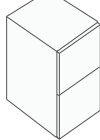
TABLE OF CONTENTS

Configuration	Quick Model	Quick Size	Size	Price	Carton	B-Weight	Cube
Free-stand Pedestal Box/File							
	2D	PD	23X16X19.5	590	84	84	6
	2D	PCR	19X16X19.5	590	84	84	6
Free-stand Pedestal Box/Box/Box							
	3D	PD	23X16X19.5	695	97	90	6
	3D	PCR	19X16X19.5	695	97	90	6
Free-stand Pedestal Four Box Drawer							
	4D	PD	23X16X25.5	857	97	109	8
	4D	PCR	19X16X25.5	857	97	109	8
Free-stand Pedestal File/File							
	2H	PD	23X16X25.5	749	97	99	8
	2H	PCR	19X16X25.5	749	97	99	8
Free-stand Pedestal Box/Box/File							
	3H	PD	23X16X25.5	803	97	99	8
	3H	PCR	19X16X25.5	803	97	99	8

NOTE

Finished peds come with 3/4" top and square edges

All drawers come with ball-bearing suspensions

CASTERS or KICK BASE
Add \$61 list for casters or kick base

Pedestal becomes 2" higher

GANGLOCK or PED-LOCK

Add \$109 list

TABLE OF CONTENTS

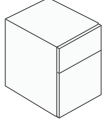
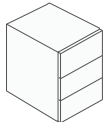
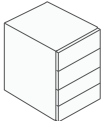
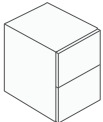
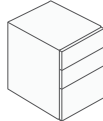
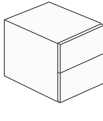
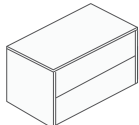
Configuration	Quick Model	Quick Size	Size	Price	Carton	B-Weight	Cube
Hanging Pedestal Box/File							
	2D		23x16x18	322	84	75	4
Hanging Pedestal Box/Box/Box							
	3D		23x16x18	377	84	75	4
Hanging Pedestal Four Box Drawer							
	4D		23x16x24	644	92	100	6
Hanging Pedestal File/File							
	2H		23x16x24	537	97	90	6
Hanging Pedestal Box/Box/File							
	3H		23x16x24	537	97	90	6
Hanging Pedestal – Legal Size File/File							
	2LS		23x20x24	707	97	100	6
Hanging Pedestal Lateral File							
	LF		23x36x24	848	87	120	10

NOTE

Hanging pedestals are designed to customize your desk shell, desk, credenza, etc.

All peds are one side finished, unfinished top and back, and field installable

TABLE OF CONTENTS

WARDROBE

Configuration is applicable for 20x36x72 or higher

Use pricing from Full Hinged (BCW-F-3) and up

Smaller size DON'T have Bottom Shelf

For 24" Depth Laminate, add \$166 list
For 24" Veneer, add \$331 list

For Double Face Lock "Installed on top doors", add \$66 list

For Lock Mechanism "Centered Installed", add \$281 list

Black pulls standard where shown

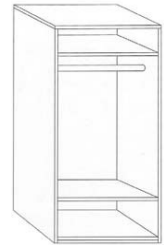

Centered (WD)
Add \$79 list

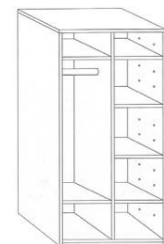

Left (WDL)
Add \$158 list

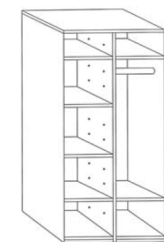

Right (WDR)
Add \$158 list

Configuration	Quick Model	Quick Size	Adj. Selves	Size	Fluted-L	Concord-L	Carton	B-Weight	Cube
Bookcase									
	BC	A	1	12x36x29	619	693	116	72	11
	BC	B	1	12x36x36	668	787	116	90	14
	BC	C	2	12x36x42	718	909	116	100	16
	BC	D	2	12x36x48	767	1,029	116	110	18
	BC	E	3	12x36x60	817	1,152	116	140	22
	BC	F	3	12x36x66	868	1,274	116	150	24
	BC	G	4	12x36x72	914	1,396	116	170	26
	BC	H	4	12x36x78	965	1,519	116	182	28
	BC	I	5	12x36x84	1,014	1,641	116	200	30

Bookcase Hinged Doors									
	BCH	A	1	14x36x60	1,374	1,715	218	140	22
	BCH	B	1	14x36x66	1,421	1,833	218	155	24
	BCH	C	2	14x36x72	1,472	1,952	218	170	28
	BCH	D	2	14x36x78	1,520	2,071	218	185	30
	BCH	E	3	14x36x84	1,571	2,190	218	200	32
	BCH	F	1	20x36x60	1,696	2,059	218	177	25
	BCH	G	1	20x36x66	1,767	2,201	218	188	28
	BCH	H	2	20x36x72	1,841	2,349	218	203	30
	BCH	I	2	20x36x78	1,917	2,492	218	218	33
	BCH	J	3	20x36x84	1,990	2,638	218	233	35

Bookcase Full Hinged									
	BCW	A	3	14x36x60	1,927	2,308	218	185	22
	BCW	B	3	14x36x66	1,977	2,426	218	195	24
	BCW	C	4	14x36x72	2,026	2,543	218	220	26
	BCW	D	4	14x36x78	2,076	2,663	218	235	28
	BCW	E	5	14x36x84	2,126	2,782	218	255	30
	BCW	F	3	20x36x60	2,323	2,652	218	218	25
	BCW	G	3	20x36x66	2,360	2,794	218	228	28
	BCW	H	4	20x36x72	2,397	2,939	218	253	30
	BCW	I	4	20x36x78	2,470	3,085	218	268	33
	BCW	J	5	20x36x84	2,543	3,228	218	288	35

Bookcase Lateral File									
	BCL	A	1	20x36x60	2,345	2,752	218	275	28
	BCL	B	1	20x36x66	2,396	2,871	218	300	30
	BCL	C	2	20x36x72	2,445	2,988	218	330	32
	BCL	D	2	20x36x78	2,494	3,107	218	350	34
	BCL	E	3	20x36x84	2,545	3,225	218	370	38

Bookcase Hinged Doors/Lateral File									
	BC5	A	1	20x36x60	2,897	3,343	218	275	28
	BC5	B	1	20x36x66	2,947	3,463	218	300	30
	BC5	C	2	20x36x72	2,998	3,577	218	330	32
	BC5	D	2	20x36x78	3,046	3,695	218	350	34
	BC5	E	3	20x36x84	3,094	3,812	218	370	38

TABLE OF CONTENTS

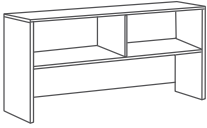
Configuration	Quick Model	Quick Size	Size	Fluted-L	Concord-L	Carton	B-Weight	Cube
Hutch Open								
	H0	A	14x33x37	979	1,074	76	110	15
	H0	B	14x45x37	1,033	1,132	86	120	18
	H0	C	14x57x37	1,138	1,247	100	130	22
	H0	D	14x63x37	1,192	1,307	111	135	25
	H0	E	14x69x37	1,245	1,363	120	145	28
	H0	F	14x75x37	1,347	1,478	132	160	31

FLUTED-L

Edge also included in pricing:
Saga-L

CONCORD-L

Edge also included in pricing:
Victory-L

NOTE

High profile furniture should be anchored to the credenza or desk top with provided dowels or metal brackets

Hutches have 20" clearance from the fixed shelf to the work surface, and a 2" gap for wire management

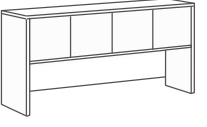
Hutch Hinged Doors								
	H1	A	14x33x37	1,138	1,247	76	120	15
	H1	B	14x45x37	1,256	1,377	86	130	18
	H1	C	14x57x37	1,347	1,478	100	140	22
	H1	D	14x63x37	1,402	1,537	111	145	25
	H1	E	14x69x37	1,452	1,595	120	155	28
	H1	F	14x75x37	1,559	1,709	132	170	31

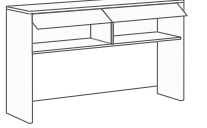
Hutch Garage Doors								
	H2	A	15x33x37	1,233	1,351	76	120	15
	H2	B	15x45x37	1,422	1,559	86	130	18
	H2	C	15x57x37	1,527	1,676	100	140	22
	H2	D	15x63x37	1,581	1,733	111	145	25
	H2	E	15x69x37	1,634	1,790	120	155	28
	H2	F	15x75x37	1,739	1,906	132	170	31

TASK LIGHTS

23" Silver Metal: \$232 list

GLASS DOORS

Frosted Glass Doors (set of 2):
\$331 list

Not available for H2 and H5 hutches

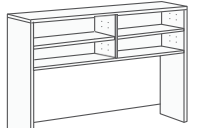
Hutch Open w/Adjustable Shelves								
	H3	A	14x33x42	1,100	1,208	76	115	16
	H3	B	14x45x42	1,154	1,266	86	125	19
	H3	C	14x57x42	1,259	1,381	100	135	23
	H3	D	14x63x42	1,313	1,439	111	150	27
	H3	E	14x69x42	1,366	1,498	120	165	31
	H3	F	14x75x42	1,470	1,610	132	140	34

MAIL SORTER

Add \$182 list for mail sorter

Will reduce clearance from work surface by 5"

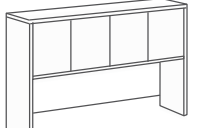
Hutch Hinged Doors w/Adjustable Shelves								
	H4	A	14x33x42	1,419	1,573	76	125	16
	H4	B	14x45x42	1,486	1,627	86	135	19
	H4	C	14x57x42	1,592	1,748	100	145	23
	H4	D	14x63x42	1,646	1,805	111	150	27
	H4	E	14x69x42	1,699	1,862	120	160	31
	H4	F	14x75x42	1,804	1,979	132	175	34

HINGED DOOR

H1A, H1B, H4A, and H4B come with 2 hinged doors; all others come with 4 hinged doors

TACKBOARDS

See page #26 for tackboards

GARAGE DOOR

H2A, H2B, H5A, and H5B come with 1 garage door; all others come with 2 garage doors

TABLE OF CONTENTS

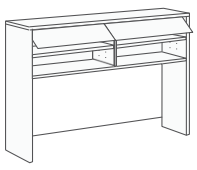
Configuration	Quick Model	Quick Size	Size	Fluted-L	Concord-L	Carton	B-Weight	Cube
Hutch Garage Doors w/Adjustable Shelves								
	H5	A	15x33x42	1,596	1,751	76	125	16
	H5	B	15x45x42	1,649	1,811	86	135	19
	H5	C	15x57x42	1,754	1,925	100	145	23
	H5	D	15x63x42	1,808	1,983	111	150	27
	H5	E	15x69x42	1,860	2,041	120	160	31
	H5	F	15x75x42	1,966	2,156	132	175	34

FLUTED-L

Edge also included in pricing:
Saga-L

CONCORD-L

Edge also included in pricing:
Victory-L

NOTE

High profile furniture should be anchored to the credenza or desk top with provided dowels or metal brackets

Hutches have 20" clearance from the fixed shelf to the work surface, and a 2" gap for wire management

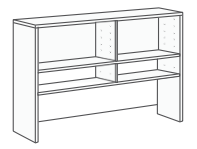
Hutch Hinged Doors w/Fixed Shelf								
	H6	A	14x33x49	1,207	1,322	77	120	18
	H6	B	14x45x49	1,282	1,408	88	130	21
	H6	C	14x57x49	1,433	1,571	101	140	24
	H6	D	14x63x49	1,508	1,655	114	145	28
	H6	E	14x69x49	1,583	1,737	122	155	32
	H6	F	14x75x49	1,692	1,853	135	170	36

Hutch Hinged Doors w/Fixed Shelf								
	H7	A	14x33x49	1,531	1,677	77	130	18
	H7	B	14x45x49	1,605	1,761	88	140	21
	H7	C	14x57x49	1,756	1,925	101	150	24
	H7	D	14x63x49	1,808	1,983	114	155	28
	H7	E	14x69x49	1,907	2,091	122	165	32
	H7	F	14x75x49	2,014	2,208	135	180	36

TASK LIGHTS

23" Silver Metal: \$232 list

GLASS DOORS

Frosted Glass Doors (set of 2):
\$331 list

Not available for H8 hutch

MAIL SORTER

Add \$182 list for mail sorter

Will reduce clearance from work surface by 5"

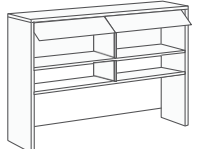
Hutch Garage Doors w/Fixed Shelf								
	H8	A	15x33x49	1,713	1,877	77	130	18
	H8	B	15x45x49	1,787	1,961	88	140	21
	H8	C	15x57x49	1,939	2,123	101	150	24
	H8	D	15x63x49	2,014	2,208	114	155	28
	H8	E	15x69x49	2,088	2,289	122	165	32
	H8	F	15x75x49	2,195	2,408	135	180	36

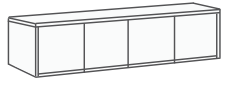
Wall-Mount Overhead								
	H9	A	15x36x15	1,246	1,364	86	62	5
	H9	B	15x48x15	1,434	1,574	100	84	7
	H9	C	15x60x15	1,722	1,888	111	106	8
	H9	D	15x66x15	1,819	1,994	120	117	9
	H9	E	15x72x15	1,913	2,099	132	128	10
	H9	F	15x78x15	2,202	2,412	142	140	11

HINGED DOOR

H7A, H7B, H9A, and H9B come with 2 hinged doors; all others come with 4 hinged doors

WALL-MOUNT OVERHEAD

Licensed installers are recommended to install wall-mounted furniture. Installers must provide fasteners.

WALL-MOUNT OVERHEAD

Add \$339 list for garage doors

TACKBOARDS

See page #26 for tackboards



GARAGE DOOR

H8A, H8B, H9A, and H9B come with 1 garage door; all others come with 2 garage doors

[Back to main Table of Contents](#)

Click text to jump page

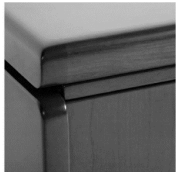
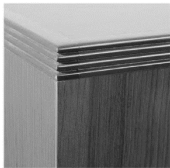
SERIES

pg. 211	<u>ARISTOCRAT</u>	 (A)	Included in pricing: BEVELED, SQUARE, MATRIX
pg. 211	<u>ROW</u>	 (R)	Included in pricing: ROW 2, ROW-BEVELED, ROW-REVERSE-BEVELED, ROW-FLUTED*, ROW- SAGA* <small>*Upcharge</small>
pg. 234	<u>FLUTED-V</u>	 (FV)	Included in pricing: SAGA-V
pg. 234	<u>CONCORD-V</u>	 (CV)	Included in pricing: VICTORY-V

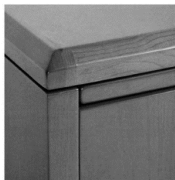

BEVELED
(BV)



SQUARE
(QV)



MATRIX
(MV)



ROW 2
(R2)

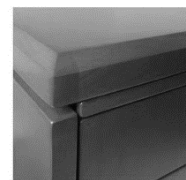

ROW-BEVELED
(RB)

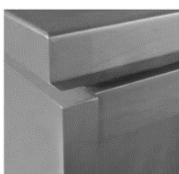

ROW-REVERSED-
BEVELED
(RRB)

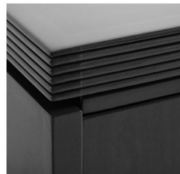

ROW-FLUTED
(RF)



ROW-SAGA
(RS)



SAGA-V
(SV)



VICTORY-V
(VV)

TABLE OF CONTENTS

WOOD VENEER
ARISTOCRAT & ROW

TABLE OF CONTENTS

Click text to jump page





<i>pg. 212</i>	<u>DESKS</u>	
<i>pg. 216</i>	<u>DESK UNITS</u>	
<i>pg. 222</i>	<u>BRIDGES/RETURNS</u>	
<i>pg. 224</i>	<u>CREDENZAS</u>	
<i>pg. 228</i>	<u>FILES/STORAGE</u>	
<i>pg. 231</i>	<u>BOOKCASES</u>	
<i>pg. 232</i>	<u>HUTCHES</u>	

TABLE OF CONTENTS

Configuration	Quick Model	Quick Size	Size	Aristocrat	Row	Carton	B-Weight	Cube
Desk Shell No Ped ¾ Modesty – add \$210 for Full (FM)								
	S	A	24x48	1,824	2,088	101	102	24
	S	B	24x60	1,929	2,198	135	120	30
	S	C	24x66	2,037	2,306	135	125	32
	S	D	24x72	2,037	2,306	135	135	35
	S	E	30x48	1,824	2,144	135	120	28
	S	F	30x60	1,824	2,144	135	140	36
	S	G	30x66	2,037	2,144	135	148	35
	S	H	30x72	2,037	2,360	135	154	42
	S	I	36x72	2,144	2,521	135	180	50
	S	J	36x78	2,360	2,733	179	190	54

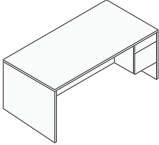
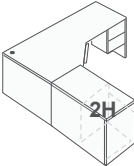
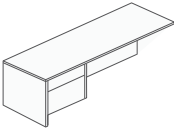
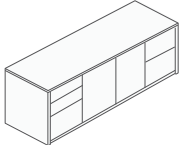
ARISTOCRAT
Edge also included in pricing:
Beveled, Square,
Matrix

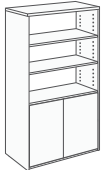
ROW
Edge also included in pricing:
Row 2, Row-Beveled,
Row-Reverse-Beveled

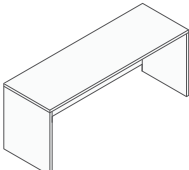
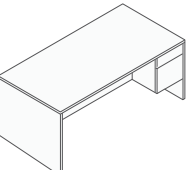
Desk Single ¾ Ped ¾ Modesty – add \$210 for Full (FM)								
	S3	A	24x48	2,360	2,629	101	150	24
	S3	B	30x48	2,360	2,681	101	170	24
	S3	C	30x60	2,360	2,681	135	185	28
	S3	D	30x66	2,573	2,681	179	195	30
	S3	E	30x72	2,573	2,895	101	205	24
	S3	F	36x72	2,681	3,055	135	230	30
	S3	G	36x78	2,896	3,273	179	240	32

FAN TOP

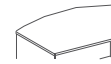

6" fan top (FT)

Aristocrat: add \$728 list
Row: add \$1,091 list

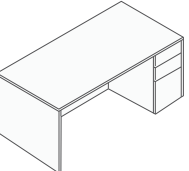
Desk Single Full Ped Full Modesty								
	FP	A	24x48	2,530	2,800	135	160	28
	FP	B	30x48	2,530	2,853	135	170	32
	FP	C	30x60	2,530	2,853	135	190	40
	FP	D	30x66	2,747	2,853	135	210	44
	FP	E	30x72	2,853	3,228	135	230	48
	FP	F	36x72	2,853	3,228	179	250	54
	FP	G	36x78	3,067	3,442	179	280	58

RIGHT OR LEFT
Specify (RP) for Right Pedestal or
(LP) for Left Pedestal

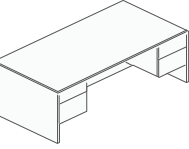
Desk Double ¾ Ped ¾ Modesty – add \$210 for Full (FM)								
	D3	A	30x60	2,895	3,216	135	232	36
	D3	B	30x66	3,111	3,216	135	242	40
	D3	C	30x72	3,111	3,431	135	250	44
	D3	D	36x72	3,216	3,592	135	270	50
	D3	E	36x78	3,431	3,807	179	285	54

ROW-FLUTED

Add \$279 list

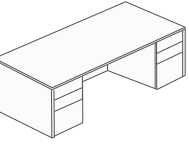
Desk Double Full Ped Full Modesty								
	DF	A	30x60	3,237	3,560	135	290	36
	DF	B	30x66	3,452	3,560	135	300	40
	DF	C	30x72	3,452	3,776	135	310	42
	DF	D	36x72	3,560	3,937	135	330	50
	DF	E	36x78	3,776	4,149	179	340	54

ROW-SAGA

Add \$279 list

TABLE OF CONTENTS

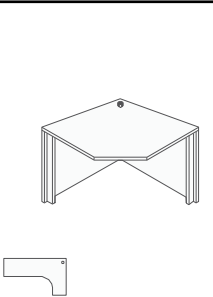
Configuration	Quick Model	Quick Size	Size	Aristocrat	Row	Carton	B-Weight	Cube
Computer Desk Corner Table								
	CCT	A	20-30x30	1,372	1,585	135	80	20
	CCT	B	20-36x36	1,478	1,696	135	100	25
	CCT	C	20-42x42	1,585	1,804	135	124	35
	CCT	D	20-48x48	1,696	1,911	135	150	45
	CCT	E	24-36x36	1,804	2,018	135	110	30
	CCT	F	24-42x42	2,018	2,230	135	120	35
	CCT	G	24-48x48	2,230	2,445	135	155	42

ARISTOCRAT
Edge also included in pricing:
Beveled, Square,
Matrix

ROW
Edge also included in pricing:
Row 2, Row-Beveled,
Row-Reverse-Beveled

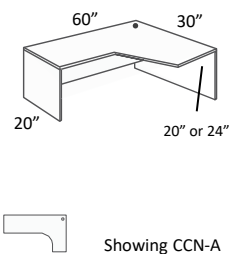
Computer Desk No Ped ¾ Modesty – add \$210 for Full (FM)								
	CCN	A	20-60x30	2,250	2,573	135	184	36
	CCN	B	20-66x30	2,465	2,704	135	192	40
	CCN	C	20-72x30	2,465	2,704	135	210	44
	CCN	D	20-78x30	2,680	3,003	179	230	60
	CCN	E	24-66x36	2,624	2,949	135	200	46
	CCN	F	24-72x36	2,572	2,948	135	210	50
	CCN	G	24-78x36	2,788	3,163	179	230	60
	CCN	H	30-66x42	2,861	3,163	135	250	54
	CCN	I	30-72x42	2,894	3,163	135	260	60
	CCN	J	30-78x42	3,003	3,271	179	272	64
	CCN	K	36-72x48	3,109	3,378	135	285	68
	CCN	L	36-78x48	3,215	3,483	179	300	70

FAN TOP



6" fan top (FT)

Aristocrat: add \$728 list
Row: add \$1,091 list

RADIAL CORNER



Radial corner (RC)

Aristocrat: add \$206 list
Row: add \$303 list

RIGHT OR LEFT

Specify (RP) for Right Pedestal or
(LP) for Left Pedestal

ROW-FLUTED

Add \$279 list

ROW-SAGA

Add \$279 list

NOTE

Black grommet standard

Computer Desk ¾ Ped ¾ Modesty – add \$210 for Full (FM)								
	CCS	A	20-60x30	2,789	3,111	135	220	36
	CCS	B	20-66x30	3,005	3,111	135	230	40
	CCS	C	20-72x30	3,005	3,326	135	242	42
	CCS	D	20-78x30	3,217	3,538	179	260	46
	CCS	E	24-66x36	3,111	3,485	135	230	46
	CCS	F	24-72x36	3,111	3,485	135	250	52
	CCS	G	24-78x36	3,326	3,700	179	260	56
	CCS	H	30-66x42	3,432	3,700	135	250	52
	CCS	I	30-72x42	3,432	3,700	135	260	56
	CCS	J	30-78x42	3,538	3,805	179	275	60
	CCS	K	36-72x48	3,646	3,915	135	275	60
	CCS	L	36-78x48	3,754	4,149	179	285	64

TABLE OF CONTENTS

Configuration	Quick Model	Quick Size	Size	Aristocrat	Row	Carton	B-Weight	Cube
Computer Desk Full Ped Full Modesty								
	CDF	A	20-60x30	2,959	3,282	135	190	36
	CDF	B	20-66x30	3,175	3,282	135	200	40
	CDF	C	20-72x30	3,175	3,496	135	225	50
	CDF	D	20-78x30	3,390	3,711	179	235	54
	CDF	E	24-66x36	3,282	3,659	135	245	46
	CDF	F	24-72x36	3,282	3,659	135	255	50
	CDF	G	24-78x36	3,496	3,872	179	265	54
	CDF	H	30-66x42	3,602	3,872	135	265	54
	CDF	I	30-72x42	3,602	3,872	135	275	60
	CDF	J	30-78x42	3,711	3,978	179	285	64
	CDF	K	36-72x48	3,818	4,086	135	300	68
	CDF	L	36-78x48	4,052	4,320	179	320	72

ARISTOCRAT
Edge also included in pricing:
Beveled, Square,
Matrix

ROW
Edge also included in pricing:
Row 2, Row-Beveled,
Row-Reverse-Beveled

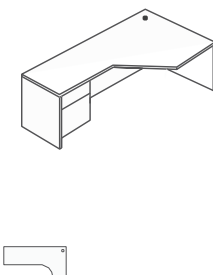
Configuration	Quick Model	Quick Size	Size	Aristocrat	Row	Carton	B-Weight	Cube
Computer Desk Lateral File w/Black Pulls Full Modesty								
	DL	A	20-72x30	3,754	4,077	135	230	44
	DL	B	20-78x30	3,968	4,289	179	240	48
	DL	C	24-72x36	3,861	4,235	135	255	50
	DL	D	24-78x36	4,077	4,451	179	265	54
	DL	E	30-72x42	4,182	4,451	135	265	60
	DL	F	30-78x42	4,451	4,560	179	305	64
	DL	G	36-72x48	4,289	4,666	135	320	68
	DL	H	36-78x48	4,632	4,901	179	340	72

FAN TOP



6" fan top (FT)
Aristocrat: add \$728 list
Row: add \$1,091 list

RADIAL CORNER



Radial corner (RC)
Aristocrat: add \$206 list
Row: add \$303 list

Configuration	Quick Model	Quick Size	Size	Aristocrat	Row	Carton	B-Weight	Cube
Computer Desk Personal Lateral File w/Black Pulls Full Modesty								
	CP	A	20-72x30	4,077	4,398	135	238	44
	CP	B	20-78x30	4,289	4,610	179	248	48
	CP	C	24-72x36	4,182	4,560	135	273	50
	CP	D	24-78x36	4,400	4,774	179	263	54
	CP	E	30-72x42	4,504	4,774	135	293	60
	CP	F	30-78x42	4,611	4,879	179	313	64
	CP	G	36-72x48	4,718	4,987	135	328	68
	CP	H	36-78x48	4,957	5,221	179	348	72

RIGHT OR LEFT
Specify (RP) for Right Pedestal or
(LP) for Left Pedestal

ROW-FLUTED

Add \$279 list

ROW-SAGA

Add \$279 list

NOTE

Black grommet standard

TABLE OF CONTENTS

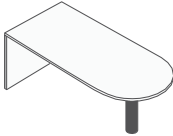
Configuration	Quick Model	Quick Size	Size	Aristocrat	Row	Carton	B-Weight	Cube
Bullet Desk No Ped ¾ Modesty – add \$210 for Full (FM)								
	BN	A	30x60	2,573	2,895	135	130	36
	BN	B	30x66	2,789	3,111	135	154	42
	BN	C	30x72	2,789	3,111	135	145	43
	BN	D	36x72	2,895	3,216	135	165	50
	BN	E	36x78	3,111	3,431	179	200	64
	BN	F	42x84	3,325	3,645	179	220	68

ARISTOCRAT
Edge also included in pricing:
Beveled, Square,
Matrix

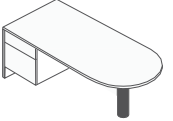
Configuration	Quick Model	Quick Size	Size	Aristocrat	Row	Carton	B-Weight	Cube
Bullet Desk ¾ Ped ¾ Modesty – add \$210 for Full (FM)								
	BS	A	30x60	3,111	3,431	135	235	42
	BS	B	30x66	3,325	3,645	135	235	42
	BS	C	30x72	3,325	3,645	135	245	50
	BS	D	36x72	3,431	3,754	179	265	54
	BS	E	36x78	3,645	3,968	179	275	64
	BS	F	42x84	3,861	4,182	179	285	68

ROW
Edge also included in pricing:
Row 2, Row-Beveled,
Row-Reverse-Beveled

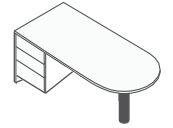
Configuration	Quick Model	Quick Size	Size	Aristocrat	Row	Carton	B-Weight	Cube
Bullet Desk Full Ped Full Modesty								
	BF	A	30x60	3,281	3,602	133	230	38
	BF	B	30x66	3,496	3,818	133	240	40
	BF	C	30x72	3,496	3,818	133	250	40
	BF	D	36x72	3,602	3,925	133	265	42
	BF	E	36x78	3,818	4,139	178	275	46
	BF	F	42x84	4,034	4,354	179	310	50

NOTE
BN model not intended for sale as
free standing desk. See bridges
and returns.

POST
Standard in black

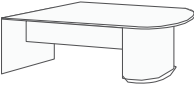
Configuration	Quick Model	Quick Size	Size	Aristocrat	Row	Carton	B-Weight	Cube
Bullet Desk ½ Cylinder Desk No Ped add \$210 for Full Modesty (FM)								
	BCN	A	30x60	3,216	3,538	135	255	42
	BCN	B	30x66	3,431	3,754	135	270	44
	BCN	C	30x72	3,431	3,754	135	270	44
	BCN	D	36x72	3,538	3,861	135	285	48
	BCN	E	36x78	3,754	4,077	179	310	60
	BCN	F	42x84	3,968	4,289	179	330	64

Available in silver, add \$32 list

RIGHT OR LEFT
Specify (RP) for Right Pedestal or
(LP) for Left Pedestal

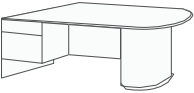
Configuration	Quick Model	Quick Size	Size	Aristocrat	Row	Carton	B-Weight	Cube
Bullet Desk ¾ Ped ¾ Modesty – add \$210 for Full (FM)								
	BCS	A	30x60	3,754	4,077	135	260	40
	BCS	B	30x66	3,968	4,289	135	280	42
	BCS	C	30x72	3,968	4,289	135	300	44
	BCS	D	36x72	4,077	4,398	135	320	44
	BCS	E	36x78	4,289	4,610	179	340	52
	BCS	F	42x84	4,503	4,828	179	350	64

ROW-FLUTED
Add \$279 list

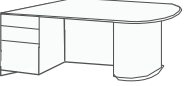
Configuration	Quick Model	Quick Size	Size	Aristocrat	Row	Carton	B-Weight	Cube
Bullet Desk Full Ped Full Modesty								
	BCF	A	30x60	3,925	4,247	135	270	42
	BCF	B	30x66	4,139	4,460	135	270	44
	BCF	C	30x72	4,139	4,460	135	310	46
	BCF	D	36x72	4,247	4,568	135	320	48
	BCF	E	36x78	4,460	4,783	179	340	54
	BCF	F	42x84	4,673	4,998	179	360	64

ROW-SAGA
Add \$279 list

TABLE OF CONTENTS

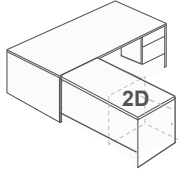
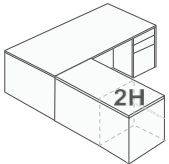
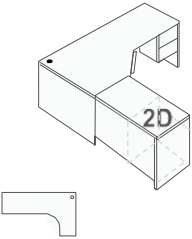
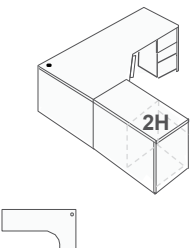
Configuration	Quick Model	Quick Size	Size	Aristocrat	Row	Carton	B-Weight	Cube
L-Shaped Desk ¾ Ped ¾ Modesty – add \$420 for Full (FM)								
	D	1	30x66 Desk 24x42 Return	4,774	5,320	240	300	64
	D	2	36x72 Desk 24x48 Return	4,986	5,459	240	355	75
L-Shaped Desk Full Ped Full Modesty								
	D	3	36x72 Desk 24x48 Return	5,031	5,922	229	410	75
L-Shaped Computer Desk ¾ Ped ¾ Modesty – add \$420 for Full (FM)								
	D	4	36-72x48 Desk 24x48 Return	5,951	6,434	305	340	75
L-Shaped Computer Desk Full Ped Full Modesty								
	D	5	36-72x48 Desk 24x48 Return	6,293	6,777	305	367	75

ARISTOCRAT

Edge also included in pricing:
Beveled, Square,
Matrix

ROW

Edge also included in pricing:
Row 2, Row-Beveled,
Row-Reverse-Beveled

FAN TOP

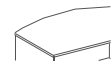

6" fan top (FT)

Aristocrat: add \$728 list
Row: add \$1,091 list

RADIAL CORNER



Radial corner (RC)

Aristocrat: add \$206 list
Row: add \$303 list

RIGHT OR LEFT

Specify (R) for Right Return or
(L) for Left Return

ROW-FLUTED

Add \$558 list

ROW-SAGA

Add \$558 list

NOTE

Black grommet are standard on
Computer Desk

TABLE OF CONTENTS

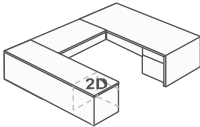
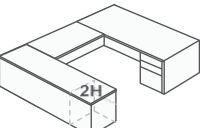
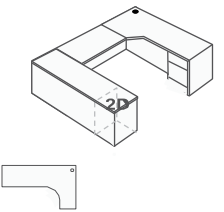
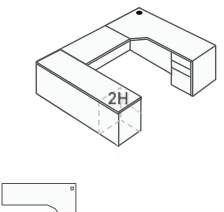
Configuration	Quick Model	Quick Size	Size	Aristocrat	Row	Carton	B-Weight	Cube
U-Shaped Desk ¾ Ped ¾ Modesty – add \$420 for Full (FM)								
	D	6	36X72 Desk 24x48 Bridge 24x72 Credenza	6,863	7,668	346	455	98
U-Shaped Desk Full Ped Full Modesty								
	D	7	36X72 Desk 24x48 Bridge 24x72 Credenza	7,314	8,118	346	580	115
U-Shaped Computer Desk ¾ Ped ¾ Modesty – add \$420 for Full (FM)								
	D	8	30-72x42 Desk 24x48 Bridge 24x72 Credenza	7,505	8,203	346	455	98
U-Shaped Computer Desk Full Ped Full Modesty								
	D	9	30-72x42 Desk 24x48 Bridge 24x72 Credenza	7,956	8,655	346	580	115

ARISTOCRAT

Edge also included in pricing:
Beveled, Square,
Matrix

ROW

Edge also included in pricing:
Row 2, Row-Beveled,
Row-Reverse-Beveled

FAN TOP



6" fan top (FT)

Aristocrat: add \$728 list
Row: add \$1,091 list

RADIAL CORNER



Radial corner (RC)

Aristocrat: add \$206 list
Row: add \$303 list

RIGHT OR LEFT

Specify (R) for Right Bridge or
(L) for Left Bridge

ROW-FLUTED

Add \$850 list

ROW-SAGA

Add \$850 list

NOTE

Black grommet are standard on
Computer Desk

TABLE OF CONTENTS

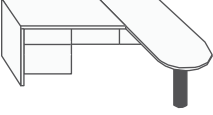
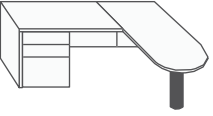
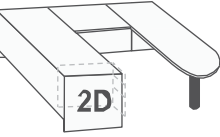
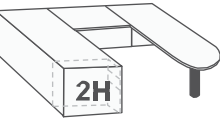
Configuration	Quick Model	Quick Size	Size	Aristocrat	Row	Carton	B-Weight	Cube
L-Shaped Bullet Desk ¾ Ped ¾ Modesty – add \$420 for Full (FM)								
	D	10	36X72 Desk 24x48 Return	5,199	5,736	225	290	68
L-Shaped Bullet Desk Full Ped Full Modesty								
	D	11	36X72 Desk 24x48 Return	5,374	5,909	225	315	72
U-Shaped Bullet Desk ¾ Ped ¾ Modesty – add \$420 for Full (FM)								
	D	12	36x72 Desk 24x48 Bridge 24x72 Credenza	7,079	7,829	330	555	96
U-Shaped Bullet Desk Full Ped Full Modesty								
	D	13	36x72 Desk 24x48 Bridge 24x72 Credenza	7,250	8,000	330	583	96

ARISTOCRAT
Edge also included in pricing:
Beveled, Square,
Matrix

ROW
Edge also included in pricing:
Row 2, Row-Beveled,
Row-Reverse-Beveled

POST
Standard in black
Available in silver, add \$32 list

RIGHT OR LEFT
Specify (R) for Right Bridge or (L)
for Left Bridge

ROW-FLUTED
For D10/D11, add \$507 list
For D12/D13, add \$850 list

ROW-SAGA
For D10/D11, add \$558 list
For D12/D13, add \$850 list

TABLE OF CONTENTS

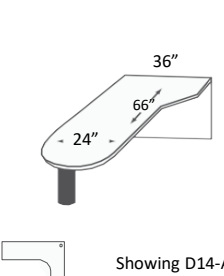
Configuration	Quick Model	Quick Size	Size	Aristocrat	Row	Carton	B-Weight	Cube
Bullet Computer Desk Shell ¾ Modesty – add \$210 for Full (FM)								
 <p>Showing D14-A</p>	D14	A	24-66X36	2,789	3,216	135	125	42
	D14	B	24-72X36	2,895	3,325	135	135	45
	D14	C	24-78X36	3,004	3,431	179	145	48
	D14	D	30-66X42	3,111	3,538	135	145	51
	D14	E	30-72X42	3,216	3,645	135	155	54
	D14	F	30-78X42	3,325	3,754	179	165	57
	D14	G	36-66X48	3,431	3,861	135	165	60
	D14	H	36-72X48	3,538	3,968	135	175	63
	D14	I	36-78X48	3,645	4,077	179	185	66

ARISTOCRAT
Edge also included in pricing:
Beveled, Square,
Matrix

ROW
Edge also included in pricing:
Row 2, Row-Beveled,
Row-Reverse-Beveled

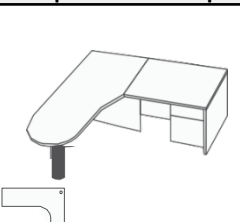
L-Shaped Bullet Computer Desk ¾ Ped ¾ Modesty – add \$420 for Full (FM)								
	D	15	30-72x42 Desk 24x48 Return	5,525	6,167	225	255	78

NOTE
D14 model not intended for sale
as freestanding desk. See bridges
and returns.

RADIAL CORNER

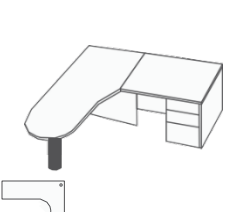

Radial corner (RC)
Aristocrat: add \$206 list
Row: add \$303 list

L-Shaped Bullet Computer Desk Full Ped Full Modesty								
	D	16	30-72x42 Desk 24x48 Return	5,697	6,338	225	285	78

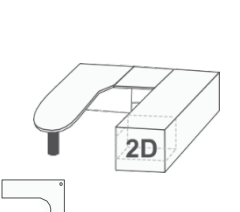
U-Shaped Bullet Computer Desk ¾ Ped ¾ Modesty – add \$420 for Full (FM)								
	D	17	30-72x42 Desk 24x42 Bridge 24x72 Credenza	7,293	8,151	368	465	106

POST
Standard in black
Available in silver, add \$32 list

RIGHT OR LEFT
Specify (R) for Right Bridge or (L)
for Left Bridge

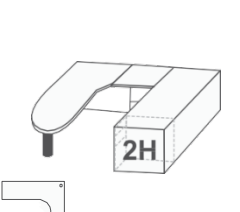
U-Shaped Bullet Computer Desk Full Ped Full Modesty								
	D	18	30-72x42 Desk 24x42 Bridge 24x72 Credenza	7,463	8,323	368	495	106

ROW-FLUTED
For D14, add \$279 list
For D15/D16, add \$558 list
For D17/D18, add \$850 list

ROW-SAGA
For D14, add \$279 list
For D15/D16, add \$558 list
For D17/D18, add \$850 list

TABLE OF CONTENTS

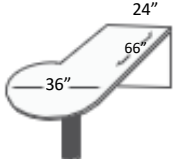
Configuration	Quick Model	Quick Size	Size	Aristocrat	Row	Carton	B-Weight	Cube
P-Shaped Desk Shell ¾ Modesty – add \$210 for Full (FM)								
 <p>Showing D19-A</p>	D19	A	36-66x24	3,055	3,700	135	105	42
	D19	B	36-72x24	3,164	3,807	144	120	45
	D19	C	36-78x24	3,272	3,914	159	135	49
	D19	D	42-66x30	3,379	4,022	144	150	48
	D19	E	42-72x30	3,484	4,127	159	165	53
	D19	F	42-78x30	3,592	4,234	168	180	57
	D19	G	48-66x36	3,700	4,343	159	195	55
	D19	H	48-72x36	3,807	4,450	168	210	60
	D19	I	48-78x36	3,914	4,559	179	225	66

ARISTOCRAT
Edge also included in pricing:
Beveled, Square,
Matrix

ROW
Edge also included in pricing:
Row 2, Row-Beveled,
Row-Reverse-Beveled

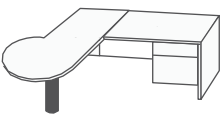
L-Shaped P-Desk ¾ Ped ¾ Modesty – add \$420 for Full (FM)								
	D	20	48-78x36 Desk 24x48 Return	6,221	7,079	269	285	86

NOTE
D19 model not intended for sale
as freestanding desk. See bridges
and returns.

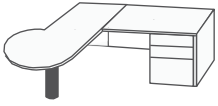
L-Shaped P-Desk Full Ped Full Modesty								
	D	21	48-78x36 Desk 24x48 Return	6,391	7,079	269	298	86

POST
Standard in black
Available in silver, add \$32 list

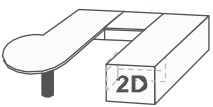
U-Shaped P-Desk ¾ Ped ¾ Modesty – add \$420 for Full (FM)								
	D	22	48-78x36 Desk 24x48 Bridge 24x78 Credenza	8,311	9,382	383	508	119

RIGHT OR LEFT
Specify (R) for Right Bridge or (L)
for Left Bridge

ROW-FLUTED
For D19, add \$279 list
For D20/D21, add \$558 list
For D22/D23, add \$850 list

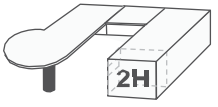
U-Shaped P-Desk Full Ped Full Modesty								
	D	23	48-78x36 Desk 24x48 Bridge 24x78 Credenza	8,482	9,555	402	538	119

ROW-SAGA
For D19, add \$279 list
For D20/D21, add \$558 list
For D22/D23, add \$850 list

TABLE OF CONTENTS

Configuration	Quick Model	Quick Size	Size	Aristocrat	Row	Carton	B-Weight	Cube
P-Shaped Computer Desk Shell ¾ Modesty – add \$210 for Full (FM)								
<p>Showing D24-A</p>	D24	A	36-66x36	4,343	4,986	135	80	80
	D24	B	36-72x36	4,450	5,094	135	106	106
	D24	C	36-78x36	4,666	5,309	179	106	106
	D24	D	42-66x42	4,666	5,309	179	106	106
	D24	E	42-72x42	4,774	5,417	179	106	106
	D24	F	42-78x42	4,986	5,632	225	106	106

ARISTOCRAT
Edge also included in pricing:
Beveled, Square,
Matrix

ROW
Edge also included in pricing:
Row 2, Row-Beveled,
Row-Reverse-Beveled

P-Shaped Computer Desk ¾ Ped ¾ Modesty – add \$420 for Full (FM)								
	D	25	36-78x36 Desk 24x48 Return	6,973	7,829	269	285	86

NOTE
D24 model not intended for sale
as freestanding desk. See bridges
and returns.

P-Shaped Computer Desk Full Ped Full Modesty								
	D	26	36-78x36 Desk 24x48 Return	7,144	8,001	269	298	86

RADIAL CORNER



Radial corner (RC)

Aristocrat: add \$206 list
Row: add \$303 list

U-Shaped P-Desk ¾ Ped ¾ Modesty – add \$420 for Full (FM)								
	D	27	36-78x36 Desk 24x48 Bridge 24x78 Credenza	9,063	10,134	402	508	119

POST
Standard in black

Available in silver, add \$32 list

U-Shaped P-Desk Full Ped Full Modesty								
	D	28	36-78x36 Desk 24x48 Bridge 24x78 Credenza	9,233	10,307	402	538	119

RIGHT OR LEFT
Specify (R) for Right Bridge or (L)
for Left Bridge

ROW-FLUTED
For D24, add \$279 list
For D25/D26, add \$558 list
For D27/D28, add \$850 list

ROW-SAGA
For D24, add \$279 list
For D25/D26, add \$558 list
For D27/D28, add \$850 list

TABLE OF CONTENTS

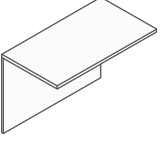
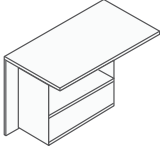
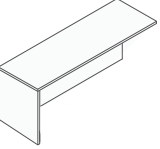
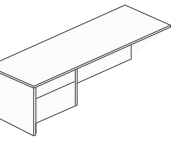
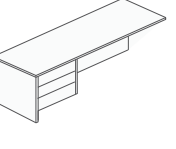
Configuration	Quick Model	Quick Size	Size	Aristocrat	Row	Carton	B-Weight	Cube
Bridge ¾ Mod w/2D Desk or Credenza Full Mod w/3H Desk or Credenza								
	B	A	20x36	1,304	1,508	101	55	15
	B	B	20x42	1,405	1,613	101	60	17
	B	C	20x48	1,508	1,719	101	65	19
	B	D	20x54	1,614	1,821	101	70	21
	B	E	24x36	1,345	1,553	101	60	18
	B	F	24x42	1,448	1,656	101	65	21
	B	G	24x48	1,553	1,760	101	70	24
	B	H	24x54	1,657	1,860	101	75	27
Bridge 12" Deep Bookcase								
	1BB	A	20x36	1,925	2,131	101	90	15
	1BB	B	20x42	2,029	2,233	101	95	17
	1BB	C	20x48	2,131	2,337	101	100	19
	1BB	D	20x54	2,234	2,440	101	105	21
	1BB	E	24x36	1,966	2,173	101	100	18
	1BB	F	24x42	2,069	2,276	101	105	21
	1BB	G	24x48	2,173	2,380	101	115	24
	1BB	H	24x54	2,277	2,484	101	125	27
Return Shell ¾ modesty – add \$210 for Full (FM)								
	R	A	20x36	1,458	1,664	101	55	15
	R	B	20x42	1,561	1,768	101	60	17
	R	C	20x48	1,664	1,874	101	65	19
	R	D	20x54	1,771	1,977	101	70	21
	R	E	24x36	1,501	1,708	101	75	18
	R	F	24x42	1,603	1,808	101	85	21
	R	G	24x48	1,708	1,913	101	60	24
	R	H	24x54	1,809	2,015	101	65	27
Return ¾ Ped (Box/File) ¾ modesty – add \$210 for Full (FM)								
	R2	A	20x36	1,977	2,183	101	75	15
	R2	B	20x42	2,082	2,287	101	80	17
	R2	C	20x48	2,183	2,390	101	85	19
	R2	D	20x54	2,287	2,494	101	90	21
	R2	E	24x36	2,015	2,226	101	80	18
	R2	F	24x42	2,127	2,327	101	85	21
	R2	G	24x48	2,226	2,432	101	100	24
	R2	H	24x54	2,328	2,535	101	115	27
Return ¾ Ped (Box/Box/Box) ¾ modesty – add \$210 for Full (FM)								
	R3	A	20x36	2,093	2,297	101	75	15
	R3	B	20x42	2,193	2,400	101	80	17
	R3	C	20x48	2,272	2,503	101	85	19
	R3	D	20x54	2,378	2,607	101	90	21
	R3	E	24x36	2,106	2,315	101	80	17
	R3	F	24x42	2,311	2,442	101	85	19
	R3	G	24x48	2,340	2,526	101	100	24
	R3	H	24x54	2,442	2,648	101	115	27

ARISTOCRAT
Edge also included in pricing:
Beveled, Square,
Matrix

ROW
Edge also included in pricing:
Row 2, Row-Beveled,
Row-Reverse-Beveled

RIGHT OR LEFT
Specify (R) for Right or (L) for
Left

ROW-FLUTED
Add \$279 list

ROW-SAGA
Add \$279 list

TABLE OF CONTENTS

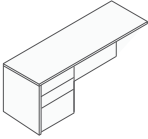
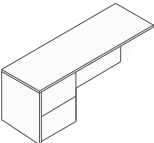
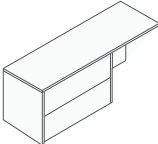
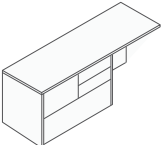
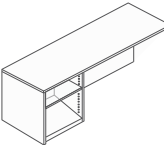
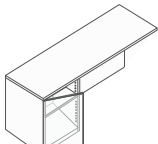
Configuration	Quick Model	Quick Size	Size	Aristocrat	Row	Carton	B-Weight	Cube
Return Full Ped (Box/Box/File) Full Modesty								
	RF	A	20x36	2,205	2,413	101	105	15
	RF	B	20x42	2,311	2,515	101	115	17
	RF	C	20x48	2,413	2,618	101	125	19
	RF	D	20x54	2,515	2,721	101	135	21
	RF	E	24x36	2,246	2,452	101	140	18
	RF	F	24x42	2,349	2,556	101	150	24
	RF	G	24x48	2,452	2,659	101	155	24
	RF	H	24x54	2,556	2,765	101	160	27
Return Full Ped (File/File) Full Modesty								
	RL	A	20x36	2,204	2,413	101	105	15
	RL	B	20x42	2,311	2,515	101	115	17
	RL	C	20x48	2,413	2,618	101	125	19
	RL	D	20x54	2,515	2,721	101	135	21
	RL	E	24x36	2,246	2,452	101	140	18
	RL	F	24x42	2,349	2,556	101	150	21
	RL	G	24x48	2,452	2,659	101	155	24
	RL	H	24x54	2,556	2,765	101	160	27
Return Lateral File w/Standard Black Pulls Full Modesty								
	RLF	A	20x48	2,958	3,169	101	175	19
	RLF	B	20x54	3,063	3,273	101	180	21
	RLF	C	20x60	3,169	3,381	101	185	24
	RLF	D	24x48	3,000	3,213	101	180	24
	RLF	E	24x54	3,105	3,317	101	185	27
	RLF	F	24x60	3,213	3,421	101	190	29
Return Personal Lateral File w/Standard Black Pulls Full Modesty								
	PF	A	20x48	3,277	3,489	101	184	19
	PF	B	20x54	3,381	3,593	101	189	21
	PF	C	20x60	3,489	3,697	101	194	24
	PF	D	24x48	3,320	3,529	101	184	24
	PF	E	24x54	3,423	3,635	101	189	27
	PF	F	24x60	3,529	3,740	101	194	30
Return Personal Printer w/Adjustable Shelf Full Modesty								
	PP	A	20x48	2,392	2,603	101	92	19
	PP	B	20x54	2,496	2,707	101	102	21
	PP	C	20x60	2,603	2,603	101	112	24
	PP	D	24x48	2,435	2,644	101	122	24
	PP	E	24x54	2,539	2,751	101	132	27
	PP	F	24x60	2,644	2,857	101	142	30
Return Personal Printer w/Door Full Modesty								
	PPD	A	20x48	2,656	2,863	101	92	19
	PPD	B	20x54	2,760	2,969	101	102	21
	PPD	C	20x60	2,863	2,863	101	112	24
	PPD	D	24x48	2,697	2,907	101	122	24
	PPD	E	24x54	2,801	3,012	101	132	27
	PPD	F	24x60	2,907	3,119	101	142	30

ARISTOCRAT
Edge also included in pricing:
Beveled, Square,
Matrix

ROW
Edge also included in pricing:
Row 2, Row-Beveled,
Row-Reverse-Beveled

RIGHT OR LEFT
Specify (R) for Right Ped or Left
(L) or Left Ped on credenza
w/single ped

ROW-FLUTED
Add \$279 list

ROW-SAGA
Add \$279 list

TABLE OF CONTENTS

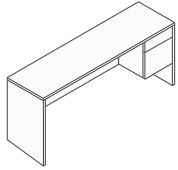
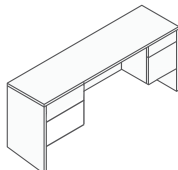
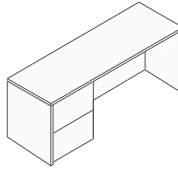
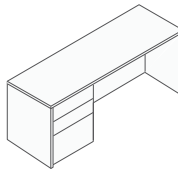
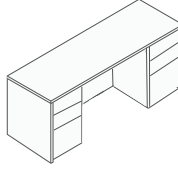
Configuration	Quick Model	Quick Size	Size	Aristocrat	Row	Carton	B-Weight	Cube
Kneespace Credenza ¼ Ped ¾ modesty – add \$210 for Full (FM)								
	C3	A	20x60	2,212	2,423	135	175	22
	C3	B	20x66	2,319	2,530	135	180	26
	C3	C	20x72	2,423	2,635	135	185	28
	C3	D	20x78	2,635	2,846	179	190	30
	C3	E	24x60	2,319	2,530	135	180	26
	C3	F	24x66	2,423	2,635	135	185	28
	C3	G	24x72	2,530	2,741	135	190	30
	C3	H	24x78	2,741	2,954	179	200	32
Kneespace Credenza Double ¼ Ped ¾ modesty – add \$210 for Full (FM)								
	CK	A	20x60	2,789	3,004	135	195	24
	CK	B	20x66	2,895	3,111	135	205	26
	CK	C	20x72	3,004	3,216	135	215	28
	CK	D	20x78	3,111	3,325	179	225	30
	CK	E	24x60	2,895	3,111	135	205	26
	CK	F	24x66	3,004	3,216	135	215	28
	CK	G	24x72	3,111	3,325	135	225	30
	CK	H	24x78	3,216	3,431	179	235	32
Kneespace Credenza Full Ped (File/File) Full Modesty								
	CSP	A	20x60	2,381	2,594	135	182	22
	CSP	B	20x66	2,486	2,700	135	192	26
	CSP	C	20x72	2,594	2,805	135	202	28
	CSP	D	20x78	2,805	3,014	179	212	30
	CSP	E	24x60	2,486	2,700	135	187	26
	CSP	F	24x66	2,594	2,805	135	192	28
	CSP	G	24x72	2,805	3,014	135	222	30
	CSP	H	24x78	2,908	3,120	179	232	32
Kneespace Credenza Full Ped (Box/Box/File) Full Modesty								
	CS3	A	20x60	2,381	2,594	135	182	22
	CS3	B	20x66	2,486	2,700	135	192	26
	CS3	C	20x72	2,594	2,805	135	202	28
	CS3	D	20x78	2,805	3,014	179	212	30
	CS3	E	24x60	2,486	2,700	135	187	26
	CS3	F	24x66	2,594	2,805	135	192	28
	CS3	G	24x72	2,805	3,014	135	222	30
	CS3	H	24x78	2,908	3,120	179	232	32
Kneespace Credenza Double Full Ped Full Modesty								
	CN	A	20x60	3,237	3,452	135	185	24
	CN	B	20x66	3,346	3,560	135	190	26
	CN	C	20x72	3,452	3,666	135	198	28
	CN	D	20x78	3,560	3,776	179	210	30
	CN	E	24x60	3,346	3,560	135	190	26
	CN	F	24x66	3,452	3,666	135	198	28
	CN	G	24x72	3,560	3,776	135	210	30
	CN	H	24x78	3,666	3,883	179	220	32

ARISTOCRAT
Edge also included in pricing:
Beveled, Square,
Matrix

ROW
Edge also included in pricing:
Row 2, Row-Beveled,
Row-Reverse-Beveled

ROW-FLUTED
Add \$279 list

ROW-SAGA
Add \$279 list

TABLE OF CONTENTS

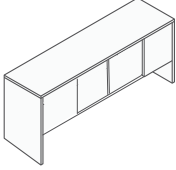
Configuration	Quick Model	Quick Size	Size	Aristocrat	Row	Carton	B-Weight	Cube
Credenza ¾ Storage w/Hinged Doors ¾ modesty – add \$210 for Full (FM)								
	CS	A	20x60	2,895	3,111	135	175	22
	CS	B	20x66	3,111	3,325	135	180	26
	CS	C	20x72	3,216	3,431	135	185	28
	CS	D	20x78	3,325	3,538	179	190	30
	CS	E	24x60	3,004	3,216	135	180	26?
	CS	F	24x66	3,216	3,431	135	185	28
	CS	G	24x72	3,325	3,538	135	190	30
	CS	H	24x78	3,431	3,645	179	200	32

ARISTOCRAT
Edge also included in pricing:
Beveled, Square,
Matrix

ROW
Edge also included in pricing:
Row 2, Row-Beveled,
Row-Reverse-Beveled

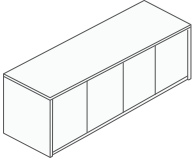
Credenza Full Storage w/Hinged Doors Full Modesty								
	CT	A	20x60	3,538	3,754	135	185	24
	CT	B	20x66	3,645	3,968	135	190	26
	CT	C	20x72	3,754	4,077	135	195	28
	CT	D	20x78	3,861	4,182	179	200	30
	CT	E	24x60	3,645	3,914	135	190	26
	CT	F	24x66	3,754	4,022	135	195	28
	CT	G	24x72	3,861	4,127	135	200	30
	CT	H	24x78	3,968	4,234	179	205	32

ROW-FLUTED

Add \$279 list

ROW-SAGA

Add \$279 list

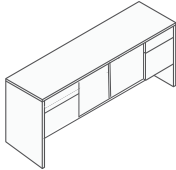
Credenza ¾ Ped w/Hinged Doors ¾ modesty – add \$210 for Full (FM)								
	CA	A	20x60	3,004	3,216	132	220	24
	CA	B	20x66	3,111	3,325	132	225	26
	CA	C	20x72	3,216	3,431	132	230	28
	CA	D	20x78	3,325	3,538	176	240	30
	CA	E	24x60	3,111	3,325	132	225	24
	CA	F	24x66	3,216	3,431	132	230	28
	CA	G	24x72	3,325	3,538	132	235	30
	CA	H	24x78	3,431	3,645	176	245	32

Credenza Full Ped w/Hinged Doors Full Modesty								
	CF	A	20x60	3,883	4,097	135	250	24
	CF	B	20x66	3,989	4,204	135	258	26
	CF	C	20x72	4,097	4,309	135	268	28
	CF	D	20x78	4,204	4,418	179	280	30
	CF	E	24x60	3,989	4,204	135	258	26
	CF	F	24x66	4,097	4,309	135	268	28
	CF	G	24x72	4,204	4,418	135	280	30
	CF	H	24x78	4,309	4,525	179	292	32

TABLE OF CONTENTS

Configuration	Quick Model	Quick Size	Size	Aristocrat	Row	Carton	B-Weight	Cube
Kneespace Credenza Personal Lateral								
	CPK	A	20x72	3,540	3,751	135	228	28
	CPK	B	20x78	3,648	3,865	179	238	30
	CPK	C	24x72	3,757	3,972	135	248	30
	CPK	D	24x78	3,865	4,081	179	258	32

ARISTOCRAT
Edge also included in pricing:
Beveled, Square,
Matrix

Kneespace Credenza Lateral File								
	CL	A	20x72	3,218	3,433	135	220	28
	CL	B	20x78	3,327	3,540	179	230	30
	CL	C	24x72	3,433	3,647	135	240	30
	CL	D	24x78	3,540	3,756	179	250	32

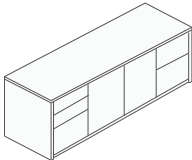
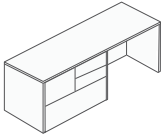
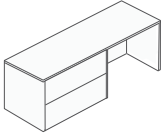
ROW
Edge also included in pricing:
Row 2, Row-Beveled,
Row-Reverse-Beveled

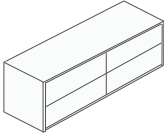
Credenza Double Lateral								
	CDL	A	20x72	3,852	4,066	135	340	28
	CDL	B	24x72	4,066	4,278	135	360	30

RIGHT OR LEFT
Specify (R) for Right Ped or Left
(L) or Left Ped on credenza
w/single ped

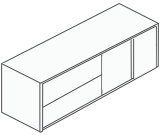
Credenza Lateral/Storage								
	CLS	A	20x72	3,852	4,066	135	306	28
	CLS	B	24x72	4,066	4,278	135	326	30

ROW-FLUTED

Add \$279 list

ROW-SAGA

Add \$279 list

Credenza Personal Lateral/Storage								
	CPL	A	20x72	4,171	4,386	135	316	28
	CPL	B	24x72	4,386	4,596	135	336	30

TABLE OF CONTENTS

Configuration	Quick Model	Quick Size	Size	Aristocrat	Row	Carton	B-Weight	Cube
Buffet Credenza Full Hinged Doors								
	HDHD	A	20x72x36	4,296	4,624	182	230	30
	HDHD	B	24x72x36	4,407	4,715	182	250	36
	HDHD	C	20x78x36	4,589	4,896	218	270	33
	HDHD	D	24x78x36	4,769	5,078	218	290	39

ARISTOCRAT
Edge also included in pricing:
Beveled, Square,
Matrix

Buffet Credenza Hinged Doors & Drawers								
	BBHD	A	20x72x36	5,100	5,424	182	310	30
	BBHD	B	24x72x36	5,207	5,516	182	330	36
	BBHD	C	20x78x36	5,389	5,698	218	350	33
	BBHD	D	24x78x36	5,569	5,879	218	370	39

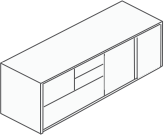
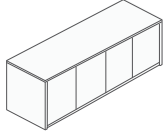
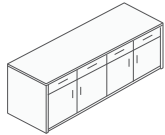
ROW
Edge also included in pricing:
Row 2, Row-Beveled,
Row-Reverse-Beveled

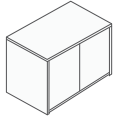
Credenza Hinged Door Storage								
	HD	A	20x36	2,276	2,435	101	180	13
	HD	B	24x36	2,384	2,541	101	190	15
	HD	C	20x36x36	2,509	2,668	126	201	15
	HD	D	24x36x36	2,620	2,779	126	211	18

ROW-FLUTED

Add \$279 list

ROW-SAGA

Add \$279 list





Buffet Credenza Hinged Door Storage w/Drawers								
	BHD	A	20x36x36	2,870	3,030	112	220	15
	BHD	B	24x36x36	2,978	3,138	112	230	18

TABLE OF CONTENTS

Configuration	Quick Model	Quick Size	Size	Aristocrat	Row	Carton	B-Weight	Cube
Lateral File 2 Drawer								
	LF	A	20x36	2,229	2,348	101	178	15
	LF	B	24x36	2,338	2,456	101	192	17
Lateral File 3 Drawer								
	LF3	A	20x36x42	3,346	3,524	162	240	17
	LF3	B	24x36x42	3,507	3,683	162	260	20
Lateral File 4 Drawer								
	LF4	A	20x36x54	4,460	4,694	218	300	22
	LF4	B	24x36x54	4,673	4,911	218	320	26
Personal Lateral File								
	PLF	A	20x36	2,550	2,669	101	188	15
	PLF	B	24x36	2,659	2,776	101	202	17
Vertical File 2 Drawer								
	VF	A	24x18	1,911	2,025	101	140	8
	VF	B	24x21	2,018	2,134	101	150	9
Vertical File 3 Drawer								
	VF3	A	24x18x42	2,865	3,038	162	200	11
	VF3	B	24x21x42	3,027	3,199	162	220	13
Vertical File 4 Drawer								
	VF4	A	24x18x54	3,819	4,053	218	260	15
	VF4	B	24x21x54	4,035	4,267	218	280	17

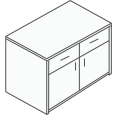
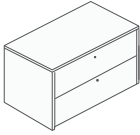
ARISTOCRAT
Edge also included in pricing:
Beveled, Square,
Matrix

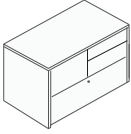
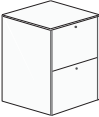
ROW
Edge also included in pricing:
Row 2, Row-Beveled,
Row-Reverse-Beveled

NOTE
High profile furniture should be
anchored to the wall by licensed
installers using own fasteners

One face lock for each drawer
included on file drawers

OPTIONAL GANGLOCK

For 2 Drawer: Add \$109 list

For 3 Drawer: Add \$194 list

For 4 Drawer: Add \$279 list

VERTICAL FILE

A = Letter Size

B = Legal Size



ROW-FLUTED

Add \$279 list

ROW-SAGA

Add \$279 list

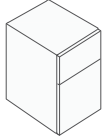
TABLE OF CONTENTS

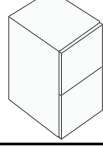
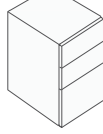
Configuration	Quick Model	Quick Size	Size	Price	Carton	B-Weight	Cube
Free-stand Pedestal Box/File							
	2D	PD	23X16X19.5	749	84	84	6
	2D	PCR	19X16X19.5	749	84	84	6
Free-stand Pedestal Box/Box/Box							
	3D	PD	23X16X19.5	856	97	90	6
	3D	PCR	19X16X19.5	856	97	90	6
Free-stand Pedestal Four Box Drawer							
	4D	PD	23X16X25.5	1,069	97	109	8
	4D	PCR	19X16X25.5	1,069	97	109	8
Free-stand Pedestal File/File							
	2H	PD	23X16X25.5	965	97	99	8
	2H	PCR	19X16X25.5	965	97	99	8
Free-stand Pedestal Box/Box/File							
	3H	PD	23X16X25.5	965	97	99	8
	3H	PCR	19X16X25.5	965	97	99	8

NOTE

Finished peds come with 3/4" top and square edges

All drawers come with ball-bearing suspensions



CASTERS or KICK BASE
Add \$61 list for casters or kick base

Pedestal becomes 2" higher

GANGLOCK or PED-LOCK

Add \$109 list

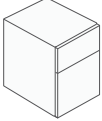
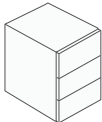
TABLE OF CONTENTS

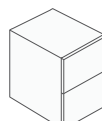
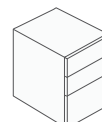
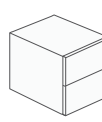
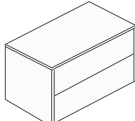
Configuration	Quick Model	Quick Size	Size	Price	Carton	B-Weight	Cube
Hanging Pedestal Box/File							
	2D		23x16x18	645	84	75	4
Hanging Pedestal Box/Box/Box							
	3D		23x16x18	645	84	75	4
Hanging Pedestal Four Box Drawer							
	4D		23x16x24	751	97	100	6
Hanging Pedestal File/File							
	2H		23x16x24	751	97	90	6
Hanging Pedestal Box/Box/File							
	3H		23x16x24	751	97	90	6
Hanging Pedestal – Legal Size File/File							
	2LS		23x20x24	967	97	100	6
Hanging Pedestal Lateral File							
	LF		23x36x24	1,394	87	120	10

NOTE

Hanging pedestals are designed to customize your desk shell, desk, credenza, etc.

All peds are one side finished, unfinished top and back, and field installable

TABLE OF CONTENTS

WARDROBE

Configuration is applicable for 20x36x72 or higher

Use pricing from Full Hinged (BCW-F-3) and up

Smaller size DON'T have Bottom Shelf

For 24" Depth Laminate, add \$166 list
For 24" Veneer, add \$331 list

For Double Face Lock "Installed on top doors", add \$66 list

For Lock Mechanism "Centered Installed", add \$281 list

Black pulls standard where shown

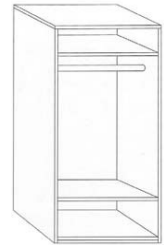

Centered (WD)
Add \$83 list

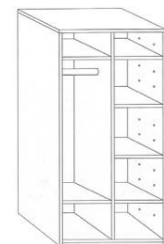

Left (WDL)
Add \$166 list

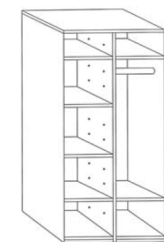

Right (WDR)
Add \$166 list

Configuration	Quick Model	Quick Size	Adj. Selves	Size	Aristocrat	Row	Carton	B-Weight	Cube
	BC	A	1	12x36x29	1,174	1,517	116	72	11
	BC	B	1	12x36x36	1,250	1,719	116	90	14
	BC	C	2	12x36x42	1,324	1,918	116	100	16
	BC	D	2	12x36x48	1,402	2,123	116	110	18
	BC	E	3	12x36x60	1,478	2,324	116	140	22
	BC	F	3	12x36x66	1,551	2,524	116	150	24
	BC	G	4	12x36x72	1,627	2,725	116	170	26
	BC	H	4	12x36x78	1,702	2,926	116	182	28
	BC	I	5	12x36x84	1,779	3,126	116	200	30

Bookcase Hinged Doors									
	BCH	A	1	14x36x60	2,126	2,972	218	140	22
	BCH	B	1	14x36x66	2,202	3,174	218	155	24
	BCH	C	2	14x36x72	2,278	3,375	218	170	28
	BCH	D	2	14x36x78	2,354	3,577	218	185	30
	BCH	E	3	14x36x84	2,429	3,779	218	200	32
	BCH	F	1	20x36x60	2,642	3,572	218	177	25
	BCH	G	1	20x36x66	2,751	3,962	218	188	28
	BCH	H	2	20x36x72	2,847	4,221	218	203	30
	BCH	I	2	20x36x78	2,945	4,471	218	218	33
	BCH	J	3	20x36x84	3,055	4,719	218	233	35

Bookcase Full Hinged									
	BCW	A	3	14x36x60	2,776	3,623	218	185	22
	BCW	B	3	14x36x66	2,851	3,822	218	195	24
	BCW	C	4	14x36x72	2,926	4,025	218	220	26
	BCW	D	4	14x36x78	3,002	4,228	218	235	28
	BCW	E	5	14x36x84	3,078	4,423	218	255	30
	BCW	F	3	20x36x60	3,290	4,221	218	218	25
	BCW	G	3	20x36x66	3,398	4,610	218	228	28
	BCW	H	4	20x36x72	3,499	4,873	218	253	30
	BCW	I	4	20x36x78	3,593	5,119	218	268	33
	BCW	J	5	20x36x84	3,702	5,369	218	288	35

Bookcase Lateral File									
	BCL	A	1	20x36x60	3,424	4,270	218	275	28
	BCL	B	1	20x36x66	3,502	4,472	218	300	30
	BCL	C	2	20x36x72	3,577	4,676	218	330	32
	BCL	D	2	20x36x78	3,651	4,876	218	350	34
	BCL	E	3	20x36x84	3,730	5,078	218	370	38

Bookcase Hinged Doors/Lateral File									
	BC5	A	1	20x36x60	4,074	4,922	218	275	28
	BC5	B	1	20x36x66	4,150	5,121	218	300	30
	BC5	C	2	20x36x72	4,227	5,325	218	330	32
	BC5	D	2	20x36x78	4,302	5,525	218	350	34
	BC5	E	3	20x36x84	4,377	5,726	218	370	38

TABLE OF CONTENTS

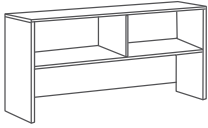
Configuration	Quick Model	Quick Size	Size	Aristocrat	Row	Carton	B-Weight	Cube
Hutch Open								
	H0	A	14x33x37	1,047	1,258	76	110	15
	H0	B	14x45x37	1,208	1,419	86	120	18
	H0	C	14x57x37	1,507	1,718	100	130	22
	H0	D	14x63x37	1,660	1,868	111	135	25
	H0	E	14x69x37	1,803	2,013	120	145	28
	H0	F	14x75x37	1,960	2,169	132	160	31

ARISTOCRAT
Edge also included in pricing:
Beveled, Square,
Matrix

ROW
Edge also included in pricing:
Row 2, Row-Beveled,
Row-Reverse-Beveled

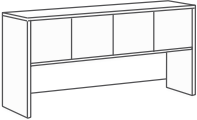
Hutch Hinged Doors								
	H1	A	14x33x37	1,504	1,713	76	120	15
	H1	B	14x45x37	1,722	1,933	86	130	18
	H1	C	14x57x37	2,216	2,427	100	140	22
	H1	D	14x63x37	2,461	2,672	111	145	25
	H1	E	14x69x37	2,709	2,921	120	155	28
	H1	F	14x75x37	2,956	3,166	132	170	31

NOTE
High profile furniture should be anchored to the credenza or desk top with provided dowels or metal brackets

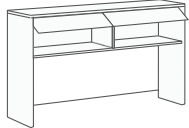
Hutch Garage Doors								
	H2	A	15x33x37	1,612	1,822	76	120	15
	H2	B	15x45x37	1,903	2,110	86	130	18
	H2	C	15x57x37	2,396	2,605	100	140	22
	H2	D	15x63x37	2,643	2,858	111	145	25
	H2	E	15x69x37	2,891	3,099	120	155	28
	H2	F	15x75x37	3,158	3,345	132	170	31

Hutches have 20" clearance from the fixed shelf to the work surface, and a 2" gap for wire management

TASK LIGHTS
23" Silver Metal: \$255list

Hutch Open w/Adjustable Shelves								
	H3	A	14x33x42	1,248	1,458	76	115	16
	H3	B	14x45x42	1,330	1,537	86	125	19
	H3	C	14x57x42	1,660	1,868	100	135	23
	H3	D	14x63x42	1,822	2,033	111	150	27
	H3	E	14x69x42	1,989	2,202	120	165	31
	H3	F	14x75x42	2,156	2,367	132	140	34

GLASS DOORS
Frosted Glass Doors (set of 2):
\$331 list

Not available for H2 and H5 hutches

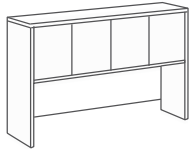
Hutch Hinged Doors w/Adjustable Shelves								
	H4	A	14x33x42	1,610	1,820	76	125	16
	H4	B	14x45x42	1,933	2,144	86	135	19
	H4	C	14x57x42	2,427	2,639	100	145	23
	H4	D	14x63x42	2,672	2,885	111	150	27
	H4	E	14x69x42	2,921	3,133	120	160	31
	H4	F	14x75x42	3,166	3,376	132	175	34

MAIL SORTER
Add \$364 list for mail sorter
Will reduce clearance from work surface by 5"

HINGED DOOR
H1A, H1B, H4A, and H4B come with 2 hinged doors; all others come with 4 hinged doors

TACKBOARDS

See page #26 for tackboards

ROW-SAGA ROW-FLUTED
Add \$279 list Add \$279 list

GARAGE DOOR
H2A, H2B, H5A, and H5B come with 1 garage door; all others come with 2 garage doors

TABLE OF CONTENTS

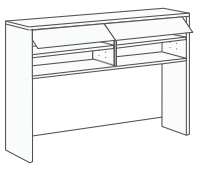
Configuration	Quick Model	Quick Size	Size	Aristocrat	Row	Carton	B-Weight	Cube
Hutch Garage Doors w/Adjustable Shelves								
	H5	A	15x33x42	1,724	1,935	76	125	16
	H5	B	15x45x42	2,110	2,323	86	135	19
	H5	C	15x57x42	2,605	2,816	100	145	23
	H5	D	15x63x42	2,852	3,061	111	150	27
	H5	E	15x69x42	3,099	3,311	120	160	31
	H5	F	15x75x42	3,345	3,556	132	175	34

ARISTOCRAT
Edge also included in pricing:
Beveled, Square,
Matrix

ROW
Edge also included in pricing:
Row 2, Row-Beveled,
Row-Reverse-Beveled

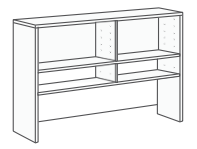
Hutch Open w/Adjustable Shelves								
	H6	A	14x33x49	1,375	1,586	77	120	18
	H6	B	14x45x49	1,475	1,688	88	130	21
	H6	C	14x57x49	1,848	2,061	101	140	24
	H6	D	14x63x49	2,033	2,245	114	145	28
	H6	E	14x69x49	2,223	2,432	122	155	32
	H6	F	14x75x49	2,410	2,621	135	170	36

NOTE
High profile furniture should be anchored to the credenza or desk top with provided dowels or metal brackets

Hutch Hinged Doors w/Fixed Shelf								
	H7	A	14x33x49	1,734	1,945	77	130	18
	H7	B	14x45x49	2,082	2,291	88	140	21
	H7	C	14x57x49	2,617	2,826	101	150	24
	H7	D	14x63x49	2,885	3,095	114	155	28
	H7	E	14x69x49	3,153	3,364	122	165	32
	H7	F	14x75x49	3,418	3,631	135	180	36

Hutches have 20" clearance from the fixed shelf to the work surface, and a 2" gap for wire management

TASK LIGHTS
23" Silver Metal:\$255 list

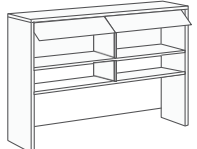
Hutch Garage Doors w/Fixed Shelf								
	H8	A	15x33x49	1,851	2,062	77	130	18
	H8	B	15x45x49	2,260	2,470	88	140	21
	H8	C	15x57x49	2,794	3,004	101	150	24
	H8	D	15x63x49	3,061	3,273	114	155	28
	H8	E	15x69x49	3,333	3,542	122	165	32
	H8	F	15x75x49	3,599	3,808	135	180	36

GLASS DOORS
Frosted Glass Doors (set of 2):
\$331 list

Not available for H8 hutch

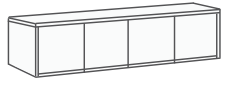
Wall-Mount Overhead								
	H9	A	15x36x15	1,626	1,819	86	62	5
	H9	B	15x48x15	1,913	2,105	100	84	7
	H9	C	15x60x15	2,202	2,391	111	106	8
	H9	D	15x66x15	2,344	2,535	120	117	9
	H9	E	15x72x15	2,486	2,679	132	128	10
	H9	F	15x78x15	2,869	3,059	142	140	11

MAIL SORTER
Add \$364 list for mail sorter
Will reduce clearance from work surface by 5"

HINGED DOOR
H7A, H7B, H9A, and H9B come with 2 hinged doors; all others come with 4 hinged doors

WALL-MOUNT OVERHEAD

Licensed installers are recommended to install wall-mounted furniture. Installers must provide fasteners.

WALL-MOUNT OVERHEAD

Add \$323 list for garage doors

TACKBOARDS

See page #26 for tackboards

ROW-FLUTED

Add \$279 list

ROW-SAGA

Add \$279 list

GARAGE DOOR

H8A, H8B, H9A, and H9B come with 1 garage door; all others come with 2 garage doors

TABLE OF CONTENTS

WOOD VENEER
FLUTED-V & CONCORD-V

TABLE OF CONTENTS

Click text to jump page





<i>pg. 235</i>	<u>DESKS</u>	
<i>pg. 239</i>	<u>DESK UNITS</u>	
<i>pg. 245</i>	<u>BRIDGES/RETURNS</u>	
<i>pg. 247</i>	<u>CREDENZAS</u>	
<i>pg. 251</i>	<u>FILES/STORAGE</u>	
<i>pg. 254</i>	<u>BOOKCASES</u>	
<i>pg. 255</i>	<u>HUTCHES</u>	

TABLE OF CONTENTS

Configuration	Quick Model	Quick Size	Size	Fluted-V	Concord-V	Carton	B-Weight	Cube
Desk Shell No Ped ¾ Modesty – add \$210 for Full (FM)								
	S	A	24x48	2,037	2,117	102	102	24
	S	B	24x60	2,144	2,352	135	120	30
	S	C	24x66	2,250	2,472	135	125	32
	S	D	24x72	2,250	2,472	135	135	35
	S	E	30x48	2,037	2,236	135	120	28
	S	F	30x60	2,037	2,236	135	140	36
	S	G	30x66	2,250	2,472	135	148	35
	S	H	30x72	2,250	2,472	135	154	42
	S	I	36x72	2,360	2,587	135	180	50
	S	J	36x78	2,573	2,822	178	190	54

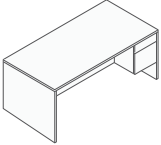
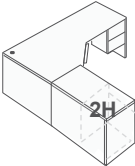
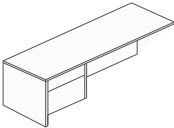
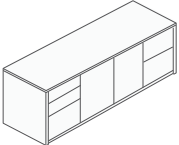
FLUTED-V
Edge also included in pricing:
Saga-V

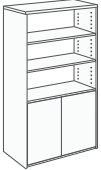
CONCORD-V
Edge also included in pricing:
Victory-V

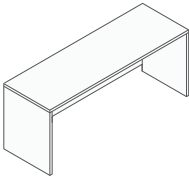
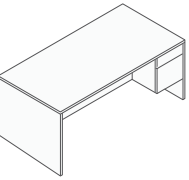
Desk Single ¾ Ped ¾ Modesty – add \$210 for Full (FM)								
	S3	A	24x48	2,573	2,821	102	150	24
	S3	B	30x48	2,573	2,821	102	170	24
	S3	D	30x60	2,573	2,821	135	185	28
	S3	E	30x66	2,789	3,057	178	195	30
	S3	F	30x72	2,789	3,057	102	205	24
	S3	G	36x72	2,895	3,178	135	230	30
	S3	H	36x78	3,111	3,411	178	240	32

FAN TOP

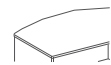

Add \$728 list 6" fan top (FT)

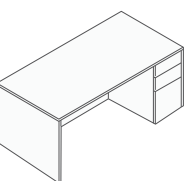
Desk Single Full Ped Full Modesty								
	FP	A	24x48	2,747	3,011	135	160	28
	FP	B	30x48	2,747	3,011	135	170	32
	FP	D	30x60	2,747	3,011	135	190	40
	FP	E	30x66	2,959	3,247	135	210	44
	FP	F	30x72	2,959	3,247	135	230	48
	FP	G	36x72	3,067	3,364	178	250	54
	FP	H	36x78	3,282	3,598	178	280	58

RIGHT OR LEFT
Specify (RP) for Right Pedestal or
(LP) for Left Pedestal

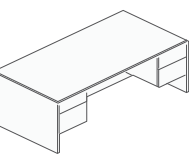
Desk Double ¾ Ped ¾ Modesty – add \$210 for Full (FM)								
	D3	A	30x60	3,111	3,410	135	232	36
	D3	B	30x66	3,325	3,645	135	242	40
	D3	C	30x72	3,325	3,645	135	250	44
	D3	D	36x72	3,431	3,763	135	270	50
	D3	E	36x78	3,646	3,998	178	285	54

Desk Double Full Ped Full Modesty								
	DF	A	30x60	3,451	3,786	135	290	36
	DF	B	30x66	3,666	4,020	135	300	40
	DF	C	30x72	3,666	4,020	135	310	42
	DF	D	36x72	3,777	4,141	135	330	50
	DF	E	36x78	3,989	4,376	178	340	54

TABLE OF CONTENTS

Configuration	Quick Model	Quick Size	Size	Fluted-V	Concord-V	Carton	B-Weight	Cube
Computer Desk Corner Table								
	CCT	A	20-30x30	1,585	1,739	135	80	20
	CCT	B	20-36x36	1,695	1,861	135	100	25
	CCT	C	20-42x42	1,803	1,976	135	124	35
	CCT	D	20-48x48	1,910	2,095	135	150	45
	CCT	E	24-36x36	2,018	2,209	135	110	30
	CCT	F	24-42x42	2,230	2,448	135	120	35
	CCT	G	24-48x48	2,445	2,682	135	155	42

FLUTED-V
Edge also included in pricing:
Saga-V

CONCORD-V
Edge also included in pricing:
Victory-V

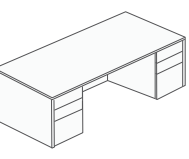
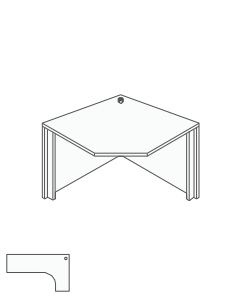
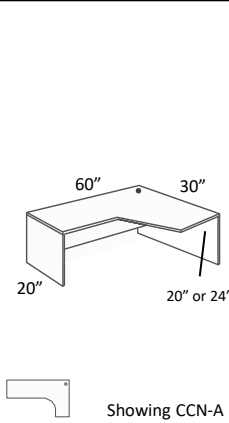
Computer Desk No Ped ¾ Modesty – add \$210 for Full (FM)								
	CCN	A	20-60x30	2,466	2,705	135	184	36
	CCN	B	20-66x30	2,681	2,941	135	192	40
	CCN	C	20-72x30	2,681	2,941	135	210	44
	CCN	D	20-78x30	2,896	3,178	178	230	60
	CCN	E	24-66x36	2,789	3,057	135	200	46
	CCN	F	24-72x36	2,896	3,178	135	210	50
	CCN	G	24-78x36	3,003	3,293	178	230	60
	CCN	H	30-66x42	3,111	3,411	135	250	54
	CCN	I	30-72x42	3,111	3,411	135	260	60
	CCN	J	30-78x42	3,217	3,528	178	272	64
	CCN	K	36-72x48	3,327	3,645	135	285	68
	CCN	L	36-78x48	3,559	3,897	178	300	70

FAN TOP



Add \$728 list for 6" fan top (FT)

RADIAL CORNER

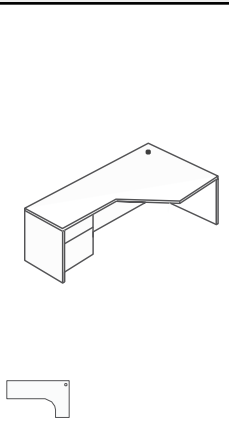

Add \$206 list for radial corner (RC)

Computer Desk ¾ Ped ¾ Modesty – add \$210 for Full (FM)								
	CCS	A	20-60x30	3,005	3,293	135	220	36
	CCS	B	20-66x30	3,217	3,528	135	230	40
	CCS	C	20-72x30	3,215	3,528	135	242	42
	CCS	D	20-78x30	3,430	3,763	178	260	46
	CCS	E	24-66x36	3,327	3,645	135	230	46
	CCS	F	24-72x36	3,327	3,645	135	250	52
	CCS	G	24-78x36	3,538	3,879	178	260	56
	CCS	H	30-66x42	3,646	3,998	135	250	52
	CCS	I	30-72x42	3,646	3,998	135	260	56
	CCS	J	30-78x42	3,753	4,115	178	275	60
	CCS	K	36-72x48	3,863	4,235	135	275	60
	CCS	L	36-78x48	4,095	4,353	178	285	64

RIGHT OR LEFT
Specify (RP) for Right Pedestal or
(LP) for Left Pedestal

NOTE
Black grommet standard

TABLE OF CONTENTS

Configuration	Quick Model	Quick Size	Size	Fluted-V	Concord-V	Carton	B-Weight	Cube
Computer Desk Full Ped Full Modesty								
	CDF	A	20-60x30	3,175	3,480	135	190	36
	CDF	B	20-66x30	3,390	3,716	135	200	40
	CDF	C	20-72x30	3,390	3,716	135	225	50
	CDF	D	20-78x30	3,602	3,888	178	235	54
	CDF	E	24-66x36	3,496	3,834	135	245	46
	CDF	F	24-72x36	3,496	3,834	135	255	50
	CDF	G	24-78x36	3,711	4,069	178	265	54
	CDF	H	30-66x42	3,818	4,188	135	265	54
	CDF	I	30-72x42	3,818	4,188	135	275	60
	CDF	J	30-78x42	3,924	4,304	178	285	64
	CDF	K	36-72x48	4,034	4,424	135	300	68
	CDF	L	36-78x48	4,268	4,538	178	320	72

FLUTED-V

Edge also included in pricing:
Saga-V

CONCORD-V

Edge also included in pricing:
Victory-V

FAN TOP



Add \$728 list for 6" fan top (FT)

RADIAL CORNER



Add \$206 list for radial corner (RC)

Computer Desk Lateral File w/Black Pulls Full Modesty								
	DL	A	20-72x30	3,968	4,353	135	230	44
	DL	B	20-78x30	4,182	4,588	178	240	48
	DL	C	24-72x36	4,077	4,468	135	255	50
	DL	D	24-78x36	4,288	4,702	178	265	54
	DL	E	30-72x42	4,397	4,822	135	265	60
	DL	F	30-78x42	4,503	4,937	178	305	64
	DL	G	36-72x48	4,611	5,057	135	320	68
	DL	H	36-78x48	4,845	5,173	178	340	72

Computer Desk Personal Lateral File w/Black Pulls Full Modesty								
	CP	A	20-72x30	4,451	4,702	135	238	44
	CP	B	20-78x30	4,503	4,937	178	248	48
	CP	C	24-72x36	4,397	4,822	135	273	50
	CP	D	24-78x36	4,610	5,055	178	263	54
	CP	E	30-72x42	4,718	5,172	135	293	60
	CP	F	30-78x42	4,828	5,293	178	313	64
	CP	G	36-72x48	4,933	5,410	135	328	68
	CP	H	36-78x48	5,168	5,528	178	348	72

RIGHT OR LEFT

Specify (RP) for Right Pedestal or (LP) for Left Pedestal

NOTE

Black grommet standard

TABLE OF CONTENTS

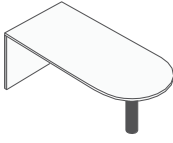
Configuration	Quick Model	Quick Size	Size	Fluted-V	Concord-V	Carton	B-Weight	Cube
Bullet Desk No Ped ¾ Modesty – add \$210 for Full (FM)								
	BN	A	30x60	2,703	2,964	135	130	36
	BN	B	30x66	2,917	3,199	135	154	42
	BN	C	30x72	2,917	3,199	135	145	43
	BN	D	36x72	3,026	3,316	135	165	50
	BN	E	36x78	3,237	3,552	178	200	64
	BN	F	42x84	3,451	3,786	178	220	68

FLUTED-V
Edge also included in pricing:
Saga-V

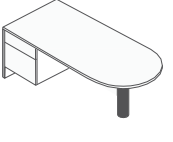
Bullet Desk ¾ Ped ¾ Modesty – add \$210 for Full (FM)								
	BS	A	30x60	3,237	3,552	135	235	42
	BS	B	30x66	3,451	3,786	135	235	42
	BS	C	30x72	3,451	3,786	135	245	50
	BS	D	36x72	3,559	3,902	178	265	54
	BS	E	36x78	3,777	4,141	178	275	64
	BS	F	42x84	3,989	4,376	178	285	68

CONCORD-V
Edge also included in pricing:
Victory-V

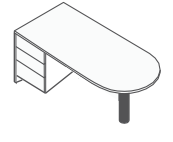
Bullet Desk Full Ped Full Modesty								
	BF	A	30x60	3,411	3,739	133	230	38
	BF	B	30x66	3,622	3,973	133	240	40
	BF	C	30x72	3,622	3,973	133	250	40
	BF	D	36x72	3,732	4,090	133	265	42
	BF	E	36x78	3,946	4,326	177	275	46
	BF	F	42x84	4,162	4,564	178	310	50

NOTE
BN model not intended for sale as freestanding desk. See bridges and returns.

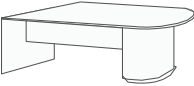
Bullet Desk ½ Cylinder Desk No Ped add \$210 for Full Modesty (FM)								
	BCN	A	30x60	3,346	3,667	135	255	42
	BCN	B	30x66	3,559	3,902	135	270	44
	BCN	C	30x72	3,559	3,902	135	270	44
	BCN	D	36x72	3,666	4,020	135	285	48
	BCN	E	36x78	3,883	4,256	178	310	60
	BCN	F	42x84	4,097	4,492	178	330	64

POST
Standard in black

Available in silver, add \$32 list

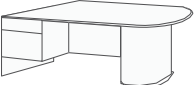
Bullet Desk ¾ Ped ¾ Modesty – add \$210 for Full (FM)								
	BCS	A	30x60	3,883	4,256	135	260	40
	BCS	B	30x66	4,097	4,492	135	280	42
	BCS	C	30x72	4,097	4,492	135	300	44
	BCS	D	36x72	4,203	4,609	135	320	44
	BCS	E	36x78	4,418	4,844	178	340	52
	BCS	F	42x84	4,633	5,081	178	350	64

RIGHT OR LEFT
Specify (RP) for Right Pedestal or (LP) for Left Pedestal

Bullet Desk Full Ped Full Modesty								
	BCF	A	30x60	4,054	4,444	135	270	42
	BCF	B	30x66	4,269	4,679	135	270	44
	BCF	C	30x72	4,269	4,679	135	310	46
	BCF	D	36x72	4,373	4,799	135	320	48
	BCF	E	36x78	4,589	5,032	178	340	54
	BCF	F	42x84	4,804	5,267	178	360	64

TABLE OF CONTENTS

Configuration	Quick Model	Quick Size	Size	Fluted-V	Concord-V	Carton	B-Weight	Cube
L-Shaped Desk ¾ Ped ¾ Modesty – add \$420 for Full (FM)								
	D	1	30x66 Desk 24x42 Return	5,086	5,574	252	300	64
	D	2	36x72 Desk 24x48 Return	5,300	5,810	252	355	75
L-Shaped Desk Full Ped Full Modesty								
	D	3	36x72 Desk 24x48 Return	5,135	6,186	252	410	75
L-Shaped Computer Desk ¾ Ped ¾ Modesty – add \$420 for Full (FM)								
	D	4	36-72x48 Desk 24x48 Return	6,157	6,753	306	340	75
L-Shaped Computer Desk Full Ped Full Modesty								
	D	5	36-72x48 Desk 24x48 Return	6,499	7,129	306	367	75

FLUTED-V

Edge also included in pricing:
Saga-V

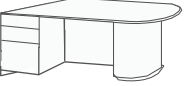
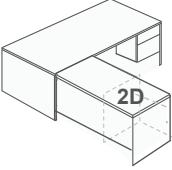
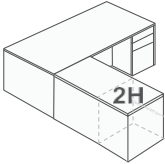
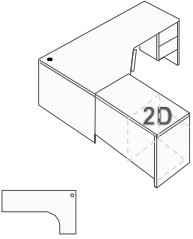
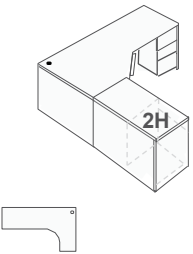
CONCORD-V

Edge also included in pricing:
Victory-V

FAN TOP



Add \$728 list for 6" fan top (FT)

RADIAL CORNER



Add \$206 list for radial corner (RC)

RIGHT OR LEFT

Specify (R) for Right Return or (L) for Left Return

NOTE

Black grommet are standard on Computer Desk

TABLE OF CONTENTS

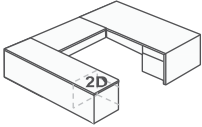
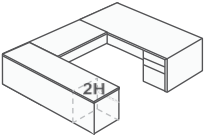
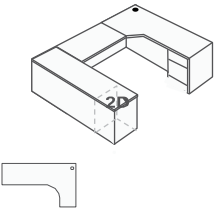
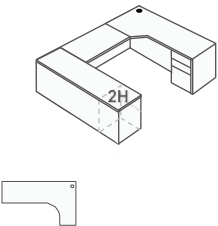
Configuration	Quick Model	Quick Size	Size	Fluted-V	Concord-V	Carton	B-Weight	Cube
U-Shaped Desk ¾ Ped ¾ Modesty – add \$420 for Full (FM)								
	D	6	36X72 Desk 24x48 Bridge 24x72 Credenza	7,399	8,113	346	455	98
U-Shaped Desk Full Ped Full Modesty								
	D	7	36X72 Desk 24x48 Bridge 24x72 Credenza	7,956	8,725	346	580	115
U-Shaped Computer Desk ¾ Ped ¾ Modesty – add \$420 for Full (FM)								
	D	8	30-72x42 Desk 24x48 Bridge 24x72 Credenza	7,934	8,699	346	455	98
U-Shaped Computer Desk Full Ped Full Modesty								
	D	9	30-72x42 Desk 24x48 Bridge 24x72 Credenza	8,464	9,196	346	580	115

FLUTED-V

Edge also included in pricing:
Saga-V

CONCORD-V

Edge also included in pricing:
Victory-V

FAN TOP



Add \$728 list for 6" fan top (FT)

RADIAL CORNER



Add \$206 list for radial corner (RC)

RIGHT OR LEFT

Specify (R) for Right Bridge or (L) for Left Bridge

NOTE

Black grommet are standard on Computer Desk

TABLE OF CONTENTS

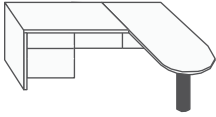
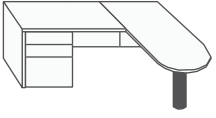
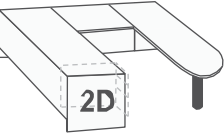
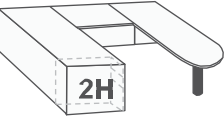
Configuration	Quick Model	Quick Size	Size	Fluted-V	Concord-V	Carton	B-Weight	Cube
L-Shaped Bullet Desk ¾ Ped ¾ Modesty – add \$420 for Full (FM)								
	D	10	36X72 Desk 24x48 Return	5,425	5,950	224	290	68
L-Shaped Bullet Desk Full Ped Full Modesty								
	D	11	36X72 Desk 24x48 Return	5,596	6,138	224	315	72
U-Shaped Bullet Desk ¾ Ped ¾ Modesty – add \$420 for Full (FM)								
	D	12	36x72 Desk 24x48 Bridge 24x72 Credenza	7,529	8,254	330	555	96
U-Shaped Bullet Desk Full Ped Full Modesty								
	D	13	36x72 Desk 24x48 Bridge 24x72 Credenza	7,699	8,442	330	583	96

FLUTED-V

Edge also included in pricing:
Saga-V

CONCORD-V

Edge also included in pricing:
Victory-V

POST

Standard in black

Available in silver, add \$32 list

RIGHT OR LEFT

Specify (R) for Right Bridge or (L)
for Left Bridge

TABLE OF CONTENTS

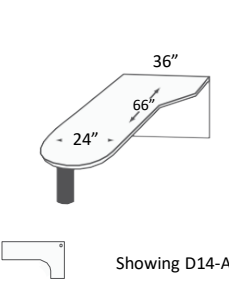
Configuration	Quick Model	Quick Size	Size	Fluted-V	Concord-V	Carton	B-Weight	Cube
Bullet Computer Desk Shell ¾ Modesty – add \$210 for Full (FM)								
 <p>Showing D14-A</p>	D14	A	24-66X36	2,917	3,199	135	125	42
	D14	B	24-72X36	3,026	3,316	135	135	45
	D14	C	24-78X36	3,131	3,434	178	145	48
	D14	D	30-66X42	3,237	3,552	135	145	51
	D14	E	30-72X42	3,346	3,667	135	155	54
	D14	F	30-78X42	3,451	3,786	178	165	57
	D14	G	36-66X48	3,559	3,902	135	165	60
	D14	H	36-72X48	3,666	4,020	135	175	63
	D14	I	36-78X48	3,777	4,141	178	185	66

FLUTED-V
Edge also included in pricing:
Saga-V

CONCORD-V
Edge also included in pricing:
Victory-V

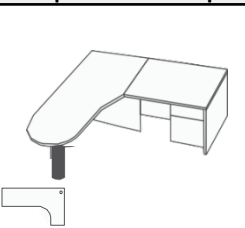
L-Shaped Bullet Computer Desk ¾ Ped ¾ Modesty – add \$420 for Full (FM)								
	D	15	30-72x42 Desk 24x48 Return	5,746	6,302	224	255	78

NOTE
D14 model not intended for sale
as freestanding desk. See for
bridges and returns.

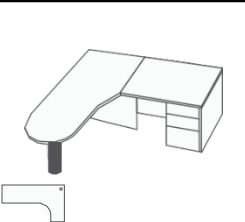
L-Shaped Bullet Computer Desk Full Ped Full Modesty								
	D	16	30-72x42 Desk 24x48 Return	5,921	6,492	224	285	78

RADIAL CORNER

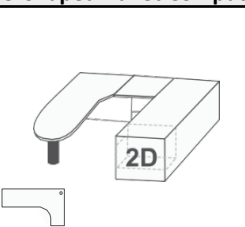

Add \$206 list for radial corner (RC)

U-Shaped Bullet Computer Desk ¾ Ped ¾ Modesty – add \$420 for Full (FM)								
	D	17	30-72x42 Desk 24x42 Bridge 24x72 Credenza	7,740	8,488	369	465	106

POST

Standard in black

Available in silver, add \$32 list

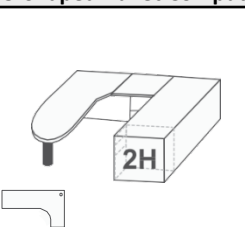
U-Shaped Bullet Computer Desk Full Ped Full Modesty								
	D	18	30-72x42 Desk 24x42 Bridge 24x72 Credenza	7,914	8,678	369	495	106

RIGHT OR LEFT

Specify (R) for Right Bridge or (L)
for Left Bridge

TABLE OF CONTENTS

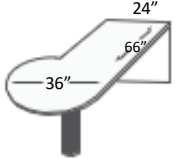
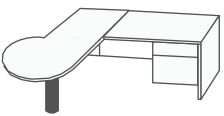
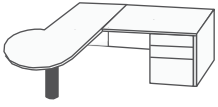
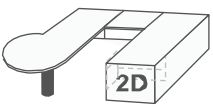
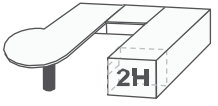
Configuration	Quick Model	Quick Size	Size	Fluted-V	Concord-V	Carton	B-Weight	Cube
P-Shaped Desk Shell ¾ Modesty – add \$210 for Full (FM)								
 <p>Showing D19-A</p>	D19	A	36-66x24	3,186	3,490	135	105	42
	D19	B	36-72x24	3,291	3,612	144	120	45
	D19	C	36-78x24	3,399	3,729	159	135	49
	D19	D	42-66x30	3,507	3,847	144	150	48
	D19	E	42-72x30	3,614	3,963	159	165	53
	D19	F	42-78x30	3,700	4,058	167	180	57
	D19	G	48-66x36	3,827	4,196	159	195	55
	D19	H	48-72x36	3,937	4,316	167	210	60
	D19	I	48-78x36	4,042	4,432	178	225	66
L-Shaped P-Desk ¾ Ped ¾ Modesty – add \$420 for Full (FM)								
	D	20	48-78x36 Desk 24x48 Return	6,447	7,068	269	285	86
L-Shaped P-Desk Full Ped Full Modesty								
	D	21	48-78x36 Desk 24x48 Return	6,617	7,257	269	298	86
U-Shaped P-Desk ¾ Ped ¾ Modesty – add \$420 for Full (FM)								
	D	22	48-78x36 Desk 24x48 Bridge 24x78 Credenza	8,762	9,609	403	508	119
U-Shaped P-Desk Full Ped Full Modesty								
	D	23	48-78x36 Desk 24x48 Bridge 24x78 Credenza	8,932	9,797	403	538	119

FLUTED-V

Edge also included in pricing:
Saga-V

CONCORD-V

Edge also included in pricing:
Victory-V

NOTE

D19 model not intended for sale as freestanding desk. See bridges and returns.

POST

Standard in black

Available in silver, add \$32 list

RIGHT OR LEFT

Specify (R) for Right Bridge or (L) for Left Bridge

TABLE OF CONTENTS

Configuration	Quick Model	Quick Size	Size	Fluted-V	Concord-V	Carton	B-Weight	Cube
P-Shaped Computer Desk Shell ¾ Modesty – add \$210 for Full (FM)								
<p>Showing D24-A</p>	D24	A	36-66x36	4,473	4,905	135	80	80
	D24	B	36-72x36	4,581	5,021	135	106	106
	D24	C	36-78x36	4,793	5,257	178	106	106
	D24	D	42-66x42	4,787	5,250	178	106	106
	D24	E	42-72x42	4,900	5,374	178	106	106
	D24	F	42-78x42	5,114	5,607	224	106	106

FLUTED-V
Edge also included in pricing:
Saga-V

CONCORD-V
Edge also included in pricing:
Victory-V

NOTE
D24 model not intended for sale as freestanding desk. See bridges and returns.

P-Shaped Computer Desk ¾ Ped ¾ Modesty – add \$420 for Full (FM)								
	D	25	36-78x36 Desk 24x48 Return	7,194	7,891	269	285	86

P-Shaped Computer Desk Full Ped Full Modesty								
	D	26	36-78x36 Desk 24x48 Return	7,461	8,206	269	298	86

RADIAL CORNER



Add \$206 list for radial corner (RC)

U-Shaped P-Desk ¾ Ped ¾ Modesty – add \$420 for Full (FM)								
	D	27	36-78x36 Desk 24x48 Bridge 24x78 Credenza	9,512	10,430	403	508	119

POST
Standard in black

Available in silver, add \$30 list

U-Shaped P-Desk Full Ped Full Modesty								
	D	28	36-78x36 Desk 24x48 Bridge 24x78 Credenza	9,683	10,619	403	538	119

RIGHT OR LEFT
Specify (R) for Right Bridge or (L) for Left Bridge

TABLE OF CONTENTS

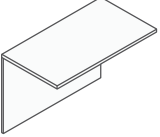
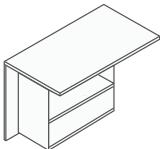
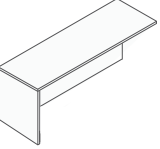
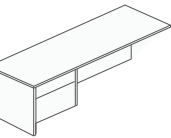
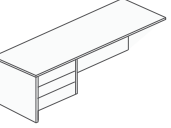
Configuration	Quick Model	Quick Size	Size	Fluted-V	Concord-V	Carton	B-Weight	Cube
Bridge ¾ Mod w/2D Desk or Credenza Full Mod w/3H Desk or Credenza								
	B	A	20x36	1,406	1,572	102	55	15
	B	B	20x42	1,509	1,685	102	60	17
	B	C	20x48	1,614	1,804	102	65	19
	B	D	20x54	1,718	1,918	102	70	21
	B	E	24x36	1,448	1,619	102	60	18
	B	F	24x42	1,552	1,733	102	65	21
	B	G	24x48	1,657	1,850	102	70	24
	B	H	24x54	1,760	1,964	102	75	27
Bridge 12" Deep Bookcase								
	1BB	A	20x36	2,029	2,267	102	90	15
	1BB	B	20x42	2,130	2,378	102	95	17
	1BB	C	20x48	2,234	2,497	102	100	19
	1BB	D	20x54	2,337	2,611	102	105	21
	1BB	E	24x36	2,070	2,311	102	100	18
	1BB	F	24x42	2,172	2,427	102	105	21
	1BB	G	24x48	2,276	2,542	102	115	24
	1BB	H	24x54	2,381	2,659	102	125	27
Return Shell ¾ modesty – add \$210 for Full (FM)								
	R	A	20x36	1,554	1,733	102	55	15
	R	B	20x42	1,655	1,850	102	60	17
	R	C	20x48	1,760	1,964	102	65	19
	R	D	20x54	1,860	2,081	102	70	21
	R	E	24x36	1,595	1,781	102	75	18
	R	F	24x42	1,698	1,894	102	85	21
	R	G	24x48	1,801	2,012	102	60	24
	R	H	24x54	1,904	2,128	102	65	27
Return ¾ Ped (Box/File) ¾ modesty – add \$210 for Full (FM)								
	R2	A	20x36	2,070	2,311	102	75	15
	R2	B	20x42	2,172	2,427	102	80	17
	R2	C	20x48	2,276	2,542	102	85	19
	R2	D	20x54	2,381	2,659	102	90	21
	R2	E	24x36	2,110	2,358	102	80	18
	R2	F	24x42	2,213	2,472	102	85	21
	R2	G	24x48	2,316	2,587	102	100	24
	R2	H	24x54	2,421	2,704	102	115	27
Return ¾ Ped (Box/Box/Box) ¾ modesty – add \$210 for Full (FM)								
	R3	A	20x36	2,003	2,235	102	75	15
	R3	B	20x42	2,098	2,339	102	80	17
	R3	C	20x48	2,198	2,456	102	85	19
	R3	D	20x54	2,296	2,564	102	90	21
	R3	E	24x36	2,041	2,281	102	80	17
	R3	F	24x42	2,134	2,382	102	85	19
	R3	G	24x48	2,230	2,485	102	100	24
	R3	H	24x54	2,537	2,828	102	115	27

FLUTED-V
Edge also included in pricing:
Saga-V

CONCORD-V
Edge also included in pricing:
Victory-V

RIGHT OR LEFT
Specify (R) for Right or (L) for
Left

TABLE OF CONTENTS

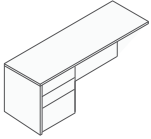
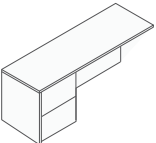
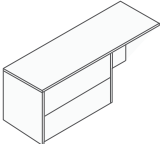
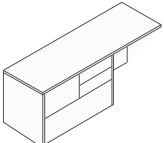
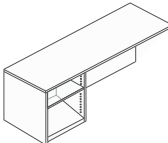
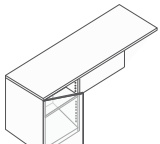
Configuration	Quick Model	Quick Size	Size	Fluted-V	Concord-V	Carton	B-Weight	Cube
Return Full Ped (Box/Box/File) Full Modesty								
	RF	A	20x36	2,297	2,563	102	105	15
	RF	B	20x42	2,400	2,676	102	115	17
	RF	C	20x48	2,503	2,793	102	125	19
	RF	D	20x54	2,607	2,909	102	135	21
	RF	E	24x36	2,339	2,607	102	140	18
	RF	F	24x42	2,442	2,724	102	150	24
	RF	G	24x48	2,546	2,824	102	155	24
	RF	H	24x54	2,649	2,956	102	160	27
Return Full Ped (File/File) Full Modesty								
	RL	A	20x36	2,297	2,563	102	105	15
	RL	B	20x42	2,400	2,676	102	115	17
	RL	C	20x48	2,503	2,793	102	125	19
	RL	D	20x54	2,607	2,909	102	135	21
	RL	E	24x36	2,339	2,607	102	140	18
	RL	F	24x42	2,442	2,724	102	150	21
	RL	G	24x48	2,546	2,824	102	155	24
	RL	H	24x54	2,649	2,956	102	160	27
Return Lateral File w/Standard Black Pulls Full Modesty								
	RLF	A	20x48	3,054	3,410	102	175	19
	RLF	B	20x54	3,159	3,527	102	180	21
	RLF	C	20x60	3,264	3,645	102	185	24
	RLF	D	24x48	3,094	3,456	102	180	24
	RLF	E	24x54	3,198	3,575	102	185	27
	RLF	F	24x60	3,306	3,692	102	190	29
Return Personal Lateral File w/Standard Black Pulls Full Modesty								
	PF	A	20x48	3,370	3,697	102	184	19
	PF	B	20x54	3,475	3,812	102	189	21
	PF	C	20x60	3,581	3,928	102	194	24
	PF	D	24x48	3,414	3,743	102	184	24
	PF	E	24x54	3,518	3,857	102	189	27
	PF	F	24x60	3,624	3,973	102	194	30
Return Personal Printer w/Adjustable Shelf Full Modesty								
	PP	A	20x48	2,485	2,726	102	92	19
	PP	B	20x54	2,593	2,842	102	102	21
	PP	C	20x60	2,698	2,958	102	112	24
	PP	D	24x48	2,529	2,771	102	122	24
	PP	E	24x54	2,634	2,889	102	132	27
	PP	F	24x60	2,844	3,122	102	142	30
Return Personal Printer w/Door Full Modesty								
	PPD	A	20x48	2,747	3,000	102	92	19
	PPD	B	20x54	2,854	3,117	102	102	21
	PPD	C	20x60	2,962	3,232	102	112	24
	PPD	D	24x48	2,791	3,047	102	122	24
	PPD	E	24x54	2,897	3,164	102	132	27
	PPD	F	24x60	3,106	3,396	102	142	30

FLUTED-V
Edge also included in pricing:
Saga-V

CONCORD-V
Edge also included in pricing:
Victory-V

RIGHT OR LEFT
Specify (R) for Right Return or
(L) for Left Return

TABLE OF CONTENTS

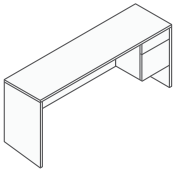
Configuration	Quick Model	Quick Size	Size	Fluted-V	Concord-V	Carton	B-Weight	Cube
Kneespace Credenza ¼ Ped ¾ modesty – add \$210 for Full (FM)								
	C3	A	20x60	2,423	2,659	135	175	22
	C3	B	20x66	2,530	2,772	135	180	26
	C3	C	20x72	2,635	2,890	135	185	28
	C3	D	20x78	2,845	3,123	178	190	30
	C3	E	24x60	2,530	2,772	135	180	26
	C3	F	24x66	2,635	2,890	135	185	28
	C3	G	24x72	2,741	3,005	135	190	30
	C3	H	24x78	2,953	3,236	178	200	32

FLUTED-V
Edge also included in pricing:
Saga-V

CONCORD-V
Edge also included in pricing:
Victory-V

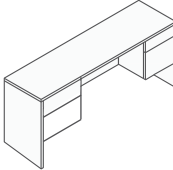
Kneespace Credenza Double ¼ Ped ¾ modesty – add \$210 for Full (FM)								
	CK	A	20x60	3,004	3,293	135	195	24
	CK	B	20x66	3,111	3,410	135	205	26
	CK	C	20x72	3,216	3,527	135	215	28
	CK	D	20x78	3,325	3,645	178	225	30
	CK	E	24x60	3,111	3,410	135	205	26
	CK	F	24x66	3,216	3,527	135	215	28
	CK	G	24x72	3,325	3,645	135	225	30
	CK	H	24x78	3,431	3,763	178	235	32

RIGHT OR LEFT
Specify (R) for Right Ped or Left
(L) or Left Ped on credenza
w/single ped

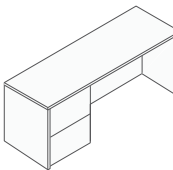
Kneespace Credenza Full Ped (File/File) Full Modesty								
	CSP	A	20x60	2,594	2,843	135	182	22
	CSP	B	20x66	2,700	2,959	135	192	26
	CSP	C	20x72	2,805	3,076	135	202	28
	CSP	D	20x78	3,014	3,307	178	212	30
	CSP	E	24x60	2,700	2,959	135	187	26
	CSP	F	24x66	2,805	3,076	135	192	28
	CSP	G	24x72	3,014	3,307	135	222	30
	CSP	H	24x78	3,120	3,420	178	232	32

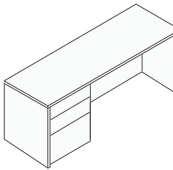
Kneespace Credenza Full Ped (Box/Box/File) Full Modesty								
	CS3	A	20x60	2,594	2,843	135	182	22
	CS3	B	20x66	2,700	2,959	135	192	26
	CS3	C	20x72	2,805	3,076	135	202	28
	CS3	D	20x78	3,014	3,307	178	212	30
	CS3	E	24x60	2,700	2,959	135	187	26
	CS3	F	24x66	2,805	3,076	135	192	28
	CS3	G	24x72	3,014	3,307	135	222	30
	CS3	H	24x78	3,120	3,420	178	232	32

Kneespace Credenza Double Full Ped Full Modesty								
	CN	A	20x60	3,451	3,786	135	185	24
	CN	B	20x66	3,559	3,902	135	190	26
	CN	C	20x72	3,666	4,020	135	198	28
	CN	D	20x78	3,777	4,141	178	210	30
	CN	E	24x60	3,559	3,902	135	190	26
	CN	F	24x66	3,666	4,020	135	198	28
	CN	G	24x72	3,777	4,141	135	210	30
	CN	H	24x78	3,883	4,256	178	220	32

TABLE OF CONTENTS

Configuration	Quick Model	Quick Size	Size	Fluted-V	Concord-V	Carton	B-Weight	Cube
Credenza ¾ Storage w/Hinged Doors ¾ modesty – add \$210 for Full (FM)								
	CS	A	20x60	3,111	3,410	135	175	22
	CS	B	20x66	3,325	3,645	135	180	26
	CS	C	20x72	3,431	3,763	135	185	28
	CS	D	20x78	3,538	3,879	178	190	30
	CS	E	24x60	3,216	3,527	135	180	26?
	CS	F	24x66	3,431	3,763	135	185	28
	CS	G	24x72	3,538	3,879	135	190	30
	CS	H	24x78	3,644	3,998	178	200	32

FLUTED-V
Edge also included in pricing:
Saga-V

CONCORD-V
Edge also included in pricing:
Victory-V

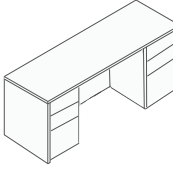
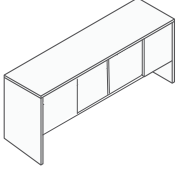
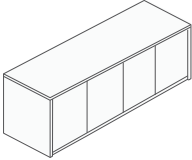
Credenza Full Storage w/Hinged Doors Full Modesty								
	CT	A	20x60	3,753	4,115	135	185	24
	CT	B	20x66	3,861	4,235	135	190	26
	CT	C	20x72	3,968	4,353	135	195	28
	CT	D	20x78	4,077	4,468	178	200	30
	CT	E	24x60	3,861	4,235	135	190	26
	CT	F	24x66	3,968	4,353	135	195	28
	CT	G	24x72	4,077	4,468	135	200	30
	CT	H	24x78	4,182	4,588	178	205	32

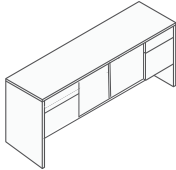
Credenza ¾ Ped w/Hinged Doors ¾ modesty – add \$210 for Full (FM)								
	CA	A	20x60	3,216	3,527	132	220	24
	CA	B	20x66	3,325	3,645	132	225	26
	CA	C	20x72	3,431	3,763	132	230	28
	CA	D	20x78	3,538	3,879	176	240	30
	CA	E	24x60	3,325	3,645	132	225	24
	CA	F	24x66	3,431	3,763	132	230	28
	CA	G	24x72	3,538	3,879	132	235	30
	CA	H	24x78	3,644	3,998	176	245	32

Credenza Full Ped w/Hinged Doors Full Modesty								
	CF	A	20x60	4,097	4,492	135	250	24
	CF	B	20x66	4,203	4,609	135	258	26
	CF	C	20x72	4,309	4,728	135	268	28
	CF	D	20x78	4,418	4,844	178	280	30
	CF	E	24x60	4,203	4,609	135	258	26
	CF	F	24x66	4,309	4,728	135	268	28
	CF	G	24x72	4,418	4,844	135	280	30
	CF	H	24x78	4,525	4,961	178	292	32

TABLE OF CONTENTS

Configuration	Quick Model	Quick Size	Size	Fluted-V	Concord-V	Carton	B-Weight	Cube
Kneespace Credenza Personal Lateral								
	CPK	A	20x72	3,757	4,119	135	228	28
	CPK	B	20x78	3,865	4,237	178	238	30
	CPK	C	24x72	3,972	4,357	135	248	30
	CPK	D	24x78	4,081	4,472	178	258	32

FLUTED-V
Edge also included in pricing:
Saga-V

Kneespace Credenza Lateral File								
	CL	A	20x72	3,433	3,766	135	220	28
	CL	B	20x78	3,540	3,881	178	230	30
	CL	C	24x72	3,647	4,001	135	240	30
	CL	D	24x78	3,756	4,118	178	250	32

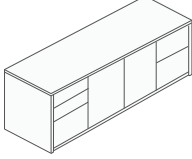
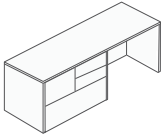
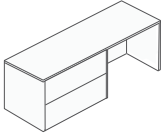
CONCORD-V
Edge also included in pricing:
Victory-V

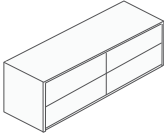
Credenza Double Lateral								
	CDL	A	20x72	4,066	4,457	135	340	28
	CDL	B	24x72	4,277	4,689	135	360	30

RIGHT OR LEFT
Specify (R) for Right Ped or Left (L) or Left Ped on credenza w/single ped

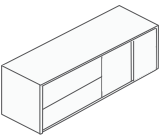
Credenza Lateral/Storage								
	CLS	A	20x72	4,066	4,457	135	306	28
	CLS	B	24x72	4,277	4,689	135	326	30

Credenza Personal Lateral/Storage								
	CPL	A	20x72	4,385	4,809	135	316	28
	CPL	B	24x72	4,596	5,041	135	336	30

TABLE OF CONTENTS

Configuration	Quick Model	Quick Size	Size	Fluted-V	Concord-V	Carton	B-Weight	Cube
Buffet Credenza Full Hinged Doors								
	HDHD	A	20x72x36	4,515	4,919	182	230	30
	HDHD	B	24x72x36	4,606	5,035	182	250	36
	HDHD	C	20x78x36	4,788	5,224	218	270	33
	HDHD	D	24x78x36	4,969	5,415	218	290	39

FLUTED-V
Edge also included in pricing:
Saga-V

Buffet Credenza Hinged Doors & Drawers								
	BBHD	A	20x72x36	5,317	5,759	182	310	30
	BBHD	B	24x72x36	5,405	5,872	182	330	36
	BBHD	C	20x78x36	5,587	6,062	218	350	33
	BBHD	D	24x78x36	5,768	6,251	218	370	39

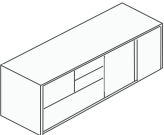
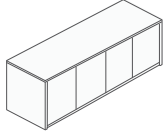
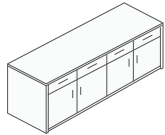
CONCORD-V
Edge also included in pricing:
Victory-V

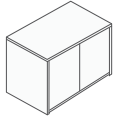
Credenza Hinged Door Storage								
	HD	A	20x36	2,435	2,667	102	180	13
	HD	B	24x36	2,541	2,782	102	190	15
	HD	C	20x36x36	2,668	2,908	126	201	15
	HD	D	24x36x36	2,780	3,024	126	211	18

NOTE
Black pulls are standard where shown





Buffet Credenza Hinged Door Storage w/Drawers								
	BHD	A	20x36x36	3,029	3,287	113	220	15
	BHD	B	24x36x36	3,137	3,394	113	230	18

TABLE OF CONTENTS

Configuration	Quick Model	Quick Size	Size	Fluted-V	Concord-V	Carton	B-Weight	Cube
Lateral File 2 Drawer								
	LF	A	20x36	2,423	2,655	102	178	15
	LF	B	24x36	2,530	2,775	102	192	17
Lateral File 3 Drawer								
	LF3	A	20x36x42	3,635	3,984	163	240	17
	LF3	B	24x36x42	3,796	4,162	163	260	20
Lateral File 4 Drawer								
	LF4	A	20x36x54	4,845	5,312	218	300	22
	LF4	B	24x36x54	5,060	5,548	218	320	26
Personal Lateral File								
	PLF	A	20x36	2,747	3,011	102	188	15
	PLF	B	24x36	2,854	3,129	102	202	17
Vertical File 2 Drawer								
	VF	A	24x18	2,103	2,306	102	140	8
	VF	B	24x21	2,208	2,422	102	150	9
Vertical File 3 Drawer								
	VF3	A	24x18x42	3,153	3,457	163	200	11
	VF3	B	24x21x42	3,312	3,634	163	220	13
Vertical File 4 Drawer								
	VF4	A	24x18x54	4,205	4,611	218	260	15
	VF4	B	24x21x54	4,417	4,844	218	280	17

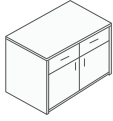
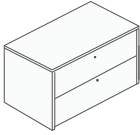
FLUTED-V
Edge also included in pricing:
Saga-V

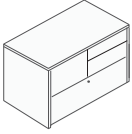
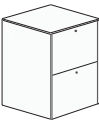
CONCORD-V
Edge also included in pricing:
Victory-V

NOTE
High profile furniture should be anchored to the wall by licensed installers using own fasteners

One face lock for each drawer included on file drawers

OPTIONAL GANGLOCK

For 2 Drawer: Add \$109 list

For 3 Drawer: Add \$194 list



For 4 Drawer: Add \$279 list

VERTICAL FILE

A = Letter Size

B = Legal Size

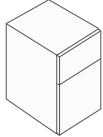
TABLE OF CONTENTS

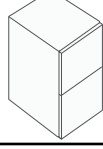
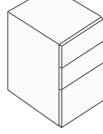
Configuration	Quick Model	Quick Size	Size	Price	Carton	B-Weight	Cube
Free-stand Pedestal Box/File							
	2D	PD	23X16X19.5	748	84	84	6
	2D	PCR	19X16X19.5	748	84	84	6
Free-stand Pedestal Box/Box/Box							
	3D	PD	23X16X19.5	855	97	90	6
	3D	PCR	19X16X19.5	855	97	90	6
Free-stand Pedestal Four Box Drawer							
	4D	PD	23X16X25.5	1,070	97	109	8
	4D	PCR	19X16X25.5	1,070	97	109	8
Free-stand Pedestal File/File							
	2H	PD	23X16X25.5	964	97	99	8
	2H	PCR	19X16X25.5	964	97	99	8
Free-stand Pedestal Box/Box/File							
	3H	PD	23X16X25.5	964	97	99	8
	3H	PCR	19X16X25.5	964	97	99	8

NOTE

Finished peds come with 3/4" top and square edges

All drawers come with ball-bearing suspensions



CASTERS or KICK BASE
Add \$61 list for casters or kick base

Pedestal becomes 2" higher

GANGLOCK or PED-LOCK

Add \$109 list

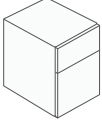
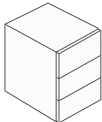
TABLE OF CONTENTS

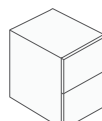
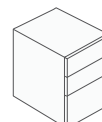
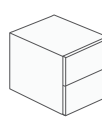
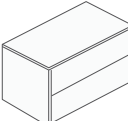
Configuration	Quick Model	Quick Size	Size	Price	Carton	B-Weight	Cube
Hanging Pedestal Box/File							
	2D		23x16x18	645	84	75	4
Hanging Pedestal Box/Box/Box							
	3D		23x16x18	645	84	75	4
Hanging Pedestal Four Box Drawer							
	4D		23x16x24	857	97	100	6
Hanging Pedestal File/File							
	2H		23x16x24	751	97	90	6
Hanging Pedestal Box/Box/File							
	3H		23x16x24	751	97	90	6
Hanging Pedestal – Legal Size File/File							
	2LS		23x20x24	967	97	100	6
Hanging Pedestal Lateral File							
	LF		23x36x24	1,393	87	120	10

NOTE

Hanging pedestals are designed to customize your desk shell, desk, credenza, etc.

All peds are one side finished, unfinished top and back, and field installable

TABLE OF CONTENTS

WARDROBE

Configuration is applicable for 20x36x72 or higher

Use pricing from Full Hinged (BCW-F-3) and up

Smaller size DON'T have Bottom Shelf

For 24" Depth Laminate, add \$166 list
For 24" Veneer, add \$331 list

For Double Face Lock "Installed on top doors", add \$66 list

For Lock Mechanism "Centered Installed", add \$281 list

Black pulls standard where shown

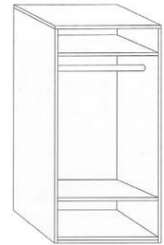

Centered (WD)
Add \$83 list

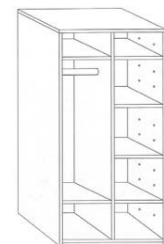

Left (WDL)
Add \$166 list

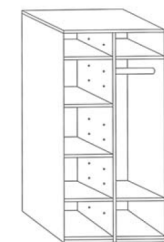

Right (WDR)
Add \$166 list

Configuration	Quick Model	Quick Size	Adj. Selves	Size	Fluted-V	Concord-V	Carton	B-Weight	Cube
Bookcase									
	BC	A	1	12x36x29	1,549	1,362	115	72	11
	BC	B	1	12x36x36	1,751	1,575	115	90	14
	BC	C	2	12x36x42	1,955	1,784	115	100	16
	BC	D	2	12x36x48	2,162	1,997	115	110	18
	BC	E	3	12x36x60	2,365	2,207	115	140	22
	BC	F	3	12x36x66	2,571	2,418	115	150	24
	BC	G	4	12x36x72	2,776	2,629	115	170	26
	BC	H	4	12x36x78	2,982	2,841	115	182	28
	BC	I	5	12x36x84	3,186	3,049	115	200	30

Bookcase Hinged Doors									
	BCH	A	1	14x36x60	3,029	2,887	218	140	22
	BCH	B	1	14x36x66	3,234	3,096	218	155	24
	BCH	C	2	14x36x72	3,437	3,311	218	170	28
	BCH	D	2	14x36x78	3,647	3,521	218	185	30
	BCH	E	3	14x36x84	3,849	3,733	218	200	32
	BCH	F	1	20x36x60	3,638	3,515	218	177	25
	BCH	G	1	20x36x66	4,036	3,922	218	188	28
	BCH	H	2	20x36x72	4,302	4,198	218	203	30
	BCH	I	2	20x36x78	4,554	4,457	218	218	33
	BCH	J	3	20x36x84	4,806	4,715	218	233	35

Bookcase Full Hinged									
	BCW	A	3	14x36x60	3,690	3,565	218	185	22
	BCW	B	3	14x36x66	3,895	3,781	218	195	24
	BCW	C	4	14x36x72	4,102	3,989	218	220	26
	BCW	D	4	14x36x78	4,306	4,202	218	235	28
	BCW	E	5	14x36x84	4,505	4,406	218	255	30
	BCW	F	3	20x36x60	4,302	4,198	218	218	25
	BCW	G	3	20x36x66	4,699	4,604	218	228	28
	BCW	H	4	20x36x72	4,964	4,876	218	253	30
	BCW	I	4	20x36x78	5,217	5,138	218	268	33
	BCW	J	5	20x36x84	5,468	5,400	218	288	35

Bookcase Lateral File									
	BCL	A	1	20x36x60	4,351	4,247	218	275	28
	BCL	B	1	20x36x66	4,556	4,461	218	300	30
	BCL	C	2	20x36x72	4,760	4,670	218	330	32
	BCL	D	2	20x36x78	4,967	4,884	218	350	34
	BCL	E	3	20x36x84	5,171	5,092	218	370	38

Bookcase Hinged Doors/Lateral File									
	BC5	A	1	20x36x60	5,015	4,931	218	275	28
	BC5	B	1	20x36x66	5,218	5,140	218	300	30
	BC5	C	2	20x36x72	5,422	5,351	218	330	32
	BC5	D	2	20x36x78	5,626	5,561	218	350	34
	BC5	E	3	20x36x84	5,835	5,773	218	370	38

TABLE OF CONTENTS

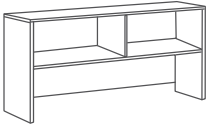
Configuration	Quick Model	Quick Size	Size	Fluted-V	Concord-V	Carton	B-Weight	Cube
Hutch Open								
	H0	A	14x33x37	1,258	1,380	76	110	15
	H0	B	14x45x37	1,419	1,556	86	120	18
	H0	C	14x57x37	1,717	1,885	101	130	22
	H0	D	14x63x37	1,868	2,048	112	135	25
	H0	E	14x69x37	2,013	2,207	120	145	28
	H0	F	14x75x37	2,168	2,378	132	160	31

FLUTED-V
Edge also included in pricing:
Saga-V

CONCORD-V
Edge also included in pricing:
Victory-V

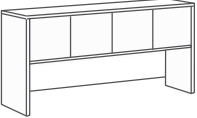
Hutch Hinged Doors								
	H1	A	14x33x37	1,714	1,879	76	120	15
	H1	B	14x45x37	1,933	2,120	86	130	18
	H1	C	14x57x37	2,427	2,660	101	140	22
	H1	D	14x63x37	2,673	2,931	112	145	25
	H1	E	14x69x37	2,920	3,203	120	155	28
	H1	F	14x75x37	3,166	3,472	132	170	31

NOTE
High profile furniture should be anchored to the credenza or desk top with provided dowels or metal brackets

Hutches have 20" clearance from the fixed shelf to the work surface, and a 2" gap for wire management

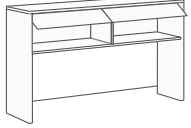
Hutch Garage Doors								
	H2	A	15x33x37	1,823	1,997	76	120	15
	H2	B	15x45x37	2,110	2,315	86	130	18
	H2	C	15x57x37	2,605	2,856	101	140	22
	H2	D	15x63x37	2,857	3,131	112	145	25
	H2	E	15x69x37	3,099	3,400	120	155	28
	H2	F	15x75x37	3,345	3,668	132	170	31

TASK LIGHTS
23" Silver Metal: \$255 list

Hutch Open w/Adjustable Shelves								
	H3	A	14x33x42	1,458	1,601	76	115	16
	H3	B	14x45x42	1,537	1,686	86	125	19
	H3	C	14x57x42	1,868	2,048	101	135	23
	H3	D	14x63x42	2,033	2,230	112	150	27
	H3	E	14x69x42	2,201	2,411	120	165	31
	H3	F	14x75x42	2,367	2,597	132	140	34

GLASS DOORS
Frosted Glass Doors (set of 2):
\$331 list

Not available for H2 and H5 hutches

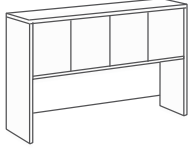
Hutch Hinged Doors w/Adjustable Shelves								
	H4	A	14x33x42	1,820	1,995	76	125	16
	H4	B	14x45x42	2,144	2,352	86	135	19
	H4	C	14x57x42	2,639	2,892	101	145	23
	H4	D	14x63x42	2,885	3,164	112	150	27
	H4	E	14x69x42	3,134	3,437	120	160	31
	H4	F	14x75x42	3,376	3,704	132	175	34

MAIL SORTER
Add \$364 list for mail sorter
Will reduce clearance from work surface by 5"

HINGED DOOR
H1A, H1B, H4A, and H4B come with 2 hinged doors; all others come with 4 hinged doors

TACKBOARDS

See page #26 for tackboards

GARAGE DOOR

H2A, H2B, H5A, and H5B come with 1 garage door; all others come with 2 garage doors

TABLE OF CONTENTS

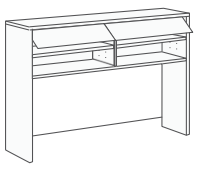
Configuration	Quick Model	Quick Size	Size	Fluted-V	Concord-V	Carton	B-Weight	Cube
Hutch Garage Doors w/Adjustable Shelves								
	H5	A	15x33x42	1,934	2,122	76	125	16
	H5	B	15x45x42	2,322	2,546	86	135	19
	H5	C	15x57x42	2,816	3,087	101	145	23
	H5	D	15x63x42	3,061	3,358	112	150	27
	H5	E	15x69x42	3,311	3,632	120	160	31
	H5	F	15x75x42	3,556	3,899	132	175	34

FLUTED-V
Edge also included in pricing:
Saga-V

CONCORD-V
Edge also included in pricing:
Victory-V

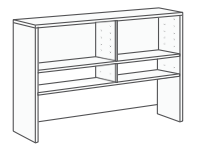
Hutch Open w/Adjustable Shelves								
	H6	A	14x33x49	1,586	1,739	78	120	18
	H6	B	14x45x49	1,688	1,850	89	130	21
	H6	C	14x57x49	2,060	2,259	102	140	24
	H6	D	14x63x49	2,245	2,462	114	145	28
	H6	E	14x69x49	2,430	2,666	122	155	32
	H6	F	14x75x49	2,621	2,873	135	170	36

NOTE
High profile furniture should be anchored to the credenza or desk top with provided dowels or metal brackets

Hutches have 20" clearance from the fixed shelf to the work surface, and a 2" gap for wire management

Hutch Hinged Doors w/Fixed Shelf								
	H7	A	14x33x49	1,945	2,133	78	130	18
	H7	B	14x45x49	2,291	2,514	89	140	21
	H7	C	14x57x49	2,826	3,099	102	150	24
	H7	D	14x63x49	3,095	3,394	114	155	28
	H7	E	14x69x49	3,364	3,688	122	165	32
	H7	F	14x75x49	3,631	3,980	135	180	36

TASK LIGHTS
23" Silver Metal: \$255 list

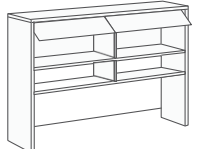
Hutch Garage Doors w/Fixed Shelf								
	H8	A	15x33x49	2,062	2,261	78	130	18
	H8	B	15x45x49	2,469	2,710	89	140	21
	H8	C	15x57x49	3,004	3,294	102	150	24
	H8	D	15x63x49	3,273	3,588	114	155	28
	H8	E	15x69x49	3,542	3,884	122	165	32
	H8	F	15x75x49	3,808	4,177	135	180	36

GLASS DOORS
Frosted Glass Doors (set of 2): \$331 list

Not available for H8 hutch

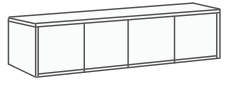
Wall-Mount Overhead								
	H9	A	15x36x15	1,819	1,993	86	62	5
	H9	B	15x48x15	2,104	2,307	101	84	7
	H9	C	15x60x15	2,392	2,622	112	106	8
	H9	D	15x66x15	2,535	2,780	120	117	9
	H9	E	15x72x15	2,679	2,936	132	128	10
	H9	F	15x78x15	3,060	3,357	142	140	11

MAIL SORTER
Add \$364 list for mail sorter
Will reduce clearance from work surface by 5"

HINGED DOOR
H7A, H7B, H9A, and H9B come with 2 hinged doors; all others come with 4 hinged doors

WALL-MOUNT OVERHEAD

Licensed installers are recommended to install wall-mounted furniture. Installers must provide fasteners.

WALL-MOUNT OVERHEAD

Add \$339 list for garage doors

TACKBOARDS

See page #26 for tackboards

GARAGE DOOR

H8A, H8B, H9A, and H9B come with 1 garage door; all others come with 2 garage doors

RECEPTIONS

[Back to main Tables of Contents](#)

Click text to jump page

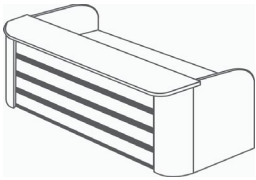
<i>pg. 259</i>	<u>Le FANTOME</u>	
<i>pg. 267</i>	<u>UNIVERSAL</u>	

*Curved and Stacked Reception Units per quote.
Contact a Rep from Faustinos.*

[Back to main Table of Contents](#)

Click text to jump page

<i>pg. 260</i>	<u>LAMINATE W/WOOD EDGE</u>
<i>pg. 263</i>	<u>WOOD VENEER</u>

TABLE OF CONTENTS

Le FANTOME
LAMINATE W/WOOD EDGE

TABLE OF CONTENTS

Click text to jump page

SERIES

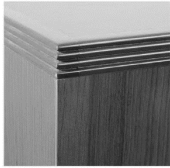
pg. 261	<u>ECHO</u>	 (E)	Included in pricing: BEVELED, SQUARE, MATRIX
pg. 261	<u>FLUTED-L</u>	 (FL)	Included in pricing: SAGA-L



BEVELED
(BL)

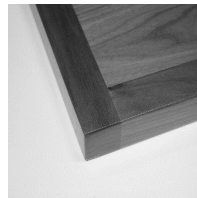

SQUARE
(QL)

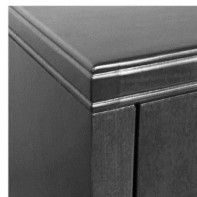

MATRIX
(ML)



SAGA-L
(SL)

TABLE OF CONTENTS

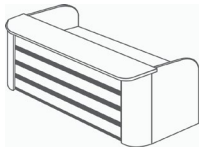
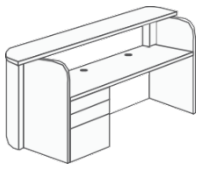
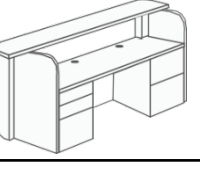
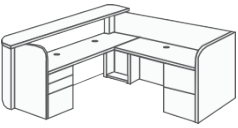
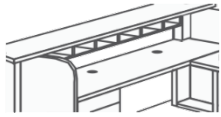
Configuration	Quick Model	Quick Size	Size	Echo	Fluted-L	Carton	B-Weight	Cube
Le Fantome (FRM) Reception Shell								
	R	A	32x66	3,639	3,960	224	130	36
	R	B	32x72	3,768	4,089	224	154	42
	R	C	32x78	3,960	4,283	267	145	43
	R	D	32x84	4,155	4,475	267	165	50
	R	E	32x90	4,615	4,935	335	200	64
	R	F	32x96	5,581	5,932	335	220	68
Le Fantome (FRM) Reception Single Ped								
	SR	A	32x66	4,135	4,454	224	235	42
	SR	B	32x72	4,262	4,584	224	235	42
	SR	C	32x78	4,454	4,776	267	245	50
	SR	D	32x84	4,647	4,970	267	265	54
	SR	E	32x90	5,106	5,427	335	275	64
	SR	F	32x96	6,122	6,476	335	285	68
Le Fantome (FRM) Reception Double Ped								
	DR	A	32x72	4,754	5,077	224	230	38
	DR	B	32x78	4,947	5,272	267	240	40
	DR	C	32x84	5,140	5,461	267	250	40
	DR	D	32x90	5,599	5,921	335	265	42
	DR	E	32x96	6,663	7,016	335	275	46
Le Fantome (FRM) Reception L-Shaped w/Flush Return								
	RFL	A	32X78, 30X48	6,221	6,647	417	230	30
	RFL	B	32X84, 30X48	6,605	7,032	500	250	36
	RFL	C	32X90, 30X48	7,063	7,491	667	270	33
	RFL	D	32X96, 30X48	8,275	8,744	834	290	39
Le Fantome (FRM) Reception Storage Gallery Option								
	RG		Gallery	212	212			

ECHO

Edges also included in pricing:
Beveled, Square, Matrix

FLUTED-L

Edges also included in pricing:
Saga-L

RIGHT OR LEFT

Specify (RP) for Right Pedestal or (LP) for Left Pedestal (LP) and
Specify (R) for Right Return or (L) for Left Return

TABLE OF CONTENTS

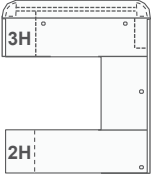
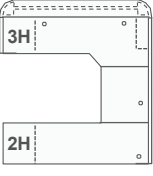
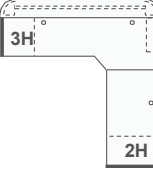
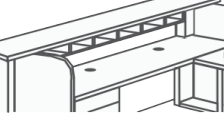
Configuration	Quick Model	Quick Size	Size	Echo	Fluted-L	Carton	B-Weight	Cube
Le Fantome (FRM) Reception U-Shaped								
	RU	A	32x78 Desk 30x48 Bridge 20x78 Credenza	7,842	8,379	667	773	134
Le Fantome (FRM) Reception U-Shaped Computer								
	RCU	A	32-78x44 Desk 30x36 Bridge 20x78 Credenza	8,979	9,515	667	773	134
Le Fantome (FRM) Reception L-Shaped Computer								
	RCL	A	32-78x44 Desk 30x48 Return	7,355	7,889	501	623	126
Le Fantome (FRM) Reception Storage Gallery Option								
	RG		Gallery	212	212			

ECHO

Edges also included in pricing:
Beveled, Square, Matrix

FLUTED-L

Edges also included in pricing:
Saga-L

RIGHT OR LEFT



Specify (RP) for Right Pedestal or (LP) for Left Pedestal (LP) and
Specify (R) for Right Return or (L) for Left Return

NOTE

All "U" shapes on this page have a privacy panel on the bridge and on one side of the credenza only

Click text to jump page

SERIES

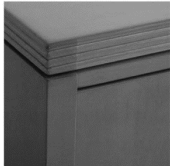
pg. 264	<u>ARISTOCRAT</u>	 (A)	Included in pricing: BEVELED, SQUARE, MATRIX
pg. 264	<u>ROW</u>	 (R)	Included in pricing: ROW 2, ROW-BEVELED, ROW-REVERSE-BEVELED
pg. 264	<u>FLUTED-V</u>	 (FV)	Included in pricing: SAGA-V

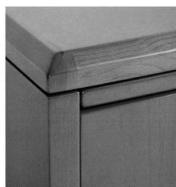

BEVELED
(BV)

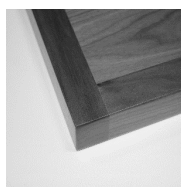

SQUARE
(QV)



MATRIX
(MV)

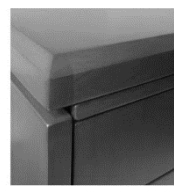

ROW 2
(R2)

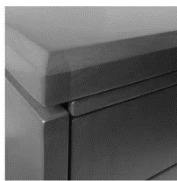

ROW-BEVELED
(RB)

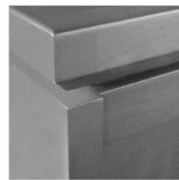

ROW-REVERSED-
BEVELED
(RRB)



SAGA-V
(SV)

TABLE OF CONTENTS

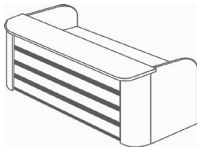
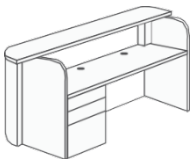
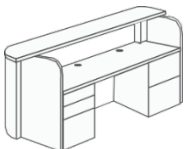
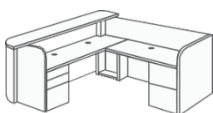
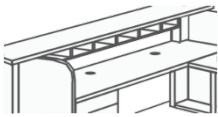
Configuration	Quick Model	Quick Size	Size	Aristocrat	Row	Fluted-V	Carton	B-Weight	Cube
Le Fantome (FRM) Reception Shell									
	R	A	32x66	5,531	5,959	5,852	224	250	52
	R	B	32x72	5,727	6,157	6,050	224	270	56
	R	C	32x78	6,020	6,449	6,343	267	290	61
	R	D	32x84	6,311	6,744	6,636	267	310	66
	R	E	32x90	7,273	7,705	7,595	335	330	70
	R	F	32x96	9,054	9,530	9,411	335	350	75
Le Fantome (FRM) Reception Single Ped									
	SR	A	32x66	6,282	6,710	6,605	224	330	52
	SR	B	32x72	6,476	6,925	6,797	224	350	56
	SR	C	32x78	6,771	7,199	7,091	267	370	61
	SR	D	32x84	7,065	7,707	7,386	267	370	61
	SR	E	32x90	8,025	8,668	8,345	335	430	70
	SR	F	32x96	9,881	10,589	10,236	335	470	75
Le Fantome (FRM) Reception Double Ped									
	DR	A	32x72	7,229	7,677	7,551	224	430	56
	DR	B	32x78	7,521	7,950	7,830	267	450	61
	DR	C	32x84	7,814	8,242	8,135	267	470	66
	DR	D	32x90	8,773	9,201	9,097	335	490	70
	DR	E	32x96	10,706	11,177	11,061	335	510	75
Le Fantome (FRM) Reception L-Shaped w/Flush Return									
	RFL	A	32X78, 30X48	9,455	10,097	9,881	417	678	97
	RFL	B	32X84, 30X48	10,037	10,679	10,465	500	718	106
	RFL	C	32X90, 30X48	10,707	11,684	11,195	667	760	110
	RFL	D	32X96, 30X48	12,565	13,606	13,086	834	800	115
Le Fantome (FRM) Reception Storage Gallery Option									
	RG		Gallery	424	424	424			

ARISTOCRAT

*Edges also included in pricing:
Beveled, Square, Matrix*

ROW

*Edges also included in pricing:
Row 2, Row-Beveled, Row-Reverse-Beveled*

FLUTED-V

*Edges also included in pricing:
Saga-V*

ROW

Add \$558 to R-A through DR-E for Row-Saga or Row-Fluted

RIGHT OR LEFT

Specify (RP) for Right Pedestal or (LP) for Left Pedestal (LP) and Specify (R) for Right Return or (L) for Left Return

NOTE

All "U" shapes on this page have a privacy panel on the bridge and on one side of the credenza only

TABLE OF CONTENTS

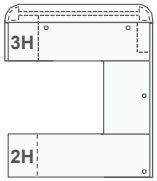
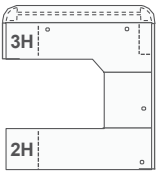
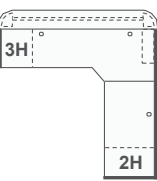
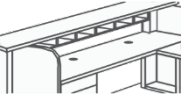
Configuration	Quick Model	Quick Size	Size	Aristocrat	Row	Fluted-V	Carton	B-Weight	Cube
Le Fantome (FRM) Reception U-Shaped									
	RU	A	32x78 Desk 30x48 Bridge 20x78 Credenza	11,923	12,780	12,459	667	773	134
Le Fantome (FRM) Reception U-Shaped Computer									
	RCU	A	32-78x44 Desk 30x36 Bridge 20x78 Credenza	13,648	14,719	14,186	667	773	134
Le Fantome (FRM) Reception L-Shaped Computer									
	RCL	A	32-78x44 Desk 30x48 Return	11,178	12,035	11,606	501	623	126
Le Fantome (FRM) Reception Storage Gallery Option									
	RG		Gallery	424	424	424			

ARISTOCRAT

Edges also included in pricing:
Beveled, Square, Matrix

ROW

Edges also included in pricing:
Row 2, Row-Beveled, Row-Reverse-Beveled

FLUTED-V

Edges also included in pricing:
Saga-V

ROW

Add \$1,134 to RU-A through RCU-A for Row-Saga or Row-Fluted

RIGHT OR LEFT

Specify (RP) for Right Pedestal or (LP) for Left Pedestal (LP) and Specify (R) for Right Return or (L) for Left Return

NOTE

All "U" shapes on this page have a privacy panel on the bridge and on one side of the credenza only

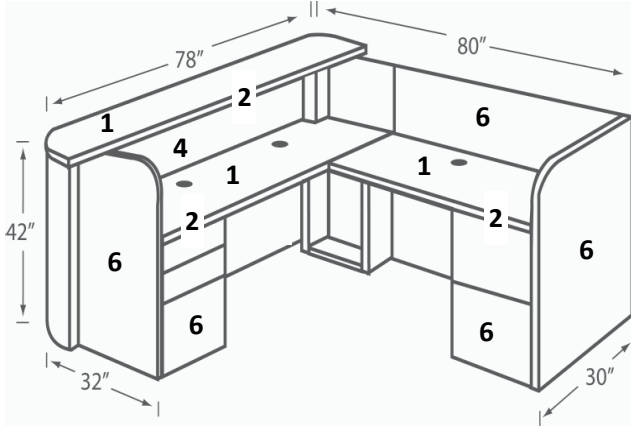

Showing Model RFLA w/Right Return

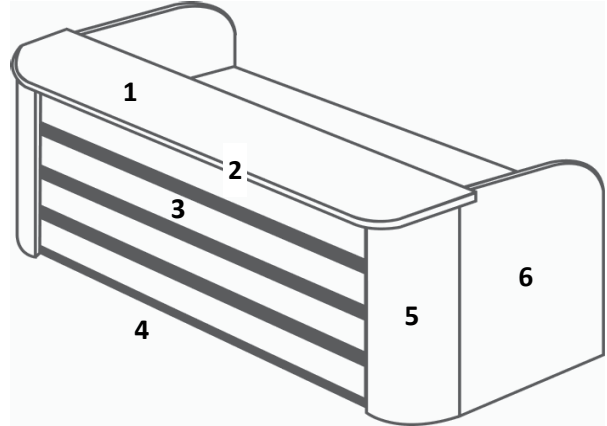

Showing Model RC

FEATURE	FINISH
1) TOPS	
2) SOLID WOOD TRIM	
3) INLAYS (WIDE STRIPS)	
4) MODESTY PANELS (NARROW STRIPS; BLACK IS STANDARD)	
5) COLUMNS	
6) PRIVACY PANELS AND DRAWERS	

TRANSACTION TOP: Please contact rep for pricing and availability

FROSTED GLASS

12"x66"

12"x72"

12"x78"

12"x84"

12"x96"

CLEAR GLASS

12"x66"

12"x72"

12"x78"

12"x84"

12"x96"

Aluminum Planks (set of 4)
Aluminum Columns (set of 2)



[Back to main Table of Contents](#)

Click text to jump page

<i>pg. 268</i>	<u>LAMINATE</u>
<i>pg. 271</i>	<u>LAMINATE W/WOOD EDGE</u>
<i>pg. 274</i>	<u>WOOD VENEER</u>

TABLE OF CONTENTS

UNIVERSAL
LAMINATE

TABLE OF CONTENTS

Click text to jump page
SERIES

<p><i>pg. 269</i></p>	<p><u>PONY</u></p>	 <p>(P)</p>
-----------------------	--------------------	--

TABLE OF CONTENTS

Configuration	Quick Model	Quick Size	Size	Pony	Carton	B-Weight	Cube
Universal (URM) Reception Shell							
	RSS	A	30x66	1,954	224	230	49
	RSS	B	30x72	2,084	224	245	53
	RSS	C	30x78	2,276	267	260	57
	RSS	D	30x84	2,469	267	275	61
Universal (URM) Reception Single Ped							
	GSP	A	30x66	2,276	224	295	49
	GSP	B	30x72	2,404	224	310	53
	GSP	C	30x78	2,598	267	325	57
	GSP	D	30x84	2,791	267	340	61
Universal (URM) Reception Double Ped							
	GDP	A	30x66	2,598	224	360	49
	GDP	B	30x72	2,726	224	375	53
	GDP	C	30x78	2,918	267	390	57
	GDP	D	30x84	3,112	267	405	61
Universal (URM) Reception L-Shaped							
	GL	A	30x66 Desk 24x48 Return	3,876	417	513	77
	GL	B	30x72 24x54	4,200	417	538	85
Universal (URM) Reception U-Shaped							
	GU	A	30x66 Desk 20x48 Bridge 20x66 Credenza	5,064	667	665	106
	GU	B	36x72 24x48 24x72	5,405	667	698	116
Universal (URM) Reception Storage Gallery Option							
	RGR		Gallery	212			

RIGHT OR LEFT

Specify (RP) for Right Pedestal
or (LP) for Left Pedestal (LP)
and
Specify (R) for Right Return or
(L) for Left Return

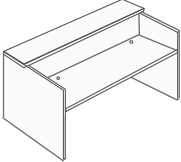
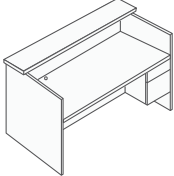
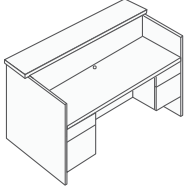
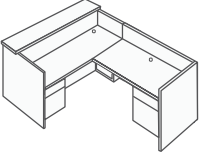
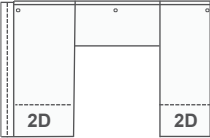
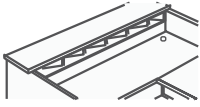
FULL PED

Add \$182 list each to convert
Box/File (2D) to File/File (2H) or
Box/Box/File (3H) pedestal

NOTE

All "U" shapes on this page
have a privacy panel on the
bridge and on one side of the
credenza only

TABLE OF CONTENTS

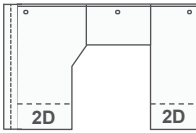
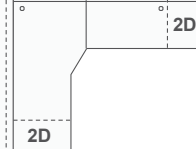
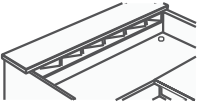
Configuration	Quick Model	Quick Size	Size	Pony	Carton	B-Weight	Cube
Universal (URM) Reception U-Shaped Computer							
	GR	A	30-72x42 Desk 20x42 Bridge 20x72 Credenza	5,966	605	698	130
	GR	B	36-78x48 24x42 24x72	6,434	605	728	151
Universal (URM) Reception L-Shaped Computer							
	GRL	A	36-72x42 Desk 24x48 Return	4,649	377	553	102
	GRL	B	36-78x48 24x54	5,273	454	583	119
Universal (URM) Reception Storage Gallery Option							
	RG		Gallery	212			

RIGHT OR LEFT

Specify (RP) for Right Pedestal
or (LP) for Left Pedestal (LP)
and
Specify (R) for Right Return or
(L) for Left Return

FULL PED

Add \$182 list each to convert
Box/File (2D) to File/File (2H) or
Box/Box/File (3H) pedestal

NOTE

All "U" shapes on this page
have a privacy panel on the
bridge and on one side of the
credenza only

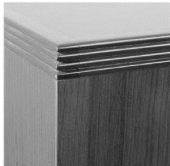

TABLE OF CONTENTS

UNIVERSAL
LAMINATE W/WOOD EDGE

TABLE OF CONTENTS

Click text to jump page

SERIES

pg. 272	<u>ECHO</u>	 (E)	Included in pricing: BEVELED, SQUARE, MATRIX
pg. 272	<u>FLUTED-L</u>	 (FL)	Included in pricing: SAGA-L
pg. 272	<u>CONCORD-L</u>	 (CL)	



BEVELED
(BL)



SQUARE
(QL)

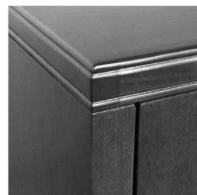

MATRIX
(ML)

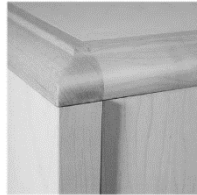

SAGA-L
(SL)

TABLE OF CONTENTS

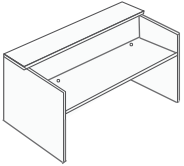
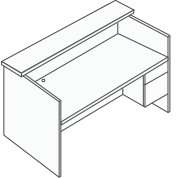
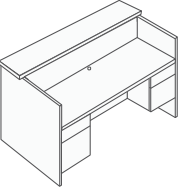
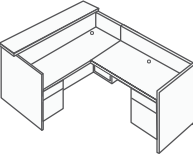
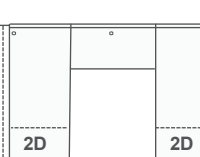
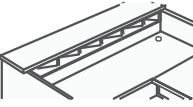
Configuration	Quick Model	Quick Size	Size	Echo	Fluted-L	Concord-L	Carton	B-Weight	Cube
Universal (URM) Reception Shell									
	RSS	A	30x66	2,276	2,490	3,872	224	230	49
	RSS	B	30x72	2,404	2,621	4,008	224	245	53
	RSS	C	30x78	2,598	2,811	4,210	267	260	57
	RSS	D	30x84	2,791	3,005	4,412	267	275	61
Universal (URM) Reception Single Ped									
	GSP	A	30x66	2,598	2,582	4,210	224	295	49
	GSP	B	30x72	2,726	2,942	4,346	224	310	53
	GSP	C	30x78	2,918	3,134	4,546	267	325	57
	GSP	D	30x84	3,112	3,328	4,752	267	340	61
Universal (URM) Reception Double Ped									
	GDP	A	30x66	2,918	3,006	4,546	224	360	49
	GDP	B	30x72	3,048	3,261	4,681	224	375	53
	GDP	C	30x78	3,240	3,454	4,884	267	390	57
	GDP	D	30x84	3,432	3,649	5,088	267	405	61
Universal (URM) Reception L-Shaped									
	GL	A	30x66 Desk 24x48 Return	4,328	4,650	6,370	416	513	77
	GL	B	30x72 24x54	4,650	4,971	6,717	416	538	85
Universal (URM) Reception U-Shaped									
	GU	A	30x66 Desk 20x48 Bridge 20x66 Credenza	5,642	6,071	7,991	667	665	106
	GU	B	36x72 24x48 24x72	5,986	6,414	8,351	667	698	116
Universal (URM) Reception Storage Gallery Option									
	RGR		Gallery	212	212	222			

ECHO

Edges also included in pricing:
Beveled, Square, Matrix

FLUTED-L

Edges also included in pricing:
Saga-L

RIGHT OR LEFT

Specify (RP) for Right Pedestal or (LP) for Left Pedestal (LP) and Specify (R) for Right Return or (L) for Left Return

FULL PED

Add \$182 list each to convert Box/File (2D) to File/File (2H) or Box/Box/File (3H) pedestal

NOTE

All "U" shapes on this page have a privacy panel on the bridge and on one side of the credenza only

TABLE OF CONTENTS

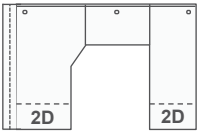
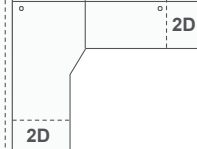
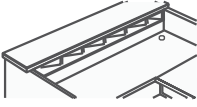
Configuration	Quick Model	Quick Size	Size	Echo	Fluted-L	Concord-L	Carton	B-Weight	Cube
Universal (URM) Reception U-Shaped Computer									
	GR	A	30-72x42 Desk 20x42 Bridge 20x72 Credenza	6,543	6,973	8,938	667	698	130
	GR	B	36-78x48 24x42 24x72	7,015	7,444	9,428	667	728	151
Universal (URM) Reception L-Shaped Computer									
	GRL	A	36-72x42 Desk 24x48 Return	5,098	5,422	7,187	416	553	102
	GRL	B	36-78x48 24x54	5,722	6,042	7,838	501	583	119
Universal (URM) Reception Storage Gallery Option									
	RG		Gallery	212	212	222			

ECHO

Edges also included in pricing:
Beveled, Square, Matrix

FLUTED-L

Edges also included in pricing:
Saga-L

RIGHT OR LEFT

Specify (RP) for Right Pedestal or (LP) for Left Pedestal (LP) and
Specify (R) for Right Return or (L) for Left Return

FULL PED

Add \$182 list each to convert Box/File (2D) to File/File (2H) or Box/Box/File (3H) pedestal

NOTE

All "U" shapes on this page have a privacy panel on the bridge and on one side of the credenza only

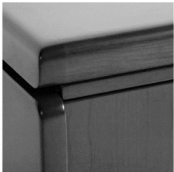
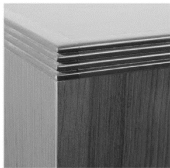

TABLE OF CONTENTS

UNIVERSAL
WOOD VENEER

TABLE OF CONTENTS

Click text to jump page

SERIES

pg. 275	<u>ARISTOCRAT</u>	 (A)	Included in pricing: BEVELED, SQUARE, MATRIX
pg. 275	<u>ROW</u>	 (R)	Included in pricing: ROW 2, ROW-BEVELED, ROW-REVERSE-BEVELED
pg. 275	<u>FLUTED-V</u>	 (FV)	Included in pricing: SAGA-V
pg. 275	<u>CONCORD-V</u>	 (CV)	

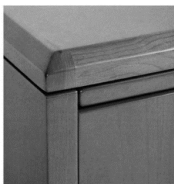

BEVELED
(BV)

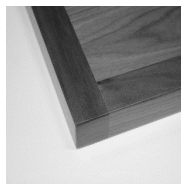

SQUARE
(QV)



MATRIX
(MV)

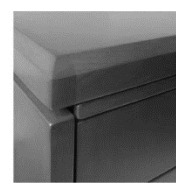

ROW 2
(R2)

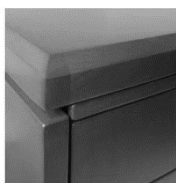

ROW-BEVELED
(RB)

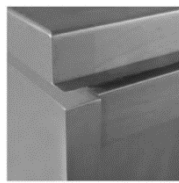

ROW-REVERSED-
BEVELED
(RRB)



SAGA-V
(SV)

TABLE OF CONTENTS

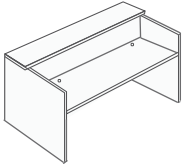
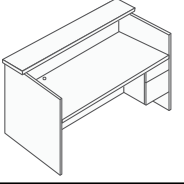
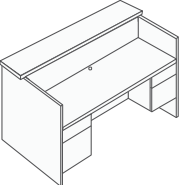
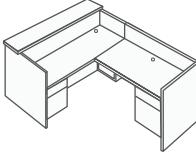
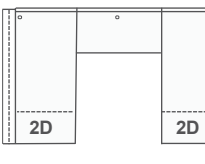
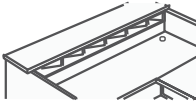
Configuration	Quick Model	Quick Size	Size	Aristocrat	Row	Fluted-V	Concord-V	Carton	B-Weight	Cube
Universal (URM) Reception Shell										
	RSS	A	30x66	3,456	3,884	3,779	5,226	246	230	49
	RSS	B	30x72	3,655	4,082	3,977	5,433	246	245	53
	RSS	C	30x78	3,975	4,401	4,294	5,763	291	260	57
	RSS	D	30x84	4,269	4,695	4,589	6,072	291	275	61
Universal (URM) Reception Single Ped										
	GSP	A	30x66	3,946	4,373	4,269	5,738	246	295	49
	GSP	B	30x72	4,144	4,570	4,465	5,943	246	310	53
	GSP	C	30x78	4,467	4,895	4,788	6,281	291	325	57
	GSP	D	30x84	4,760	5,189	5,085	6,591	291	340	61
Universal (URM) Reception Double Ped										
	GDP	A	30x66	4,424	4,852	4,747	6,238	246	360	49
	GDP	B	30x72	4,633	5,060	4,954	6,455	246	375	53
	GDP	C	30x78	4,957	5,388	5,280	6,795	291	390	57
	GDP	D	30x84	5,255	5,682	5,576	7,107	291	405	61
Universal (URM) Reception L-Shaped										
	GL	A	30x66 Desk 24x48 Return	6,620	7,261	7,050	8,895	417	513	77
	GL	B	30x72 24x54	7,114	7,756	7,542	9,402	550	538	85
Universal (URM) Reception U-Shaped										
	GU	A	30x66 Desk 20x48 Bridge 20x66 Credenza	8,749	9,604	9,285	11,117	711	665	106
	GU	B	36x72 24x48 24x72	9,278	10,133	9,815	11,915	711	698	116
Universal (URM) Reception Storage Gallery Option										
	RGR		Gallery	449	449	449	470			

ARISTOCRAT
Edges also included in pricing:
Beveled, Square, Matrix

ROW
Edges also included in pricing:
Row 2, Row-Beveled, Row-Reverse-Beveled

FLUTED-V
Edges also included in pricing:
Saga-V

ROW
Add \$485 to RS-SA through GD-PD for Row-Saga or Row-Fluted

Add \$841 to GL-A or GL-B for Row-Saga or Row Fluted

Add \$1,031 to GU-A or GU-B for Row-Saga or Row Fluted

RIGHT OR LEFT
Specify (RP) for Right Pedestal or (LP) for Left Pedestal (LP) and Specify (R) for Right Return or (L) for Left Return

FULL PED
Add \$182 list each to convert Box/File (2D) to File/File (2H) or Box/Box/File (3H) pedestal

NOTE
All "U" shapes on this page have a privacy panel on the bridge and on one side of the credenza only

TABLE OF CONTENTS

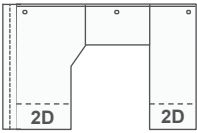
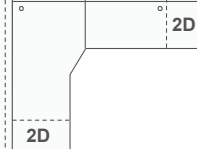
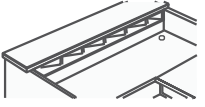
Configuration	Quick Model	Quick Size	Size	Aristocrat	Row	Fluted-V	Concord-V	Carton	B-Weight	Cube
Universal (URM) Reception U-Shaped Computer										
	GR	A	30-72x42 Desk 20x42 Bridge 20x72 Credenza	10,010	10,867	10,547	12,437	732	698	130
	GR	B	36-78x48 24x42 24x72	10,734	11,591	11,270	13,203	732	728	151
Universal (URM) Reception L-Shaped Computer										
	GRL	A	36-72x42 Desk 24x48 Return	7,804	8,447	8,233	10,132	457	553	102
	GRL	B	36-78x48 24x54	8,754	9,396	9,183	11,127	550	583	119
Universal (URM) Reception Storage Gallery Option										
	RG		Gallery	449	449	449	470			

ARISTOCRAT
Edges also included in pricing:
Beveled, Square, Matrix

ROW
Edges also included in pricing:
Row 2, Row-Beveled, Row-Reverse-Beveled

FLUTED-V
Edges also included in pricing:
Saga-V

ROW
Add \$1,134 to GR-A through GR-B for Row-Saga or Row-Fluted

Add \$850 to GR-LA or GR-LB for Row-Saga or Row Fluted

NOTE
All "U" shapes on this page have a privacy panel on the bridge and on one side of the credenza only









FULL PED
Add \$182 list each to convert Box/File (2D) to File/File (2H) or Box/Box/File (3H) pedestal

RIGHT OR LEFT
Specify (RP) for Right Pedestal or (LP) for Left Pedestal (LP) and Specify (R) for Right Return or (L) for Left Return

TABLES

PRODUCT BREAKDOWN

Laminate | Laminate w/Wood Edge | Wood Veneer

 <p><i>PONY</i></p> <p><i>1 SELECTION</i></p>	<p>LAMINATE</p>
   <p><i>ECHO</i> <i>FLUTED-L</i> <i>VICTORY-L</i></p> <p><i>8 SELECTIONS</i></p>	<p>LAMINATE W/WOOD EDGE</p>
    <p><i>ARISTOCRAT</i> <i>ROW</i> <i>FLUTED-V</i> <i>VICTORY-V</i></p> <p><i>14 SELECTIONS</i></p>	<p>WOOD VENEER</p>

[Back to main Tables of Contents](#)

Click text to jump page

<i>pg. 280</i>	<u>LAMINATE</u>
<i>pg. 288</i>	<u>LAMINATE W/WOOD EDGE</u>
<i>pg. 295</i>	<u>WOOD VENEER</u>

[Back to main Table of Contents](#)

Click text to jump page

SERIES

<p><i>pg. 281</i></p>	<p><u>PONY</u></p>	 <p>(P)</p>
-----------------------	--------------------	--

Click text or image to jump page



<i>pg. 282</i>	<u>CONFERENCE</u>	
<i>pg. 283</i>	<u>TOPS</u>	
<i>pg. 284</i>	<u>BASES</u>	
<i>pg. 286</i>	<u>OCCASIONAL</u>	

TABLE OF CONTENTS

Configuration	Quick Model	Quick Size	Size	Pony	Carton	B-Weight	Cube
Boat-Shaped w/Panel End Legs							
	B1	A	30-36x72-2PE	1,107	449	139	15
	B2	B	36-42x84-2PE	1,205	449	182	19
	B3	C	42-48x96-2PE	1,400	449	214	20
	B4	D	42-48x120-3PE	2,047	551	250	24
	B2P	E	42-48x144-3PE	3,136	551	286	26

Racetrack w/Panel End Legs							
	R6	A	36x72-2PE	1,203	449	139	15
	R6	B	42x84-2PE	1,395	449	182	19
	R6	C	48x96-2PE	1,486	449	214	20
	R6	D	48x120-3PE	2,163	551	250	24
	R2P	E	48x144-3PE	3,320	551	286	26

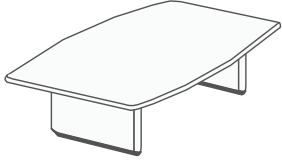
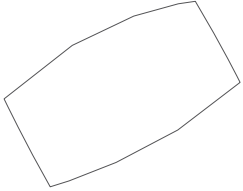
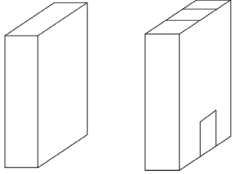
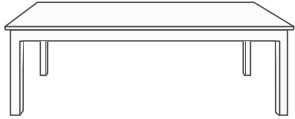
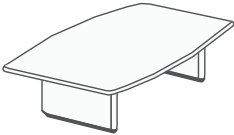
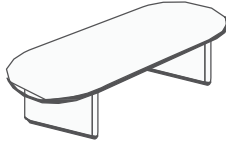
Round Table w/Tapered Legs							
	RTL	A	36	1,533	358	75	19
	RTL	B	42	1,649	358	90	20
	RTL	C	48	1,816	358	105	21
	RTL	D	60	2,954	358	135	23

Round Table w/Cross Base							
	RX	A	36	795	358	85	13
	RX	B	42	910	358	102	17
	RX	C	48	1,130	358	119	18
	RX	D	60	1,401	358	174	25

Round Table w/Full Sculpture Base							
	RDSX	A	36	906	358	105	15
	RDSX	B	42	1,071	358	122	16
	RDSX	C	48	1,243	358	164	18
	RDSX	D	60	1,514	358	290	39

Round Table w/Full Cylinder Base							
	RFC	A	42	1,598	358	85	13
	RFC	B	48	1,816	358	102	17
	RFC	C	60	2,954	358	119	18

TOP
Pony tops are 2" thick

NOTE
B2P and R2P are 2-piece tops and come with 4 stretcher bars

TAPERED LEGS
RTL-D has 3"x3" tapered wood legs



CROSS BASE
Made with self edge laminate

FULL CYLINDER BASE
RFC-C has 30" full cylinder base

OPTIONAL POWER MODULE
DAPO2: \$667 List

Cutout included, provide drawing specifying location

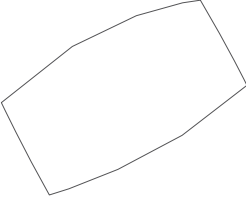
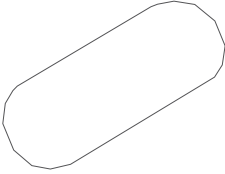
TABLE OF CONTENTS

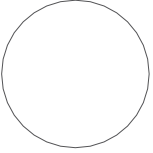
Configuration	Quick Model	Quick Size	Size	Pony	Carton	B-Weight	Cube
Boat-Shaped Top							
	BT	A	30-36x72	711	244	85	9
	BT	B	36-42x84	809	244	112	11
	BT	C	42-48x96	908	244	144	12
	BT	D	42-48x120	1,307	244	180	16
	BT2P	E	42-48x144	2,191	244	216	18
Racetrack Top							
	RT	A	36x72	807	244	85	9
	RT	B	42x84	903	244	112	11
	RT	C	48x96	992	244	144	12
	RT	D	48x120	1,425	244	180	16
	RT2P	E	48x144	2,373	244	216	18
Rectangular Top							
	SQ	A	36x72	649	244	85	9
	SQ	B	42x84	753	244	112	11
	SQ	C	48x96	859	244	144	12
	SQ	D	48x120	1,283	244	180	16
	SQ2P	E	48x144	2,011	244	216	18
Round Top							
	RD	A	36	549	244	45	6
	RD	B	42	667	244	55	7
	RD	C	48	834	244	72	8
	RD	D	60	1,059	244	114	10

TOP
Pony tops are 2" thick

NOTE
BT2P, RT2P, and SQ2P are
2-piece tops

CUSTOM CUTOUT
Add \$223 list for cutout data
port

OPTIONAL POWER MODULE
DAPO2: \$667 List

Cutout included, provide drawing
specifying location

OPTIONAL STRETCHER BAR
\$143 List ea.

TABLE OF CONTENTS





Configuration	Quick Model	Quick Size	Size	Price	Carton	B-Weight	Cube
Panel End Base							
 <p>PE PEDAs</p>	PE	A	3.5x20	195	100	27	3
	PE	B	3.5x24	248	100	35	4
	PE	C	3.5x30	294	100	42	5
	PE	D	7x20	397	125	30	4
	PE	E	7x24	461	125	38	5
	PE	F	7x30	522	125	45	6
	PEDA	G	7x20	711	125	30	4
	PEDA	H	7x24	772	125	38	5
	PEDA	I	7x30	834	125	45	6
Elliptical Base							
 <p>ELB ELBDAs</p>	ELB	A	4-12x20	909	105	60	5
	ELB	B	6-14x24	1,101	133	70	7
	ELB	C	6-16x30	1,292	173	80	8
	ELBD	D	4-12x20	1,454	105	60	5
	ELBD	E	6-14x24	1,643	133	70	7
	ELBD	F	6-16x30	1,836	173	80	8
Full Cylinder Base							
 <p>FC FCDA</p>	FC	A	21	860	100	60	8
	FCDA	B	21	1,404	100	60	8
	FC	C	30	1,723	152	80	15
	FCDA	D	30	2,268	152	80	15
Half Cylinder Base							
 <p>HC HCDA</p>	HC	A	21	616	100	40	6
	HCDA	B	21	1,158	100	40	6
	HC	C	30	1,360	152	60	8
	HCDA	D	30	1,902	152	60	8
Sculpted Cross Base							
	SXB	A	20	356	129	40	7
	SXB	B	24	408	129	47	10
	SXB	C	30	456	129	60	15
Sculpted "T" Base							
	STB	A	20X12	250	96	21	4
	STB	B	24X12	298	96	28	5
	STB	C	30X12	344	96	37	6
Cross Base							
	XB	A	20	270	117	40	7
	XB	B	24	321	117	47	10
	XB	C	30	370	117	60	15

TABLE OF CONTENTS

Configuration	Quick Model	Quick Size	Size	Price	Carton	B-Weight	Cube
T-Leg Tubular Black Metal Base							
	TLB	A	2x18x28	275	38	7	1
	TLB	B	2x22x28	275	38	8	1
	TLB	C	2x26x28	295	38	9	1
	TLBC	D	2x18x28	297	38	7	1
	TLBC	E	2x22x28	297	38	8	1
	TLBC	F	2x26x28	317	38	9	1

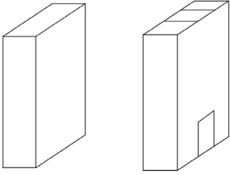
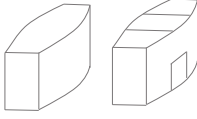
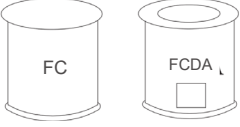
T-LEG TUBULAR
 Max Depth Size Top:
 (A) = 22"
 (B) = 30"
 (C) = 36"

2T Dual Leg Tubular Metal Base – Black							
	2TLB	A	2x22x28	474	38	14	1
	2TLB	B	2x26x28	514	38	16	1
	2TLB	C	2x42x28	555	38	18	1
	2TLBC	D	2x22x28	530	38	14	1
	2TLBC	E	2x26x28	570	38	16	1
	2TLBC	F	2x42x28	610	38	18	1

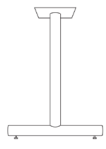
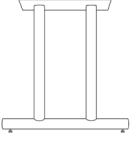
2T DUAL LEG TUBULAR
 Max Depth Size Top:
 (A) = 30"
 (B) = 36"
 (C) = 42"

X-Leg Tubular Metal Base – Black							
	XL30	A	3x26x28	593	38	22	2
	XL36	B	3x32x28	672	38	24	2
	XL48	C	3x42x28	751	38	26	2
	XL30C	D	3x26x28	705	38	22	2
	XL36C	E	3x32x28	785	38	24	2
	XL48C	F	3x42x28	864	38	26	2

X-LEG TUBULAR
 Max Depth Size Top:
 (A) = 30"
 (B) = 42"
 (C) = 48"

Metal Post – Black/Silver							
	MPB	A	5x28	192	34	13	1
	MPS	B	5x28	243	34	13	1

METAL POST
 Laminate wrap = \$499

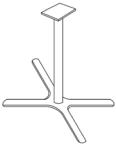
Four-Prong Metal Base – Black							
	4P	A	28	370	38	20	13

FOUR-PRONG
 Max Depth Size Top = 48"

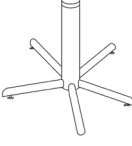
Five-Prong Metal Base w/Wood Clad							
	5VP	A	28	883	38	20	13

- FIVE-PRONG
- Max Depth Size Top = 48"
 - Post Veneer Wrap

TABLE OF CONTENTS

Configuration	Quick Model	Quick Size	Size	Pony	Carton	B-Weight	Cube
Library Table							
	LT	A	24x48x30	972	117	80	21
	LT	B	24x60x30	1,071	117	100	26
	LT	C	24x66x30	1,168	137	110	28
	LT	D	24x72x30	1,268	137	120	32
	LT	E	30x48x30	1,071	137	100	26
	LT	F	30x60x30	1,168	137	110	32
	LT	G	30x66x30	1,268	158	120	36
	LT	H	30x72x30	1,362	158	130	38

TOP
Tops are 1-1/8" thick

LIBRARY TABLE
For center drawer,
add \$212 list

For tapered legs,
add \$263 list

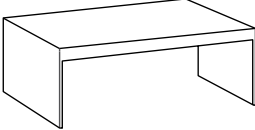
Panel End Coffee Table							
	PET	A	24x24x18	263	101	80	7
	PET	B	30x30x18	306	101	90	9
	PET	C	20x48x18	351	101	100	10
	PET	D	24x48x18	396	101	110	15

4-Wood Legs Coffee & End Table							
	4T	A	24x24x18	584	101	36	7
	4T	B	30x30x18	632	101	46	9
	4T	C	20x48x18	682	101	56	10
	4T	D	24x48x18	730	101	66	15

TABLE OF CONTENTS

Configuration	Quick Model	Quick Size	Size	Price	Carton	B-Weight	Cube
Diameter End Table 1-1/8" Top							
	DT	A	21x18	630	101	55	6
	DT	B	21x26	684	101	62	8
	DT	C	21x29	736	101	68	10
	DT	D	21x18 Kick	761	101	55	6
	DT	E	21x26 Kick	799	101	62	8
	DT	F	21x29 Kick	864	101	68	10

CUBE TABLE
Add \$76 list for black laminate
kick base

Enter (BLK) at the end of quick
code

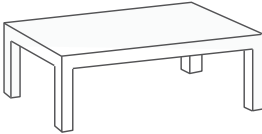
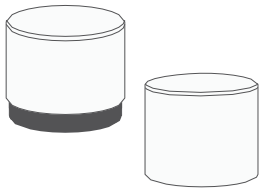
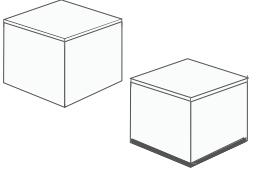
Cube End Table 1-1/8" Top							
	CT1	A	20x20x18	368	87	53	5
	CT1	B	24x24x18	433	87	64	6
	CT1	C	30x30x18	538	112	83	10
	CT1	D	20x48x18	645	112	91	10
	CT1	E	24x48x18	699	112	110	12

Diameter End Table High Pressure Laminate (HPL)							
	DT	A	21x18	751	101	55	6
	DT	B	21x26	805	101	62	8
	DT	C	21x29	858	101	68	10
	DT	D	21x18 Kick	882	101	55	6
	DT	E	21x26 Kick	933	101	62	8
	DT	F	21x29 Kick	986	101	68	10

Cube End Table High Pressure Laminate (HPL)							
	CT1	A	20x20x18	581	87	53	5
	CT1	B	24x24x18	645	87	64	6
	CT1	C	30x30x18	751	112	83	10
	CT1	D	20x48x18	858	112	91	10
	CT1	E	24x48x18	911	112	110	12

TABLE OF CONTENTS

LAMINATE W/WOOD EDGE

[Back to main Table of Contents](#)

Click text to jump page

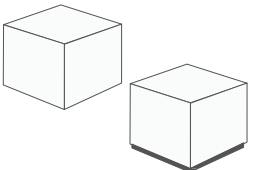
SERIES

pg. 289	ECHO	 (E)	Included in pricing: BEVELED, SQUARE, MATRIX
pg. 289	FLUTED-L	 (FL)	Included in pricing: SAGA-L
pg. 289	VICTORY-L	 (VL)	



BEVELED
(BL)



SQUARE
(QL)



MATRIX
(ML)

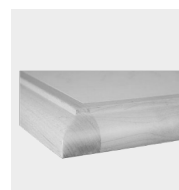

SAGA-L
(SL)

TABLE OF CONTENTS

LAMINATE W/WOOD EDGE

ECHO, FLUTED-L, VICTORY-L

TABLE OF CONTENTS

Click text to jump page



<p><i>pg. 290</i></p>	<p><u>CONFERENCE</u></p>	
<p><i>pg. 291</i></p>	<p><u>TOPS</u></p>	
<p><i>pg. 292</i></p>	<p><u>BASES</u></p>	
<p><i>pg. 294</i></p>	<p><u>OCCASIONAL</u></p>	

TABLE OF CONTENTS

Configuration	Quick Model	Quick Size	Size	Echo	Fluted-L	Victory-L	Carton	B-Weight	Cube
Boat-Shaped w/Panel End Legs									
	B1	A	30-36x72-2PE	1,915	2,160	2,125	449	139	15
	B2	B	36-42x84-2PE	2,114	2,364	2,322	449	182	19
	B3	C	42-48x96-2PE	2,267	2,512	2,477	449	214	20
	B4	D	42-48x120-3PE	3,660	3,905	3,870	551	250	24
	B2P	E	42-48x144-3PE	4,383	4,634	4,593	551	286	26

Racetrack w/Panel End Legs									
	R6	A	36x72-2PE	2,189	2,434	2,189	449	139	15
	R6	B	42x84-2PE	2,669	2,937	2,669	449	182	19
	R6	C	48x96-2PE	3,156	3,402	3,156	449	214	20
	R6	D	48x120-3PE	4,109	4,403	4,109	551	250	24
	R2P	E	48x144-3PE	5,130	5,501	5,130	551	286	26

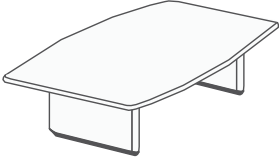
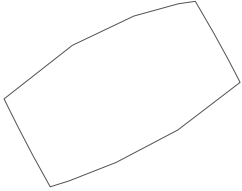
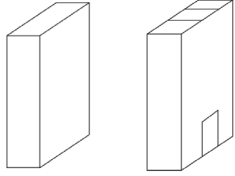
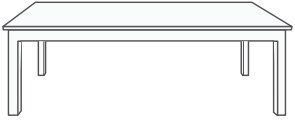
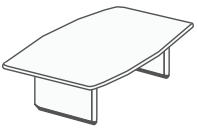
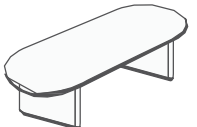
Round Table w/Tapered Legs									
	RTL	A	36	2,357	2,603	2,357	358	75	19
	RTL	B	42	2,534	2,782	2,534	358	90	20
	RTL	C	48	2,684	2,932	2,684	358	105	21
	RTL	D	60	4,035	4,283	4,035	358	135	23

Round Table w/Cross Base									
	RX	A	36	1,641	1,911	1,641	358	85	13
	RX	B	42	1,873	2,115	1,873	358	102	17
	RX	C	48	2,019	2,267	2,019	358	119	18
	RX	D	60	2,510	2,754	2,510	358	174	25

Round Table w/Full Sculpture Base									
	RDSX	A	36	1,938	2,204	1,938	358	105	13
	RDSX	B	42	2,165	2,410	2,165	358	122	17
	RDSX	C	48	2,315	2,565	2,315	358	164	18
	RDSX	D	60	2,807	3,052	2,807	358	290	25

Round Table w/Full Cylinder Base									
	RFC	A	42	2,534	2,656	2,534	358	105	15
	RFC	B	48	2,684	2,932	2,684	358	122	16
	RFC	C	60	4,035	4,283	4,035	358	164	18

ECHO
Edges also included in pricing:
Beveled, Square, Matrix

FLUTED-L
Edge also included in pricing:
Saga-L

TOP
Tops are 1-1/8" thick

NOTE
B2P and R2P are 2-piece tops and come with 4 stretcher bars

TAPERED LEGS
RTL-D has 3"x3" tapered wood legs



CROSS BASE
Made with self edge laminate

FULL CYLINDER BASE
RFC-C has 30" full cylinder base

OPTIONAL POWER MODULE
DAPO2: \$667 List

Cutout included, provide drawing specifying location

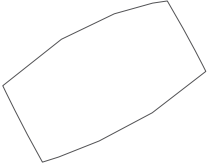
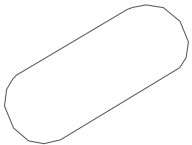
TABLE OF CONTENTS

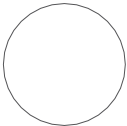
Configuration	Quick Model	Quick Size	Size	Echo	Fluted-L	Victory-L	Carton	B-Weight	Cube
Boat-Shaped Top									
	BT	A	30-36x72	1,244	1,489	1,454	245	85	9
	BT	B	36-42x84	1,350	1,596	1,557	245	112	11
	BT	C	42-48x96	1,499	1,745	1,707	245	144	12
	BT	D	42-48x120	2,509	2,752	2,718	245	180	16
	BT2P	E	42-48x144	3,022	3,271	3,232	245	216	18
Racetrack Top									
	RT	A	36x72	1,521	1,763	1,521	245	85	9
	RT	B	42x84	1,901	2,171	1,901	245	112	11
	RT	C	48x96	2,386	2,634	2,386	245	144	12
	RT	D	48x120	2,958	3,251	2,958	245	180	16
	RT2P	E	48x144	3,770	4,141	3,770	245	216	18
Rectangular Top									
	SQ	A	36x72	1,156	1,422	1,302	245	85	9
	SQ	B	42x84	1,276	1,533	1,412	245	112	11
	SQ	C	48x96	1,430	1,693	1,557	245	144	12
	SQ	D	48x120	2,502	2,762	2,569	245	180	16
	SQ2P	E	48x144	2,876	3,124	3,085	245	216	18
Round Top									
	RD	A	36	1,371	1,641	1,371	245	45	6
	RD	B	42	1,552	1,794	1,552	245	55	7
	RD	C	48	1,698	1,948	1,698	245	72	8
	RD	D	60	2,140	2,386	2,140	245	114	10

ECHO
Edges also included in pricing:
Beveled, Square, Matrix

FLUTED-L
Edge also included in pricing:
Saga-L

VICTORY-L

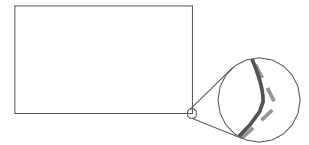
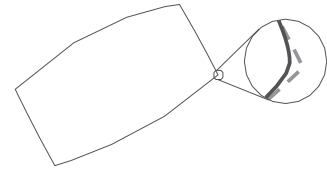

Victory edge has 3/4" rounded corners

NOTE
BT2P, RT2P, and SQ2P are 2-piece tops





CUSTOM CUTOUT
Add \$223 list for cutout data port

OPTIONAL POWER MODULE
DAPO2: \$667 List

Cutout included, provide drawing specifying location

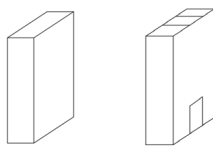
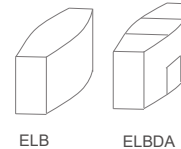
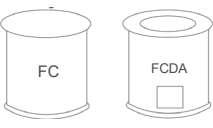
OPTIONAL STRETCHER BAR
\$143 List ea.

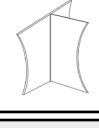
TABLE OF CONTENTS

Configuration	Quick Model	Quick Size	Size	Echo	Concord-L	Carton	B-Weight	Cube
Panel End Base								
 PE PEDA	PE	A	3.5x20	335	441	100	27	3
	PE	B	3.5x24	385	488	100	35	4
	PE	C	3.5x30	434	539	100	42	5
	PE	D	7x20	537	640	125	30	4
	PE	E	7x24	600	703	125	38	5
	PE	F	7x30	662	765	125	45	6
	PEDA	G	7x20	850	953	125	30	4
	PEDA	H	7x24	910	1,016	125	38	5
	PEDA	I	7x30	974	1,080	125	45	6
Elliptical Base								
 ELB ELBDA	ELB	A	4-12x20	1,101	-	106	60	5
	ELB	B	6-14x24	1,293	-	134	70	7
	ELB	C	6-16x30	1,485	-	173	80	8
	ELBD	D	4-12x20	1,643	-	106	60	5
	ELBD	E	6-14x24	1,835	-	134	70	7
	ELBD	F	6-16x30	2,027	-	173	80	8
Full Cylinder Base								
 FC FCDA	FC	A	21	984	1,368	100	60	8
	FCDA	B	21	1,528	1,911	100	60	8
	FC	C	30	1,895	2,278	153	80	15
	FCDA	D	30	2,439	2,823	153	80	15
Half Cylinder Base								
 HC HCDA	HC	A	21	740	1,026	100	40	6
	HCDA	B	21	1,282	1,567	100	40	6
	HC	C	30	1,532	1,820	153	60	8
	HCDA	D	30	2,075	2,363	153	60	8
Sculpted Cross Base								
	SXB	A	20	564	-	129	40	7
	SXB	B	24	616	-	129	47	10
	SXB	C	30	667	-	129	60	15
Sculpted "T" Base								
	STB	A	20X12	469	-	96	21	4
	STB	B	24X12	516	-	96	28	5
	STB	C	30X12	562	-	96	37	6
Cross Base								
	XB	A	20	508	-	117	40	7
	XB	B	24	554	-	117	47	10
	XB	C	30	603	-	117	60	15

ECHO PANEL BASES

Radius wood edge

CONCORD BASES

Floor wood molding

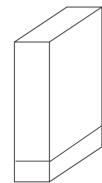
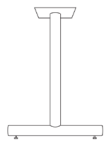



TABLE OF CONTENTS

Configuration	Quick Model	Quick Size	Size	Price	Carton	B-Weight	Cube
T-Leg Tubular Black Metal Base							
	TLB	A	2x18x28	275	38	7	1
	TLB	B	2x22x28	275	38	8	1
	TLB	C	2x26x28	295	38	9	1
	TLBC	D	2x18x28	297	38	7	1
	TLBC	E	2x22x28	297	38	8	1
	TLBC	F	2x26x28	317	38	9	1

T-LEG TUBULAR
 Max Depth Size Top:
 (A) = 22"
 (B) = 30"
 (C) = 36"

2T Dual Leg Tubular Metal Base – Black							
	2TLB	A	2x22x28	474	38	14	1
	2TLB	B	2x26x28	514	38	16	1
	2TLB	C	2x42x28	555	38	18	1
	2TLBC	D	2x22x28	530	38	14	1
	2TLBC	E	2x26x28	570	38	16	1
	2TLBC	F	2x42x28	610	38	18	1

2T DUAL LEG TUBULAR
 Max Depth Size Top:
 (A) = 30"
 (B) = 36"
 (C) = 42"

X-Leg Tubular Metal Base – Black							
	XL30	A	3x26x28	593	38	22	2
	XL36	B	3x32x28	672	38	24	2
	XL48	C	3x42x28	751	38	26	2
	XL30C	D	3x26x28	705	38	22	2
	XL36C	E	3x32x28	785	38	24	2
	XL48C	F	3x42x28	864	38	26	2

X-LEG TUBULAR
 Max Depth Size Top:
 (A) = 30"
 (B) = 42"
 (C) = 48"

Metal Post – Black/Silver							
	MPB	A	5x28	192	34	13	1
	MPS	B	5x28	243	34	13	1

METAL POST
 Laminate wrap = \$499

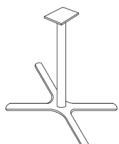

Four-Prong Metal Base – Black							
	4P	A	28	370	38	20	13

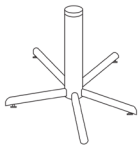
FOUR-PRONG
 Max Depth Size Top = 48"

Five-Prong Metal Base w/Wood Clad							
	5VP	A	28	883	38	20	13

- FIVE-PRONG
- Max Depth Size Top = 48"
 - Post Veneer Wrap

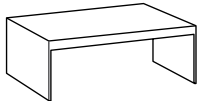
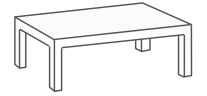
TABLE OF CONTENTS

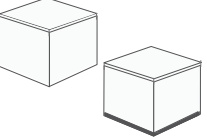
Configuration	Quick Model	Quick Size	Size	Echo	Fluted-L	Victory-L	Carton	B-Weight	Cube
Library Table									
	LT	A	24x48x30	1,362	1,557	-	116	80	21
	LT	B	24x60x30	1,460	1,655	-	116	100	26
	LT	C	24x66x30	1,557	1,751	-	137	110	28
	LT	D	24x72x30	1,655	1,851	-	137	120	32
	LT	E	30x48x30	1,460	1,655	-	137	100	26
	LT	F	30x60x30	1,557	1,751	-	137	110	32
	LT	G	30x66x30	1,655	1,851	-	158	120	36
	LT	H	30x72x30	1,751	1,945	-	158	130	38
Panel End Coffee Table									
	PET	A	24x24x18	399	532	646	102	80	7
	PET	B	30x30x18	441	576	691	102	90	9
	PET	C	20x48x18	485	621	735	102	100	10
	PET	D	24x48x18	532	663	777	102	110	15
4-Wood Leg Coffee & End Table									
	4T	A	24x24x18	683	780	-	102	80	7
	4T	B	30x30x18	730	828	-	102	90	9
	4T	C	20x48x18	780	876	-	102	100	10
	4T	D	24x48x18	828	924	-	102	110	15
Diameter End Table									
	DT	A	21x18	857	956	-	102	55	6
	DT	B	21x26	911	1,008	-	102	62	8
	DT	C	21x29	967	1,062	-	102	68	10
	DT	D	21x18 Kick	986	1,084	-	102	55	6
	DT	E	21x26 Kick	1,037	1,136	-	102	62	8
	DT	F	21x29 Kick	1,093	1,192	-	102	68	10
Cube End Table									
	CT1	A	20x20x18	741	901	1,013	87	53	5
	CT1	B	24x24x18	805	967	1,076	87	64	6
	CT1	C	30x30x18	911	1,073	1,185	113	83	10
	CT1	D	20x48x18	1,017	1,178	1,292	113	91	10
	CT1	E	24x48x18	1,073	1,233	1,346	113	110	12

ECHO
Edges also included in pricing:
Beveled, Square, Matrix

FLUTED-L
Edge also included in pricing:
Saga-L

TOP
Tops are 1-1/8" thick

LIBRARY TABLE
For center drawer, add \$212 list

For tapered legs, add \$263 list

[Back to main Table of Contents](#)

Click text to jump page

SERIES

pg. 296	<u>ARISTOCRAT</u>	 (A)	Included in pricing: BEVELED, SQUARE, MATRIX
pg. 296	<u>ROW</u>	 (R)	Included in pricing: ROW 2, ROW-BEVELED, ROW-REVERSE-BEVELED, ROW-FLUTED*, ROW- SAGA* <small>*Upcharge</small>
pg. 303	<u>FLUTED-V</u>	 (FV)	Included in pricing: SAGA-V
pg. 303	<u>VICTORY-V</u>	 (VV)	



BEVELED
(BV)

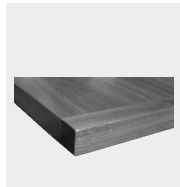

SQUARE
(QV)



MATRIX
(MV)



ROW 2
(R2)



ROW-BEVELED
(RB)



ROW-REVERSED-
BEVELED
(RRB)



SAGA-V
(SV)



ROW-FLUTED
(RF)



ROW-SAGA
(RS)

TABLE OF CONTENTS

WOOD VENEER
ARISTOCRAT & ROW

TABLE OF CONTENTS

Click text to jump page



<i>pg. 297</i>	<u>CONFERENCE</u>	
<i>pg. 298</i>	<u>TOPS</u>	
<i>pg. 299</i>	<u>BASES</u>	
<i>pg. 301</i>	<u>OCCASIONAL</u>	

TABLE OF CONTENTS

Configuration	Quick Model	Quick Size	Size	Aristocrat	Row	Carton	B-Weight	Cube
Boat-Shaped w/Panel End Legs								
	B1	A	30-36x72-2PE	2,396	2,889	449	139	15
	B2	B	36-42x84-2PE	2,566	3,010	449	182	19
	B3	C	42-48x96-2PE	2,975	3,362	449	214	20
	B4	D	42-48x120-3PE	4,382	4,876	551	250	24

ARISTOCRAT
Edges also included in pricing:
Beveled, Square,
Matrix

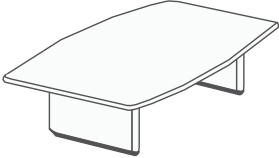
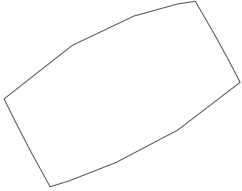
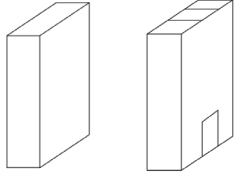
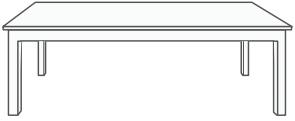
Racetrack w/Panel End Legs								
	R6	A	36x72-2PE	2,674	3,107	449	139	15
	R6	B	42x84-2PE	3,223	3,764	449	182	19
	R6	C	48x96-2PE	3,757	4,119	449	214	20
	R6	D	48x120-3PE	4,863	5,250	551	250	24

ROW
Edge also included in pricing:
Row 2, Row-Beveled
Row-Reversed-Beveled,
Row-Fluted, Row-Saga

Round Table w/Tapered Legs								
	RTL	A	36	2,805	3,298	358	75	19
	RTL	B	42	3,052	3,544	358	90	20
	RTL	C	48	3,217	3,711	358	105	21
	RTL	D	60	4,753	5,243	358	135	23

ROW-FLUTED
Add \$300 List

Round Table w/Cross Base								
	RX	A	36	2,467	2,715	358	105	30
	RX	B	42	2,577	3,067	358	122	36
	RX	C	48	2,743	3,235	358	164	33
	RX	D	60	3,480	3,973	358	290	39

ROW-SAGA
Add \$300 List

Round Table w/Full Sculpture Base								
	RDSX	A	36	2,555	3,049	358	105	13
	RDSX	B	42	2,912	3,402	358	122	17
	RDSX	C	48	3,078	3,569	358	164	18
	RDSX	D	60	3,811	4,305	358	290	25

OPTIONAL POWER MODULE
DAPO2: \$667 List
Cutout included, provide drawing
specifying location

Round Table w/Full Cylinder Base								
	RFC	A	42	3,052	3,544	358	85	13
	RFC	B	48	3,217	3,711	358	102	17
	RFC	C	60	4,753	5,243	358	119	18

OPTIONAL STRETCHER
BAR
\$143 List ea.

Needs 2 per section
between bases for wire
management and strength

TABLE OF CONTENTS

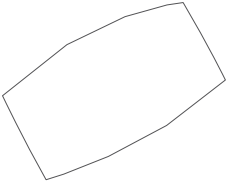
Configuration	Quick Model	Quick Size	Size	Aristocrat	Row	Carton	B-Weight	Cube
Boat-Shaped Top								
	BT	A	30-36x72	1,461	1,897	245	85	9
	BT	B	36-42x84	1,579	2,018	245	112	11
	BT	C	42-48x96	1,988	2,375	245	144	12
	BT	D	42-48x120	2,896	3,391	245	180	16

ARISTOCRAT
Edges also included in pricing:
Beveled, Square,
Matrix

ROW
Edge also included in
pricing:
Row 2, Row-Beveled
Row-Reversed-Beveled,
Row-Fluted, Row-Saga

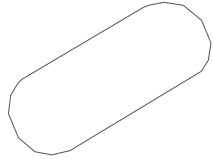
Racetrack Top								
	RT	A	36x72	1,735	2,165	245	85	9
	RT	B	42x84	2,229	2,772	245	112	11
	RT	C	48x96	2,765	3,123	245	144	12
	RT	D	48x120	3,376	3,761	245	180	16

ROW-FLUTED
Add \$300 List

Rectangular Top								
	SQ	A	36x72	1,314	1,700	245	85	9
	SQ	B	42x84	1,430	1,824	245	112	11
	SQ	C	48x96	1,841	2,174	245	144	12
	SQ	D	48x120	2,750	3,193	245	180	16

ROW-SAGA
Add \$300 List

CUSTOM CUTOUT
Add \$223 list for cutout data
port

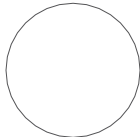
Round Top								
	RD	A	36	1,815	2,308	245	45	6
	RD	B	42	2,062	2,551	245	55	7
	RD	C	48	2,228	2,719	245	72	8
	RD	D	60	2,848	3,338	245	114	10

OPTIONAL POWER MODULE
DAPO2: \$667 List

Cutout included, provide drawing
specifying location

OPTIONAL STRETCHER BAR
\$143 List ea.

TABLE OF CONTENTS







Configuration	Quick Model	Quick Size	Size	Aristocrat	Row	Carton	B-Weight	Cube
Panel End Base								
 <p>PE PEDA</p>	PE	A	3.5x20	465	-	100	69	3
	PE	B	3.5x24	488	-	100	69	4
	PE	C	3.5x30	615	-	100	69	5
	PE	D	7x20	687	-	125	86	4
	PE	E	7x24	749	-	125	86	5
	PE	F	7x30	853	-	125	86	6
	PEDA	G	7x20	1,024	-	125	86	4
	PEDA	H	7x24	1,088	-	125	86	5
	PEDA	I	7x30	1,193	-	125	86	6
Elliptical Base								
 <p>ELB ELBDA</p>	ELB	A	4-12x20	1,149	-	106	60	5
	ELB	B	6-14x24	1,532	-	134	70	7
	ELB	C	6-16x30	1,724	-	173	80	8
	ELBD	D	4-12x20	1,692	-	106	60	5
	ELBD	E	6-14x24	2,075	-	134	70	7
	ELBD	F	6-16x30	2,267	-	173	80	8
Full Cylinder Base								
 <p>FC FCDA</p>	FC	A	21	981	-	100	60	8
	FCDA	B	21	1,524	-	100	60	8
	FC	C	30	1,890	-	153	80	15
	FCDA	D	30	2,432	-	153	80	15
Half Cylinder Base								
 <p>HC HCDA</p>	HC	A	21	737	-	100	40	6
	HCDA	B	21	1,277	-	100	40	6
	HC	C	30	1,526	-	153	60	8
	HCDA	D	30	2,069	-	153	60	8
Sculpted Cross Base								
	SXB	A	20	733	-	125	40	7
	SXB	B	24	839	-	125	47	10
	SXB	C	30	953	-	125	60	15
Sculpted "T" Base								
	STB	A	20X12	575	-	96	21	4
	STB	B	24X12	671	-	96	28	5
	STB	C	30X12	765	-	96	37	6
Cross Base								
	XB	A	20	647	-	117	40	7
	XB	B	24	757	-	117	47	10
	XB	C	30	867	-	117	60	15

TABLE OF CONTENTS

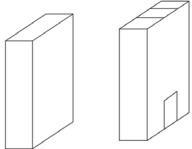
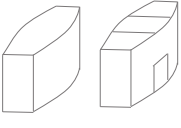
Configuration	Quick Model	Quick Size	Size	Price	Carton	B-Weight	Cube
T-Leg Tubular Black Metal Base							
	TLB	A	2x18x28	275	38	7	1
	TLB	B	2x22x28	275	38	8	1
	TLB	C	2x26x28	295	38	9	1
	TLBC	D	2x18x28	297	38	7	1
	TLBC	E	2x22x28	297	38	8	1
	TLBC	F	2x26x28	317	38	9	1

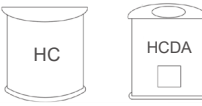
T-LEG TUBULAR
 Max Depth Size Top:
 (A) = 22"
 (B) = 30"
 (C) = 36"

2T Dual Leg Tubular Metal Base – Black							
	2TLB	A	2x22x28	474	38	14	1
	2TLB	B	2x26x28	514	38	16	1
	2TLB	C	2x42x28	555	38	18	1
	2TLBC	D	2x22x28	530	38	14	1
	2TLBC	E	2x26x28	570	38	16	1
	2TLBC	F	2x42x28	610	38	18	1

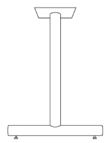
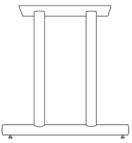
2T DUAL LEG TUBULAR
 Max Depth Size Top:
 (A) = 30"
 (B) = 36"
 (C) = 42"

X-Leg Tubular Metal Base – Black							
	XL30	A	3x26x28	593	38	22	2
	XL36	B	3x32x28	672	38	24	2
	XL48	C	3x42x28	751	38	26	2
	XL30C	D	3x26x28	705	38	22	2
	XL36C	E	3x32x28	785	38	24	2
	XL48C	F	3x42x28	864	38	26	2

X-LEG TUBULAR
 Max Depth Size Top:
 (A) = 30"
 (B) = 42"
 (C) = 48"

Metal Post – Black/Silver							
	MPB	A	5x28	192	34	13	1
	MPS	B	5x28	243	34	13	1

METAL POST
 Laminate wrap = \$499

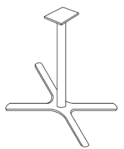
Four-Prong Metal Base – Black							
	4P	A	28	370	38	20	13

FOUR-PRONG
 Max Depth Size Top = 48"

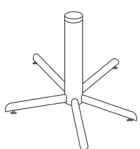
Five-Prong Metal Base w/Wood Clad							
	5VP	A	28	883	38	20	13

- FIVE-PRONG
- Max Depth Size Top = 48"
 - Post Veneer Wrap

TABLE OF CONTENTS

Configuration	Quick Model	Quick Size	Size	Aristocrat	Row	Carton	B-Weight	Cube
Library Table								
	LT	A	24x48x30	1,751	1,945	116	80	21
	LT	B	24x60x30	1,851	2,043	116	100	26
	LT	C	24x66x30	1,945	2,142	137	110	28
	LT	D	24x72x30	2,043	2,239	137	120	32
	LT	E	30x48x30	1,851	2,043	137	100	26
	LT	F	30x60x30	1,945	2,142	137	110	32
	LT	G	30x66x30	2,043	2,239	158	120	36
	LT	H	30x72x30	2,142	2,337	158	130	38

ARISTOCRAT
Edges also included in pricing:
Beveled, Square,
Matrix

ROW
Edge also included in
pricing:
Row 2, Row-Beveled
Row-Reversed-Beveled,
Row-Fluted, Row-Saga

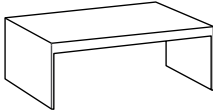
Panel End Coffee Table								
	PET	A	24x24x18	1,073	1,269	102	80	7
	PET	B	30x30x18	1,178	1,373	102	90	9
	PET	C	20x48x18	1,287	1,480	102	100	10
	PET	D	24x48x18	1,393	1,589	102	110	15

ROW-FLUTED
Add \$260 List

ROW-SAGA
Add \$260 List

Diameter End Table								
	DT	A	21x18	1,008	1,205	102	55	6
	DT	B	21x26	1,061	1,261	102	62	8
	DT	C	21x29	1,118	1,318	102	68	10
	DT	D	21x18 Kick	1,138	1,338	102	55	6
	DT	E	21x26 Kick	1,193	1,391	102	62	8
	DT	F	21x29 Kick	1,248	1,448	102	68	10

LIBRARY TABLE
For center drawer,
add \$212 List

For tapered legs,
add \$263 List

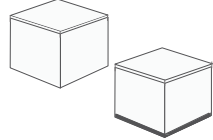
Cube End Table								
	CT1	A	20x20x18	967	1,159	87	53	5
	CT1	B	24x24x18	1,221	1,418	87	64	6
	CT1	C	30x30x18	1,632	1,825	113	83	10
	CT1	D	20x48x18	1,758	1,954	113	91	10
	CT1	E	24x48x18	1,910	2,105	113	110	12









CUBE TABLE
Add \$68 list for black laminate
kick base

Enter (BLK) at the end of quick
code

Add \$149 list for matching
veneer kick base

Enter (MVK) at the end of quick
code

TABLE OF CONTENTS

Configuration	Model	Price	Overall Depth (in)	Overall Width	Top Height	Carton	B-Weight	Cube
End Table								
	5242418	599	24	24	18	106	20	6
	5303018	679	30	30	18	106	23	10
End Table								
	8242418/4	962	24	24	18	106	46	9
	8303018/4	1,059	30	30	18	106	52	10
Corner Table								
	C303018	826	30	30	18	106	24	10
Coffee Table								
	5204818	743	20	48	18	106	28	10
	5244818	830	24	48	18	106	32	12
Coffee Table								
	8204818/4	1,185	20	48	18	106	52	10
	8244818/4	1,270	24	48	18	106	56	12
Tapered End Table								
	8242418	692	24	24	18	106	20	6
	8303018	774	30	30	18	106	23	10
Tapered Coffee Table								
	8204818	887	20	48	18	106	28	10
	8244818	970	24	48	18	106	32	12
Tapered Round End Table								
	81818	879	18	18	18	106	18	6
	82418	1,001	24	24	18	106	20	8
	83018	1,122	30	30	18	106	22	10
Tapered Sofa Table								
	8164830	1,272	16	48	30	106	36	13

DURA-SURFACE
 End Table: add \$191 list
 Sofa Table: add \$254 list
 Coffee Table: add \$381 list

Options: White or Bronze

TABLE OF CONTENTS

WOOD VENEER
FLUTED-V & VICTORY-V

TABLE OF CONTENTS

Click text to jump page



<i>pg. 304</i>	<u>CONFERENCE</u>	
<i>pg. 305</i>	<u>TOPS</u>	
<i>pg. 306</i>	<u>BASES</u>	
<i>pg. 308</i>	<u>OCCASIONAL</u>	

TABLE OF CONTENTS

Configuration	Quick Model	Quick Size	Size	Fluted-V	Victory-V	Carton	B-Weight	Cube
Boat-Shaped w/Panel End Legs								
	B1	A	30-36x72-2PE	2,529	2,496	430	139	15
	B2	B	36-42x84-2PE	2,735	2,653	430	182	19
	B3	C	42-48x96-2PE	3,150	3,045	430	214	20
	B4	D	42-48x120-3PE	4,475	4,392	527	250	24

FLUTED-V
Edges also included in pricing:
Saga-V

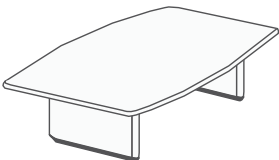
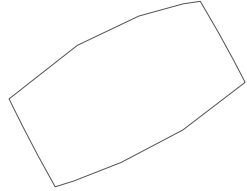
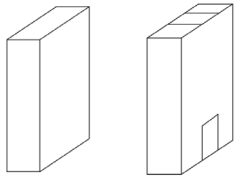
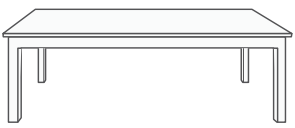
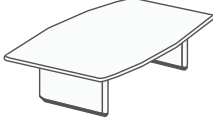
Racetrack w/Panel End Legs								
	R6	A	36x72-2PE	2,791	2,558	430	139	15
	R6	B	42x84-2PE	3,433	3,083	430	182	19
	R6	C	48x96-2PE	3,944	3,594	430	214	20
	R6	D	48x120-3PE	5,015	4,652	527	250	24

OPTIONAL POWER MODULE
DAPO2: \$667 List

Cutout included, provide drawing
specifying location

Round Table w/Tapered Legs								
	RTL	A	36	2,924	2,683	358	75	19
	RTL	B	42	3,154	2,919	358	90	20
	RTL	C	48	3,314	3,077	358	105	21
	RTL	D	60	4,781	4,547	358	135	23

OPTIONAL STRETCHER
BAR
\$143 List ea.

Needs 2 per section
between bases for wire
management and strength

Round Table w/Cross Base								
	RX	A	36	2,597	2,359	358	85	13
	RX	B	42	2,934	2,465	358	102	17
	RX	C	48	3,095	2,824	358	119	18
	RX	D	60	3,837	3,329	358	174	25

Round Table w/Full Sculpture Base								
	RDSX	A	36	2,681	2,444	358	105	13
	RDSX	B	42	3,020	2,786	358	122	17
	RDSX	C	48	3,178	2,944	358	164	18
	RDSX	D	60	3,883	3,646	358	290	25

Round Table w/Full Cylinder Base								
	RFC	A	42	3,089	2,919	358	105	15
	RFC	B	48	3,314	3,077	358	122	16
	RFC	C	60	4,781	4,547	358	164	18

TABLE OF CONTENTS

Configuration	Quick Model	Quick Size	Size	Fluted-V	Victory-V	Carton	B-Weight	Cube
Boat-Shaped Top								
	BT	A	30-36x72	1,633	1,596	234	85	9
	BT	B	36-42x84	1,792	1,709	234	112	11
	BT	C	42-48x96	2,208	2,102	234	144	12
	BT	D	42-48x120	3,053	2,969	234	180	16

FLUTED-V
Edges also included in pricing:
Saga-V

VICTORY-V

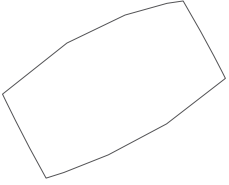
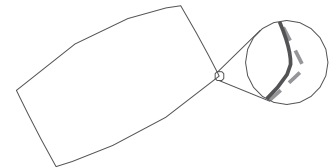

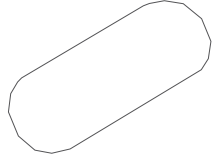
Racetrack Top								
	RT	A	36x72	1,893	1,660	234	85	9
	RT	B	42x84	2,485	2,132	234	112	11
	RT	C	48x96	2,995	2,645	234	144	12
	RT	D	48x120	3,598	3,229	234	180	16

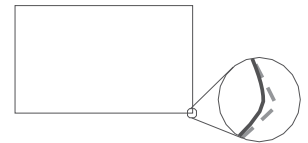

Rectangular Top								
	SQ	A	36x72	1,491	1,455	234	85	9
	SQ	B	42x84	1,605	1,567	234	112	11
	SQ	C	48x96	1,995	1,962	234	144	12
	SQ	D	48x120	2,867	2,828	234	180	16

Victory edge has 3/4" rounded corners

CUSTOM CUTOUT
Add \$223 list for cutout data port

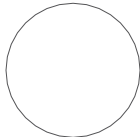



Round Top								
	RD	A	36	1,973	1,736	234	45	6
	RD	B	42	2,208	1,973	234	55	7
	RD	C	48	2,367	2,131	234	72	8
	RD	D	60	2,960	2,725	234	114	10

OPTIONAL POWER MODULE
DAPO2: \$667 List

Cutout included, provide drawing specifying location

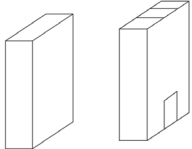
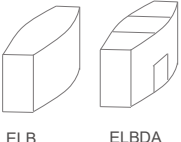
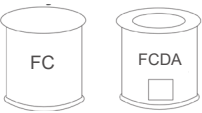
OPTIONAL STRETCHER BAR
\$143 List ea.

TABLE OF CONTENTS

Configuration	Quick Model	Quick Size	Size	Fluted-V	Concord-V	Carton	B-Weight	Cube
Panel End Base								
 <p>PE PEDAs</p>	PE	A	3.5x20	-	538	96	69	3
	PE	B	3.5x24	-	568	96	69	4
	PE	C	3.5x30	-	695	96	69	5
	PE	D	7x20	-	757	120	86	4
	PE	E	7x24	-	817	120	86	5
	PE	F	7x30	-	918	120	86	6
	PEDA	G	7x20	-	1,070	120	86	4
	PEDA	H	7x24	-	1,145	120	86	5
	PEDA	I	7x30	-	1,244	120	86	6
Elliptical Base								
 <p>ELB ELBDAs</p>	ELB	A	4-12x20	-	-		60	5
	ELB	B	6-14x24	-	-		70	7
	ELB	C	6-16x30	-	-		80	8
	ELBD	D	4-12x20	-	-		60	5
	ELBD	E	6-14x24	-	-		70	7
	ELBD	F	6-16x30	-	-		80	8
Full Cylinder Base								
 <p>FC FCDA</p>	FC	A	21	-	-		60	8
	FCDA	B	21	-	-		60	8
	FC	C	30	-	-		80	15
	FCDA	D	30	-	-		80	15
Half Cylinder Base								
 <p>HC HCDA</p>	HC	A	21	-	-		40	6
	HCDA	B	21	-	-		40	6
	HC	C	30	-	-		60	8
	HCDA	D	30	-	-		60	8
Sculpted Cross Base								
	SXB	A	20	-	-		40	7
	SXB	B	24	-	-		47	10
	SXB	C	30	-	-		60	15
Sculpted "T" Base								
	STB	A	20X12	-	-		21	4
	STB	B	24X12	-	-		28	5
	STB	C	30X12	-	-		37	6
Cross Base								
	XB	A	20	-	-		40	7
	XB	B	24	-	-		47	10
	XB	C	30	-	-		60	15

FLUTED-V
Edges also included in pricing:
Saga-V

CONCORD BASES
Floor wood molding

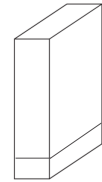
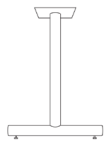



TABLE OF CONTENTS

Configuration	Quick Model	Quick Size	Size	Price	Carton	B-Weight	Cube
T-Leg Tubular Black Metal Base							
	TLB	A	2x18x28	275	38	7	1
	TLB	B	2x22x28	275	38	8	1
	TLB	C	2x26x28	295	38	9	1
	TLBC	D	2x18x28	297	38	7	1
	TLBC	E	2x22x28	297	38	8	1
	TLBC	F	2x26x28	317	38	9	1

T-LEG TUBULAR
 Max Depth Size Top:
 (A) = 22"
 (B) = 30"
 (C) = 36"

2T Dual Leg Tubular Metal Base – Black							
	2TLB	A	2x22x28	474	38	14	1
	2TLB	B	2x26x28	514	38	16	1
	2TLB	C	2x42x28	555	38	18	1
	2TLBC	D	2x22x28	530	38	14	1
	2TLBC	E	2x26x28	570	38	16	1
	2TLBC	F	2x42x28	610	38	18	1

2T DUAL LEG TUBULAR
 Max Depth Size Top:
 (A) = 30"
 (B) = 36"
 (C) = 42"

X-Leg Tubular Metal Base – Black							
	XL30	A	3x26x28	593	38	22	2
	XL36	B	3x32x28	672	38	24	2
	XL48	C	3x42x28	751	38	26	2
	XL30C	D	3x26x28	705	38	22	2
	XL36C	E	3x32x28	785	38	24	2
	XL48C	F	3x42x28	864	38	26	2

X-LEG TUBULAR
 Max Depth Size Top:
 (A) = 30"
 (B) = 42"
 (C) = 48"

Metal Post – Black/Silver							
	MPB	A	5x28	192	34	13	1
	MPS	B	5x28	243	34	13	1

METAL POST
 Laminate wrap = \$499

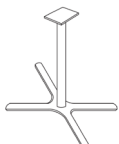
Four-Prong Metal Base – Black							
	4P	A	28	370	38	20	13

FOUR-PRONG
 Max Depth Size Top = 48"

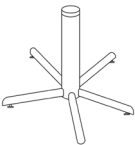
Five-Prong Metal Base w/Wood Clad							
	5VP	A	28	883	38	20	13

- FIVE-PRONG
- Max Depth Size Top = 48"
 - Post Veneer Wrap

TABLE OF CONTENTS

Configuration	Quick Model	Quick Size	Size	Fluted-V	Victory-V	Carton	B-Weight	Cube
Library Table								
	LT	A	24x48x30	1,945	-	116	80	21
	LT	B	24x60x30	2,043	-	116	100	26
	LT	C	24x66x30	2,142	-	137	110	28
	LT	D	24x72x30	2,239	-	137	120	32
	LT	E	30x48x30	2,043	-	137	100	26
	LT	F	30x60x30	2,142	-	137	110	32
	LT	G	30x66x30	2,239	-	158	120	36
	LT	H	30x72x30	2,337	-	158	130	38

FLUTED-V
Edges also included in pricing:
Saga-V

LIBRARY TABLE
For center drawer,
add \$212 list

For tapered legs,
add \$263 list

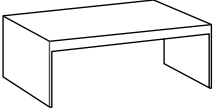
Panel End Coffee Table								
	PET	A	24x24x18	1,178	1,346	102	80	7
	PET	B	30x30x18	1,287	1,452	102	90	9
	PET	C	20x48x18	1,393	1,558	102	100	10
	PET	D	24x48x18	1,500	1,665	102	110	15

CUBE TABLE
Add \$76 list for black laminate
kick base

Enter (BLK) at the end of quick
code

Diameter End Table								
	DT	A	21x18	1,107	-	102	55	6
	DT	B	21x26	1,159	-	102	62	8
	DT	C	21x29	1,216	-	102	68	10
	DT	D	21x18 Kick	1,239	-	102	55	6
	DT	E	21x26 Kick	1,294	-	102	62	8
	DT	F	21x29 Kick	1,351	-	102	68	10

Add \$149 list for matching
veneer kick base

Enter (MVK) at the end of quick
code









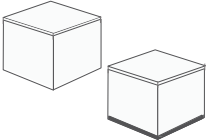

Cube End Table								
	CT1	A	20x20x18	1,062	1,159	87	53	5
	CT1	B	24x24x18	1,318	1,418	87	64	6
	CT1	C	30x30x18	1,729	1,825	113	83	10
	CT1	D	20x48x18	1,858	1,954	113	91	10
	CT1	E	24x48x18	2,006	2,105	113	110	12

TABLE OF CONTENTS

Configuration	Model	Price	Overall Depth (in)	Overall Width	Top Height	Carton	B-Weight	Cube
End Table								
	5242418	599	24	24	18	106	20	6
	5303018	679	30	30	18	106	23	10
End Table								
	8242418/4	962	24	24	18	106	46	9
	8303018/4	1,059	30	30	18	106	52	10
Corner Table								
	C303018	826	30	30	18	106	24	10
Coffee Table								
	5204818	743	20	48	18	106	28	10
	5244818	830	24	48	18	106	32	12
Coffee Table								
	8204818/4	1,185	20	48	18	106	52	10
	8244818/4	1,270	24	48	18	106	56	12
Tapered End Table								
	8242418	692	24	24	18	106	20	6
	8303018	774	30	30	18	106	23	10
Tapered Coffee Table								
	8204818	887	20	48	18	106	28	10
	8244818	970	24	48	18	106	32	12
Tapered Round End Table								
	81818	879	18	18	18	106	18	6
	82418	1,001	24	24	18	106	20	8
	83018	1,122	30	30	18	106	22	10
Tapered Sofa Table								
	8164830	1,272	16	48	30	106	36	13

DURA-SURFACE
End Table: add \$191 list
Sofa Table: add \$254 list
Coffee Table: add \$381 list

Options: White or Bronze

END OF PRICE LIST